

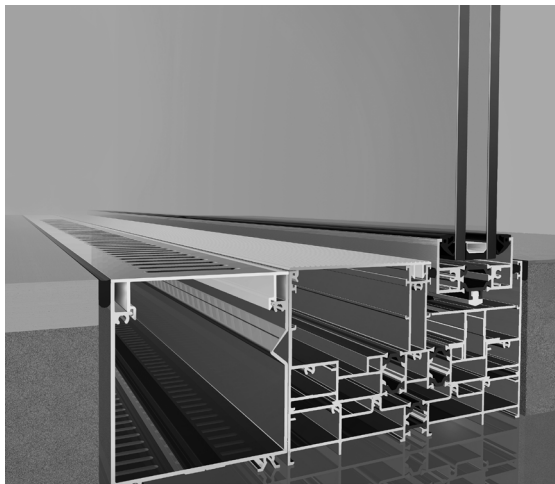

GlobAlum
Globaly Aluminum Passion

**SLIDING SYSTEM
SERIES GSI6OPD**



GSI6OPD

دسته بندی شهرها بر مبنای سرعت باد
گروه یک

City	Wind Velocity Km/h	سرعت باد	نام شهر
TORBAT HEYDARIEH	80		تربت حیدریه
KHORRAM ABAD	80		خرم آباد
ZANJAN	80		زنجان
SEM NAN	80		سمنان
SHAHROUD	80		شاهرود
SHAHRE KORD	80		شهر کرد
SHIRAZ	80		شیراز
GORGAN	80		گرگان

ارتفاع ساختمان از تراز همکف به متر	فشار باد در مناطق داخل شهر		گروه دسته بندی شده بر مبنای فشار باد
	کیلو نیوتن بر متر مربع	پاسکال بر متر مربع	
5	0.48	480	Class 1
10	0.48	480	Class 1
15	0.51	510	Class 1
20	0.56	560	Class 1
25	0.59	590	Class 1
30	0.63	630	Class 2
35	0.66	660	Class 2
40	0.68	680	Class 2
45	0.71	710	Class 2
50	0.73	730	Class 2
55	0.75	750	Class 2
60	0.77	770	Class 2
65	0.79	790	Class 2
70	0.81	810	Class 3
75	0.83	830	Class 3
80	0.84	840	Class 3
85	0.86	860	Class 3
90	0.87	870	Class 3
95	0.89	890	Class 3

دسته بندی شهرها بر مبنای سرعت باد

گروه دو

City	Wind Velocity Km/h	سرعت باد	نام شهر
ARAK	90		اراک
UROMIE	90		ارومیه
ABADAN	90		آبادان
BANDAR LENGEH	90		بندر لنگه
BIRJAND	90		بیرجند
CHABAHAR	90		چابهار
KHOY	90		خوی
RAMSAR	90		رامسر
RASHT	90		رشت
SABZEVAR	90		سبزوار
SANANDAJ	90		سنندج
TABAS	90		طبس
FASA	90		فسا
QA-EM SHAHR	90		قائم شهر
QOM	90		قم
KERMANSHAH	90		کرمانشاه
MASH'HAD	90		مشهد
NOSHAHR	90		نوشهر

ارتفاع ساختمان از تراز همکف به متر	فشار باد در مناطق داخل شهر		گروه دسته بندی شده بر مبنای فشار باد
	کیلو نیوتن بر متر مربع	پاسکال بر متر مربع	
5	0.60	600	Class 1
10	0.60	600	Class 1
15	0.65	650	Class 2
20	0.70	700	Class 2
25	0.75	750	Class 2
30	0.79	790	Class 2
35	0.83	830	Class 3
40	0.87	870	Class 3
45	0.90	900	Class 3
50	0.93	930	Class 3
55	0.95	950	Class 3
60	0.98	980	Class 3

دسته بندی شهرها بر مبنای سرعت باد
گروه سه

City	Wind Velocity Km/h	سرعت باد	نام شهر
ABADEH	100		آباده
BABOLSAR	100		بابلسر
BANDAR ABBAS	100		بندر عباس
BOUSHEHR	100		بوشهر
PARS ABAD MOGHAN	100		پارس آباد مغان
TEHRAN	100		تهران
JASK	100		جاسک
KISH	100		جزیره کیش
SAGHEZ	100		سقز
QAZVIN	100		قزوین
KASHAN	100		کاشان
HAMEDAN	100		همدان

ارتفاع ساختمان از تراز همکف به متر	فشار باد در مناطق داخل شهر		گروه دسته بندی شده بر مبنای فشار باد
	کیلو نیوتن بر متر مربع	پاسکال بر متر مربع	
5	0.74	740	Class 2
10	0.74	740	Class 2
15	0.80	800	Class 2
20	0.87	870	Class 3
25	0.93	930	Class 3
30	0.98	980	Class 3
35	1.03	1030	Class 3
40	1.07	1070	Class 3
45	1.11	1110	Class 3
50	1.14	1140	Class 3
55	1.18	1180	Class 3
60	1.21	1210	Class 4
65	1.24	1240	Class 4
70	1.26	1260	Class 4
75	1.29	1290	Class 4
80	1.32	1320	Class 4
85	1.34	1340	Class 4
90	1.36	1360	Class 4

دسته بندی شهرها بر مبنای سرعت باد
گروه چهار

City	Wind Velocity Km/h	سرعت باد	نام شهر
ISFAHAN	110		اصفهان
OMIDIEH	110		امیدیه
AHWAZ	110		اهواز
IRANSHAHR	110		ایرانشهر
ABALI	110		آبعلی
AGHAJARI	110		آغاجاری
BAM	110		بم
BANDAR ANZALI	110		بندر انزلی
TABRIZ	110		تبریز
SIRI	110		جزیره سیری
DEZFOUL	110		دزفول
SARAKHS	110		سرخس
MARAGHE	110		مراغه
YAZD	110		یزد

ارتفاع ساختمان از تراز همکف به متر	فشار باد در مناطق داخل شهر		گروه دسته بندی شده بر مبنای فشار باد
	کیلو نیوتن بر متر مربع	پاسکال بر متر مربع	
5	0.90	900	Class 3
10	0.90	900	Class 3
15	0.96	960	Class 3
20	1.05	1050	Class 3
25	1.12	1120	Class 3
30	1.19	1190	Class 3
35	1.24	1240	Class 4
40	1.29	1290	Class 4
45	1.34	1340	Class 4
50	1.38	1380	Class 4
55	1.42	1420	Class 4
60	1.46	1460	Class 4
65	1.50	1500	Class 4
70	1.53	1530	Class 4
75	1.56	1560	Class 4
80	1.59	1590	Class 4

دسته بندی شهرها بر مبنای سرعت باد

گروه پنج

City	Wind Velocity Km/h	سرعت باد	نام شهر
ZABOL	120		زابل
ARDEBIL	130		اردبیل
BOJNOURD	130		بجنورد
ZAHEDAN	130		زاهدان
KERMAN	130		کرمان
MANJIL	130		منجیل

ارتفاع ساختمان از تراز همکف به متر	فشار باد در مناطق داخل شهر		گروه دسته بندی شده بر مبنای فشار باد
	کیلو نیوتن بر متر مربع	پاسکال بر متر مربع	
5	1.26	1260	Class 4
10	1.26	1260	Class 4
15	1.35	1350	Class 4
20	1.47	1470	Class 4
25	1.57	1570	Class 4
30	1.66	1660	Class 5
35	1.74	1740	Class 5
40	1.81	1810	Class 5
45	1.87	1870	Class 5
50	1.93	1930	Class 5
55	1.99	1990	Class 5

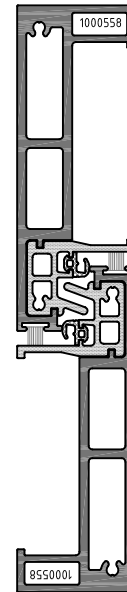
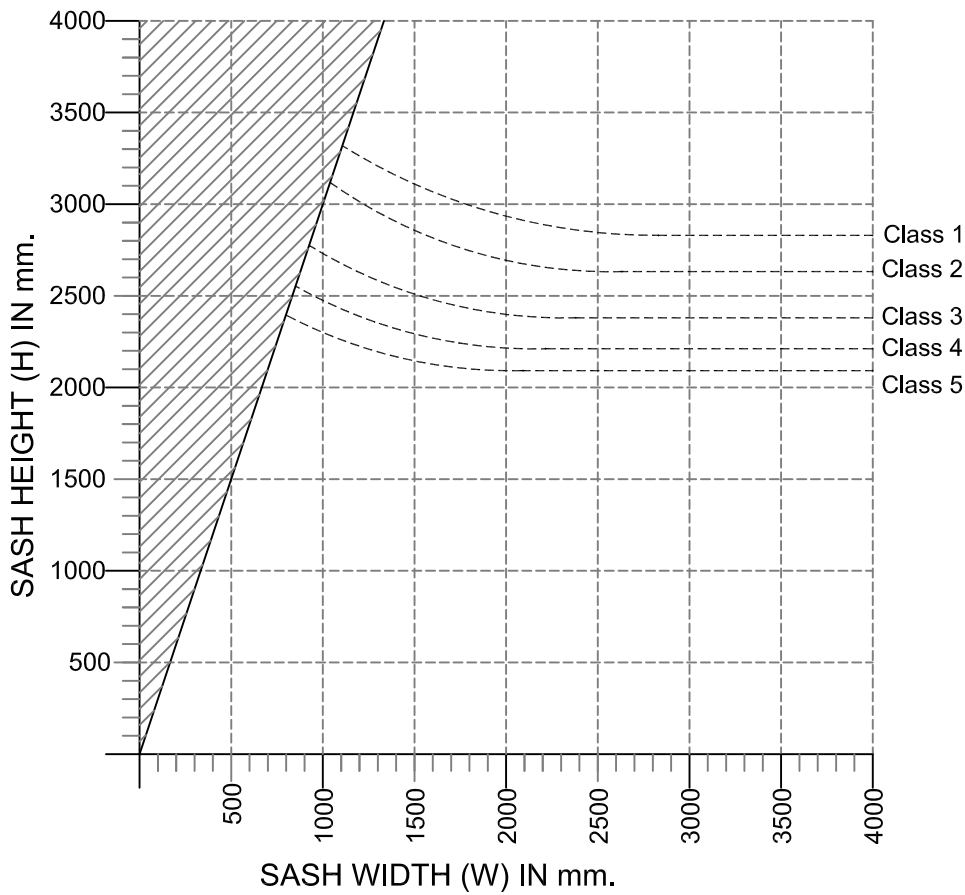
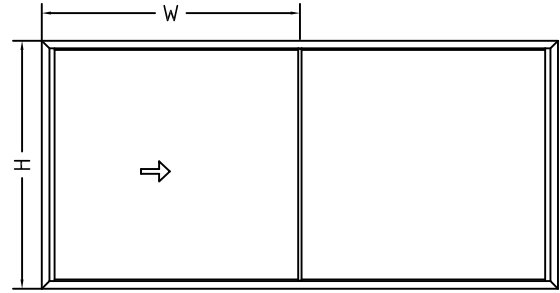

$$J_x = 45.835 + 45.835 = 91.67 \text{ cm}^4$$

- Class 1, 0.6 kN/m, 600 Pa/m²
- Class 2, 0.8 kN/m², 800 Pa/m²
- Class 3, 1.2 kN/m², 1200 Pa/m²
- Class 4, 1.6 kN/m², 1600 Pa/m²
- Class 5, 2.0 kN/m², 2000 Pa/m²

NOTES:

Max. Deflection = 15mm. in accordance with EN14351-1

Max. Sash weight in manual opening = 400 kg

Max. Sash weight in motorized opening = 700 kg

Not recommended dimension

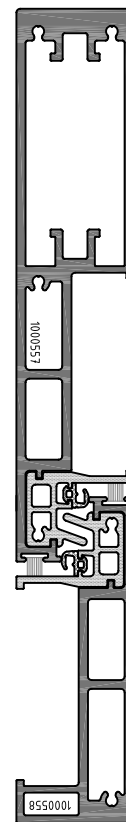
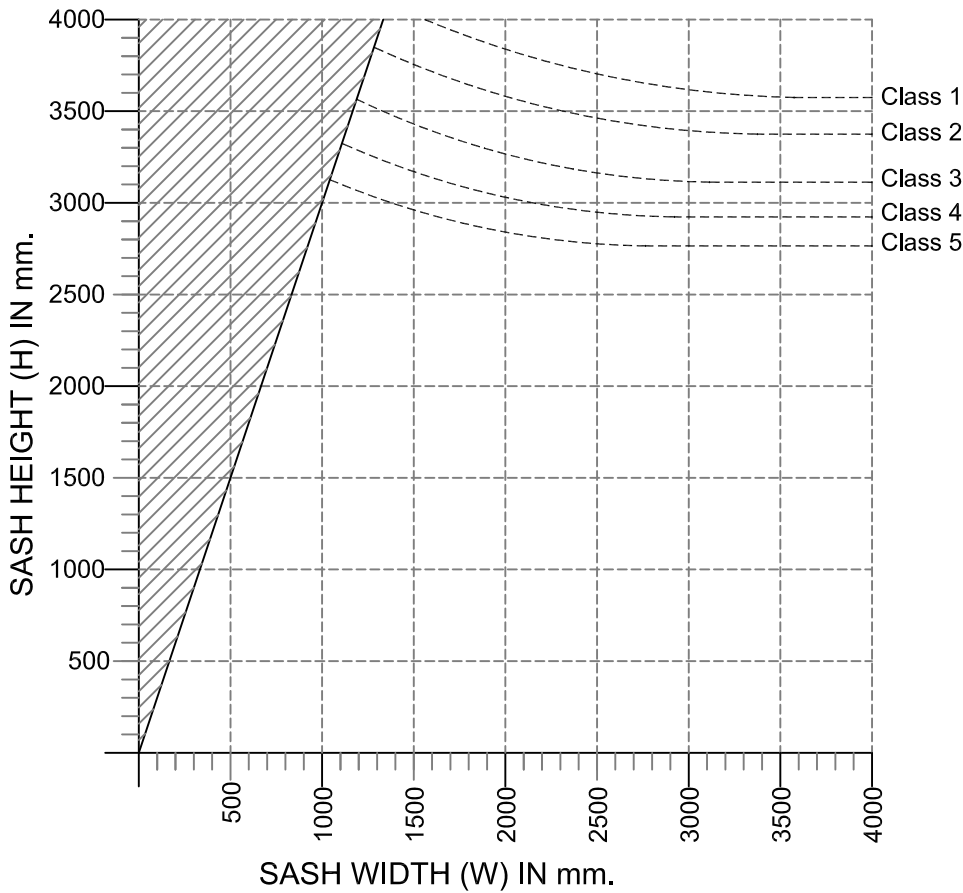
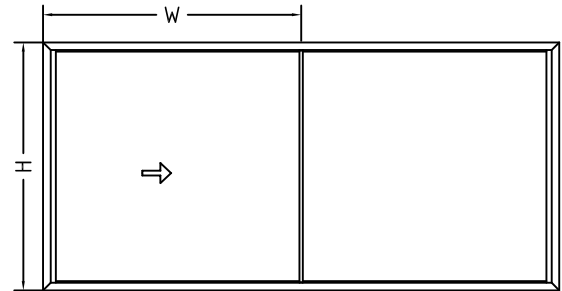

$$J_x = 45.835 + 232.825 = 278.66\text{cm}^4$$

- Class 1, 0.6 kN/m, 600 Pa/m²
- Class 2, 0.8 kN/m², 800 Pa/m²
- Class 3, 1.2 kN/m², 1200 Pa/m²
- Class 4, 1.6 kN/m², 1600 Pa/m²
- Class 5, 2.0 kN/m², 2000 Pa/m²

NOTES:

Max. Deflection = 15mm. in accordance with EN14351-1

Max. Sash weight in manual opening = 400 kg

Max. Sash weight in motorized opening = 700 kg

 Not recommended dimension

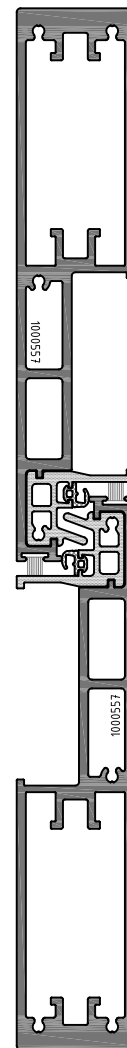
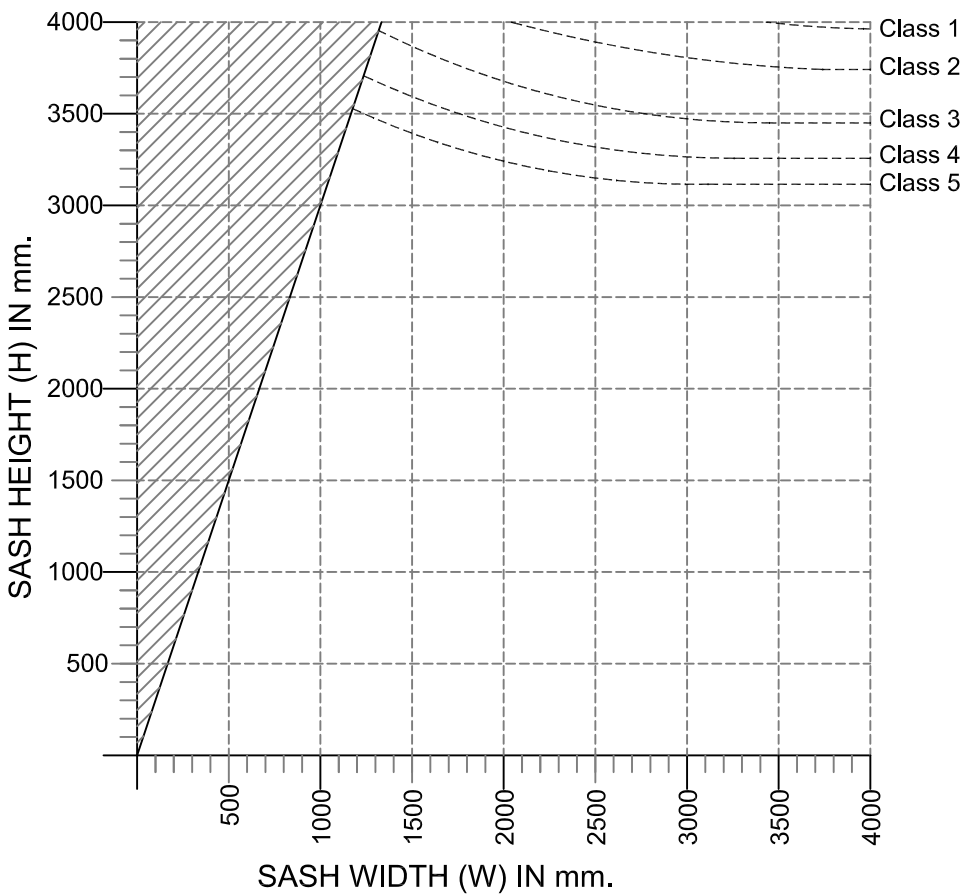
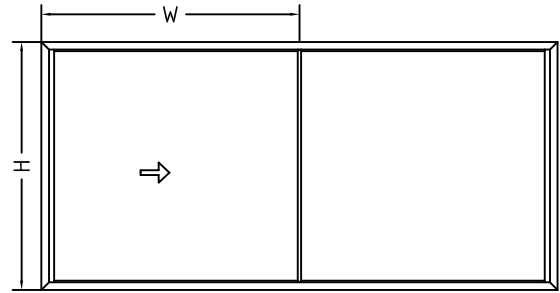

- Class 1, 0.6 kN/m, 600 Pa/m²
- Class 2, 0.8 kN/m², 800 Pa/m²
- Class 3, 1.2 kN/m², 1200 Pa/m²
- Class 4, 1.6 kN/m², 1600 Pa/m²
- Class 5, 2.0 kN/m², 2000 Pa/m²

$$J_x = 232.825 + 232.825 = 465.65 \text{ cm}^4$$

NOTES:

- Max. Deflection = 15mm. in accordance with EN14351-1
- Max. Sash weight in manual opening = 400 kg
- Max. Sash weight in motorized opening = 700 kg

Not recommended dimension

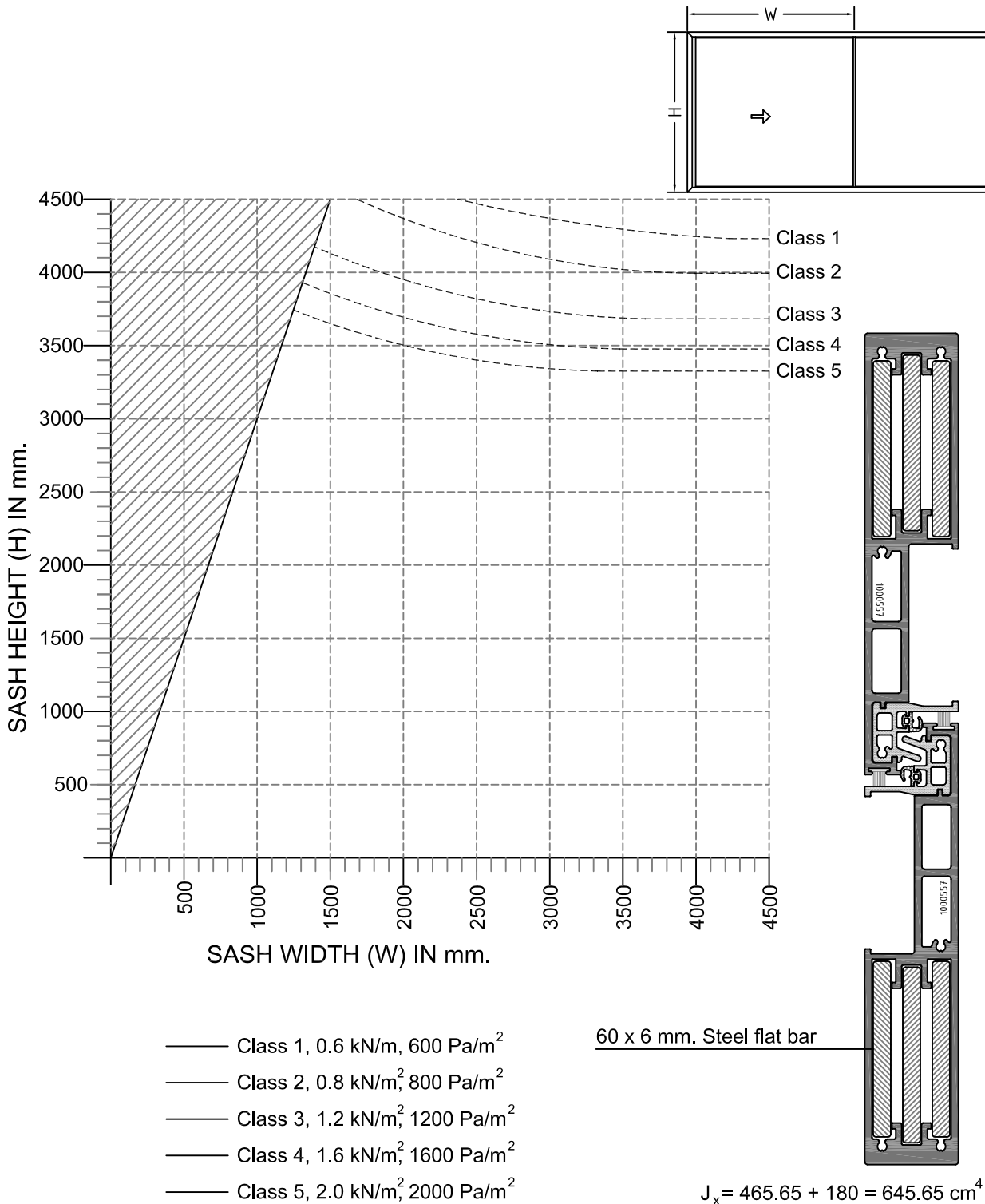

NOTES:

Max. Deflection = 15mm. in accordance with EN14351-1

Max. Sash weight in manual opening = 400 kg

Max. Sash weight in motorized opening = 700 kg

 Not recommended dimension

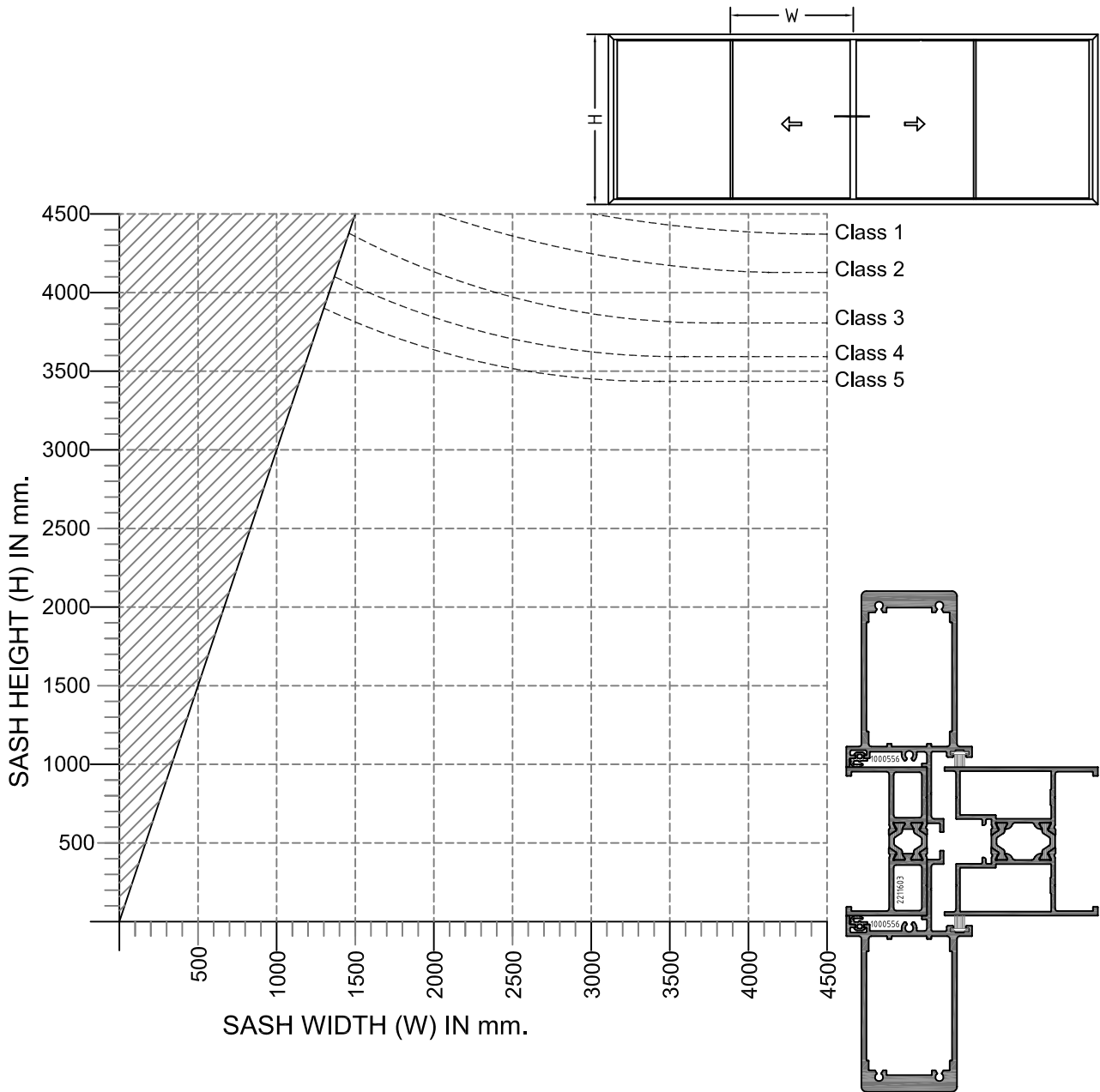

- Class 1, 0.6 kN/m, 600 Pa/m²
- Class 2, 0.8 kN/m², 800 Pa/m²
- Class 3, 1.2 kN/m², 1200 Pa/m²
- Class 4, 1.6 kN/m², 1600 Pa/m²
- Class 5, 2.0 kN/m², 2000 Pa/m²













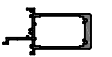

$$J_x = 746.9 + 14.1 = 761 \text{ cm}^4$$

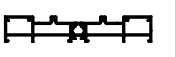
NOTES:

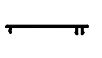
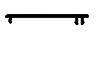
- Max. Deflection = 15mm. in accordance with EN14351-1
- Max. Sash weight in manual opening = 400 kg
- Max. Sash weight in motorized opening = 700 kg

Not recommended dimension

PROFILES :

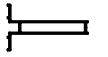
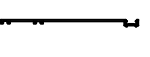
Number	Shape	DESCRIPTION	$I_x \text{ cm}^4$	$I_y \text{ cm}^4$
2111601		Frame Profile	325.21	54.42
2211601		Manual Sliding Sash/Jamb	22.87	14.14
2211602		Top/Bottom Rail Sash	18.07	2.60
2211603		Motorized Sliding Sash/Jamb	16.11	2.75
1000556		Meeting Profile	14.26	58.17
1000557		Reinforced Interlock Sash	11.46	232.82
1000558		Interlock Sash	3.39	45.83
2611601		Drain Collector	---	---
2611602		Motorized Frame / Top	---	---
1000546		Roller Support	---	---
1000547		Frame Cover Top/Side	---	---
1000548		Frame Cover Bottom	---	---
1000552		V Shape Rail	---	---
1000553		Striker Support Profile	---	---
1000549		Gutter Cover	---	---
1000550		Drainage Gutter	---	---
1000569		Motorized Frame Coupling	---	---
1000570		Motorized Frame Separator	---	---
1000572		Motorized Frame Side Cover	---	---

ACCESSORIES :

Number	Shape	DESCRIPTION
7001002		Glazing Gasket
7001005		Glazing Gasket
7001034		Glazing Gasket
7001062		Glazing Gasket
7001040		Stop Gasket
7906807		Weather Pile
7001029		Cover Gasket
7001073		Cover Gasket
7001028		Cover Gasket
7501026		Interlock Thermal Separator

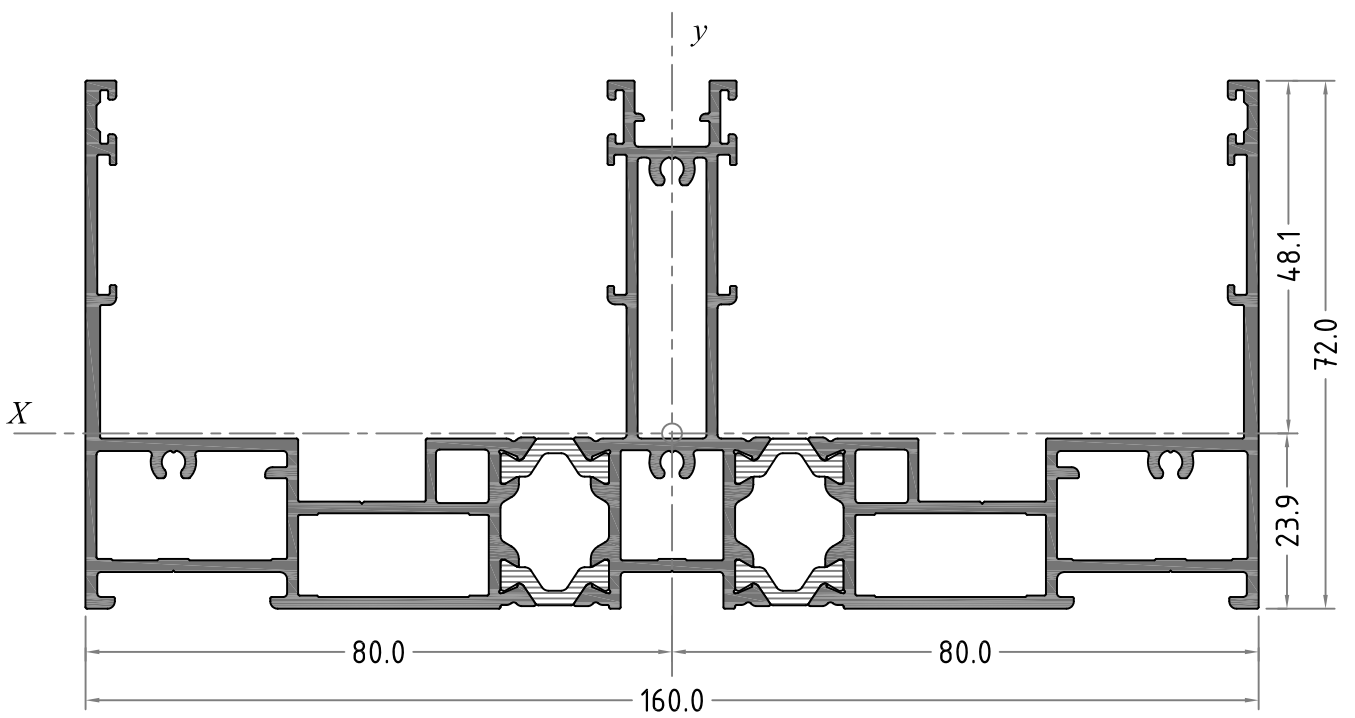

DESCRIPTION	Number	I_x cm ⁴	I_y cm ⁴	e_x cm	e_y cm	W_x cm ³	W_y cm ³
Frame Profile	2111601	325.21	54.42	8.00	2.39	67.61	6.80

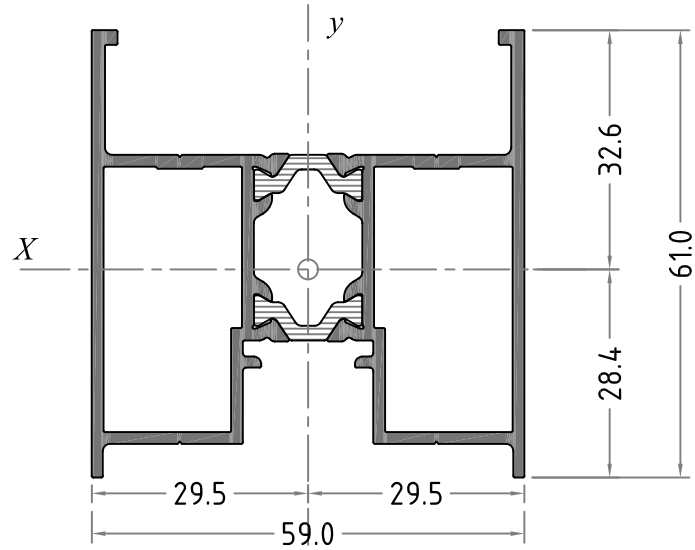

DESCRIPTION	Number	I_x cm ⁴	I_y cm ⁴	e_x cm	e_y cm	W_x cm ³	W_y cm ³
Manual Sliding Sash/Jamb	2211601	22.87	14.14	2.95	2.835	7.03	4.79

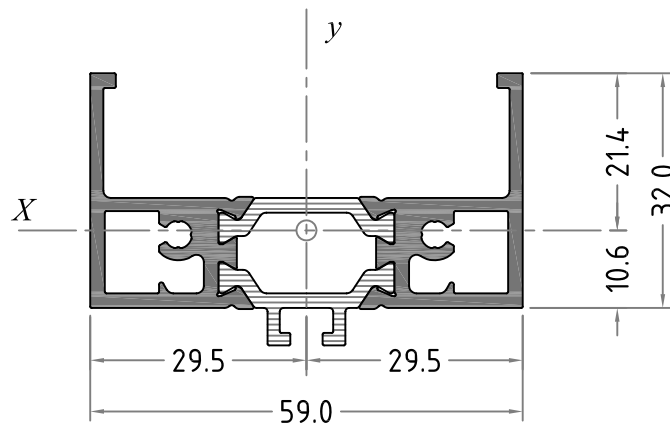

DESCRIPTION	Number	I_x cm ⁴	I_y cm ⁴	e_x cm	e_y cm	W_x cm ³	W_y cm ³
Top/Bottom Rail Sash	2211602	18.07	2.60	2.95	1.06	8.43	0.883

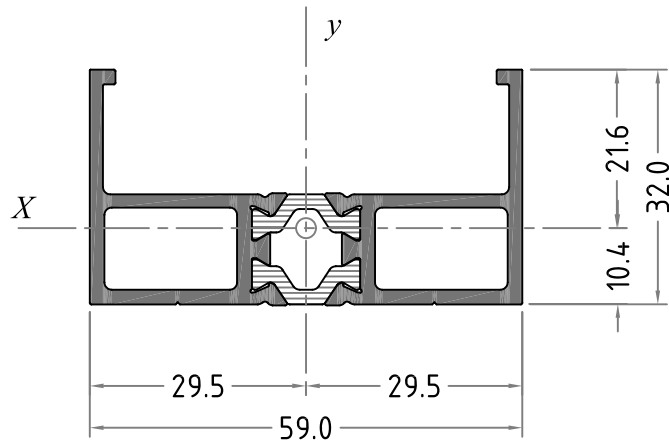

DESCRIPTION	Number	I_x cm ⁴	I_y cm ⁴	e_x cm	e_y cm	W_x cm ³	W_y cm ³
Motorized Sliding Sash/Jamb	2211603	16.11	2.75	2.95	1.039	7.45	0.932

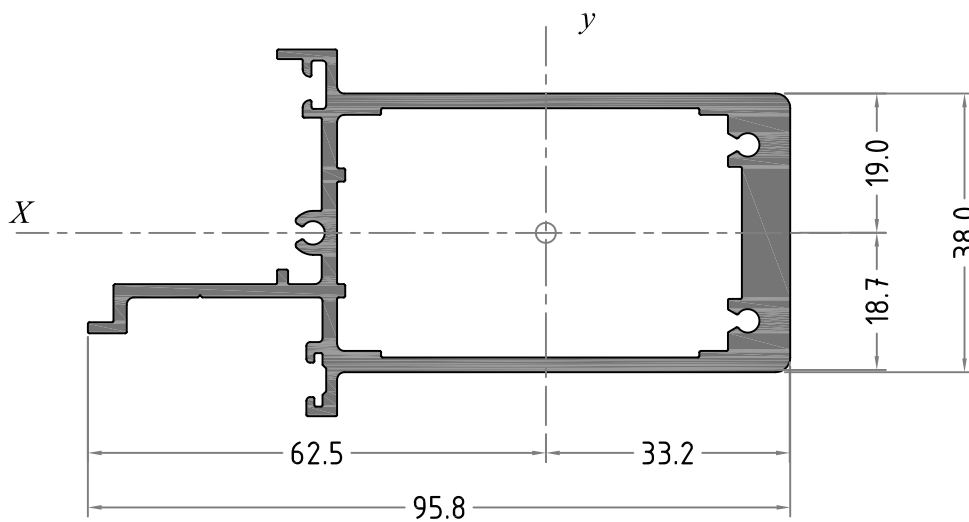

DESCRIPTION	Number	I_x cm ⁴	I_y cm ⁴	e_x cm	e_y cm	W_x cm ³	W_y cm ³
Meeting Profile	1000556	14.26	58.17	6.24	2.43	4.28	22.67

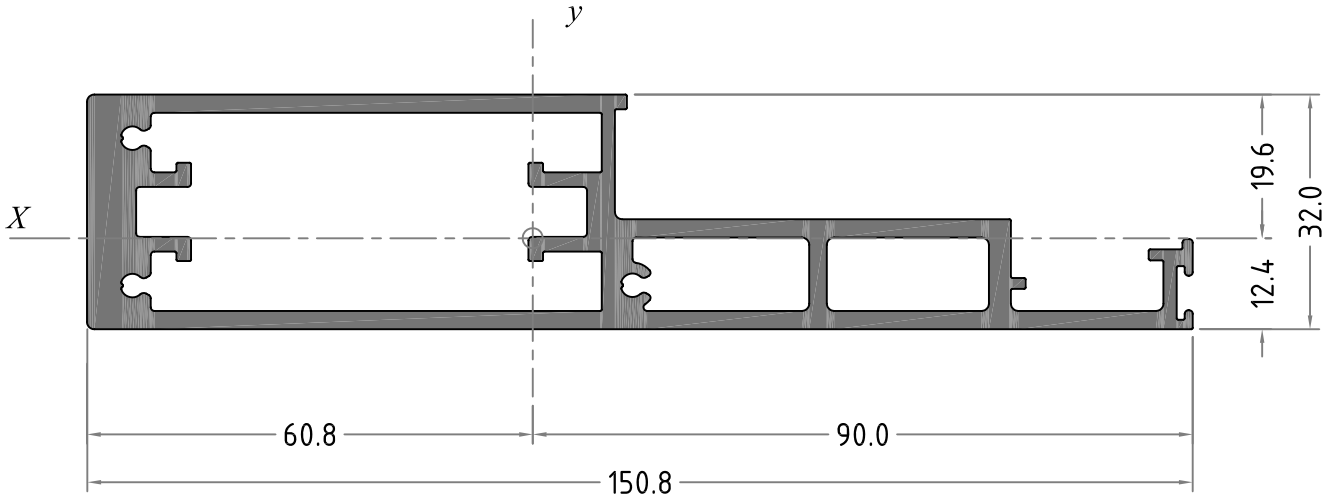

DESCRIPTION	Number	$I_x \text{ cm}^4$	$I_y \text{ cm}^4$	$e_x \text{ cm}$	$e_y \text{ cm}$	$W_x \text{ cm}^3$	$W_y \text{ cm}^3$
Reinforced Interlock Profile	1000557	11.46	232.82	6.078	1.24	5.847	25.86

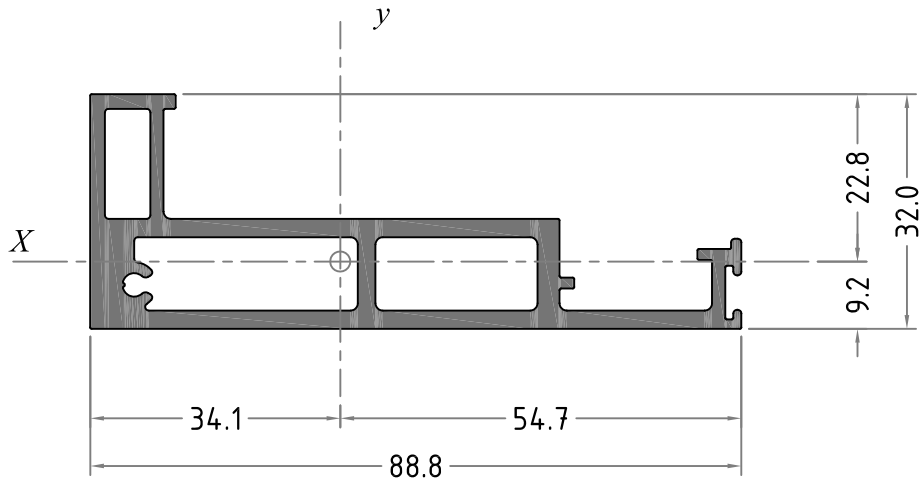

DESCRIPTION	Number	$I_x \text{ cm}^4$	$I_y \text{ cm}^4$	$e_x \text{ cm}$	$e_y \text{ cm}$	$W_x \text{ cm}^3$	$W_y \text{ cm}^3$
Interlock Profile	1000558	3.39	45.84	3.41	9.18	1.487	8.381

SERIES GS160PD

PROFILES

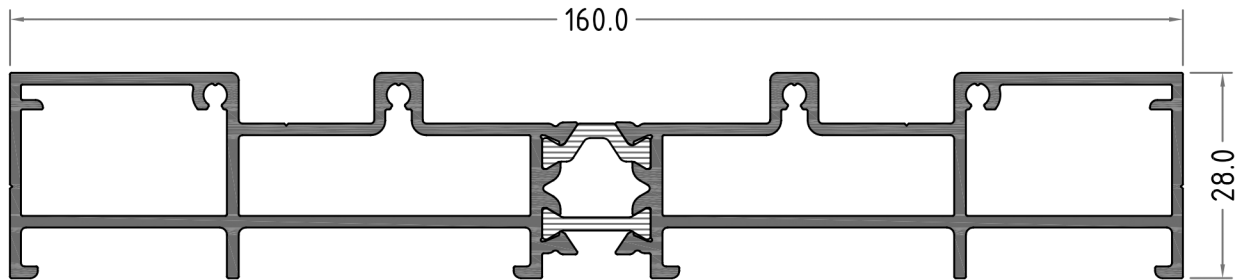

DESCRIPTION	Number
Drain Collector	2611601

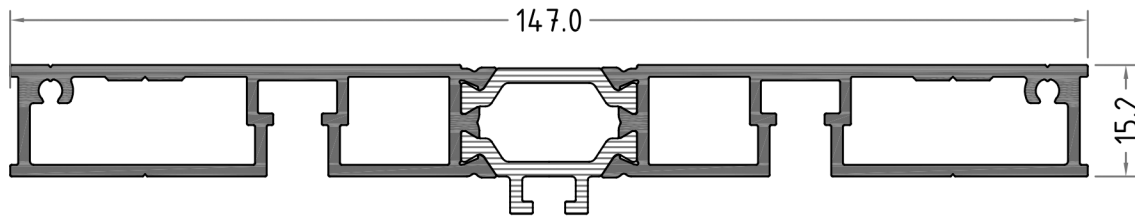

DESCRIPTION	Number
Motorized Frame / Top	2611602

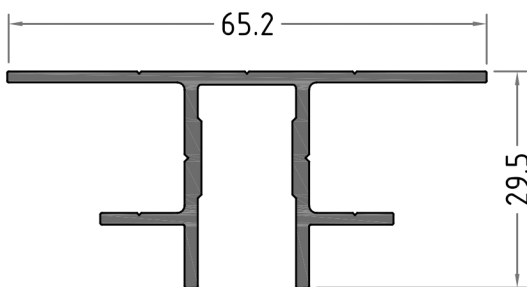

DESCRIPTION	Number
Roller Support	1000546

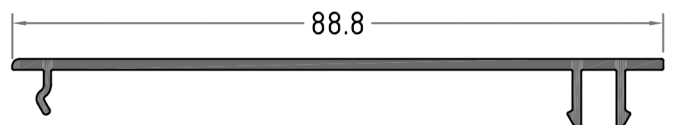

DESCRIPTION	Number
Frame Cover Top/Side	1000547

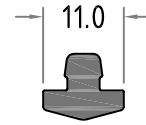
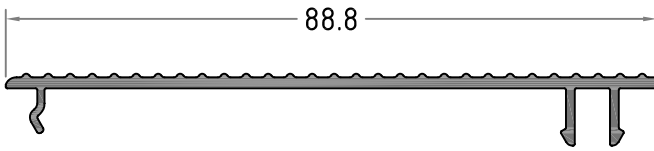

DESCRIPTION	Number
Frame Cover Bottom	1000548

DESCRIPTION	Number
V Shape Rail	1000552

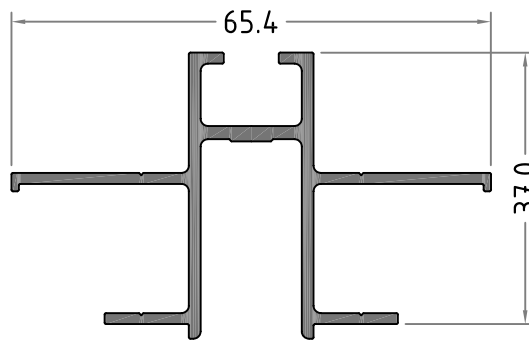

DESCRIPTION	Number
Striker Support Profile	1000553

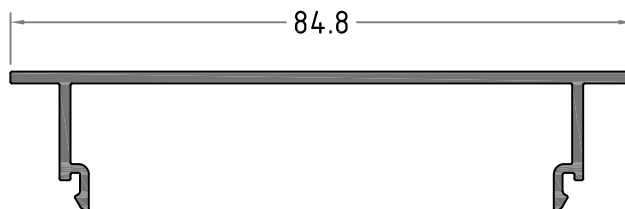

DESCRIPTION	Number
Gutter Cover	1000549

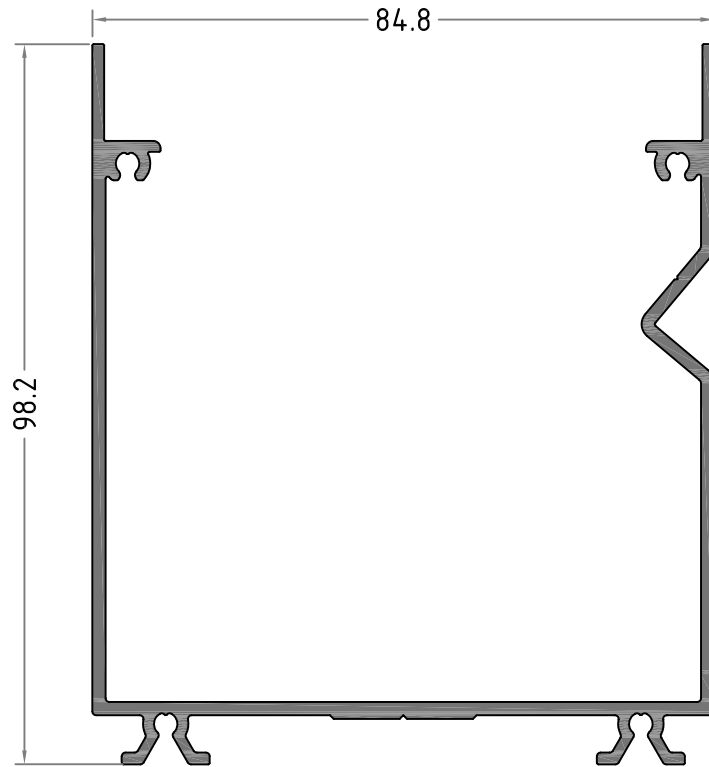

DESCRIPTION	Number
Drainage Gutter	1000550

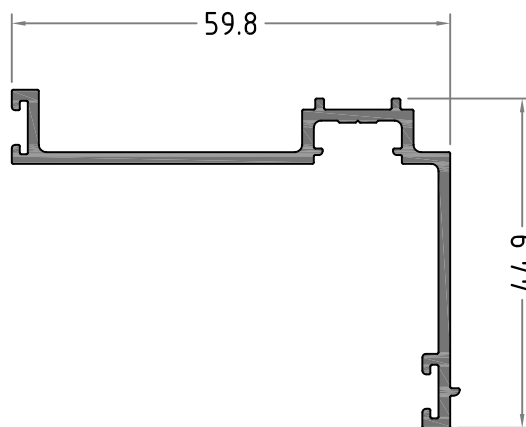

DESCRIPTION	Number
Motorized Frame Coupling	1000569

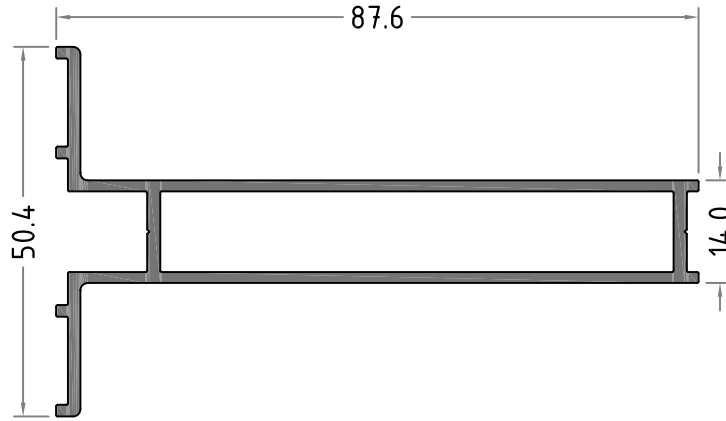

DESCRIPTION	Number
Motorized Frame Separator	1000570

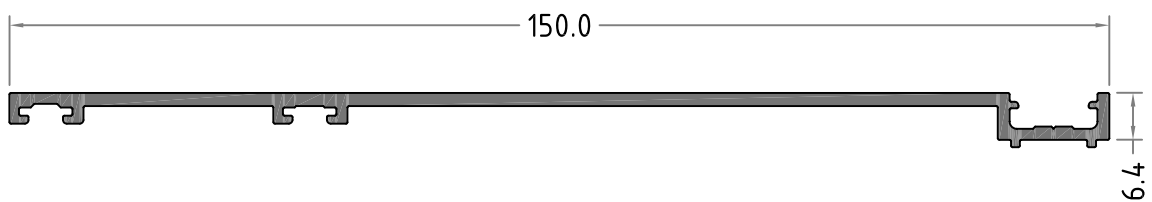

DESCRIPTION	Number
Motorized Frame Side Cover	1000572

OPENING TYPES

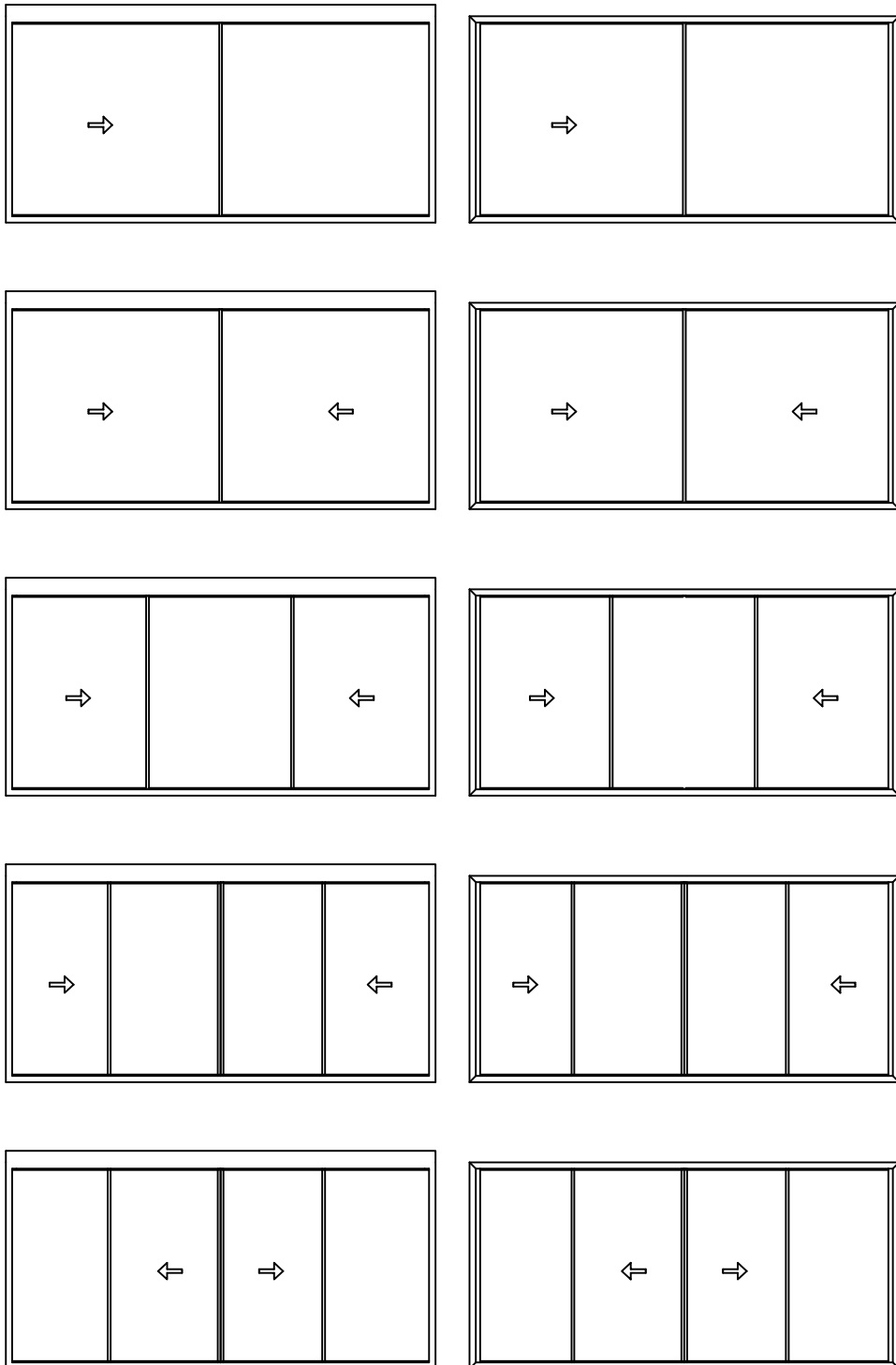

MOTORIZED OPENING

MANUAL OPENING

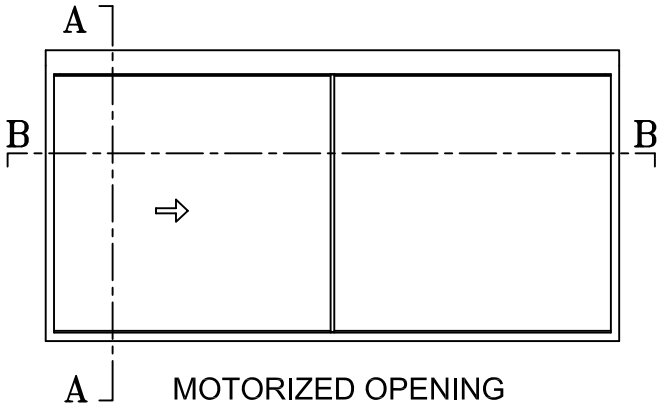

SECTION A

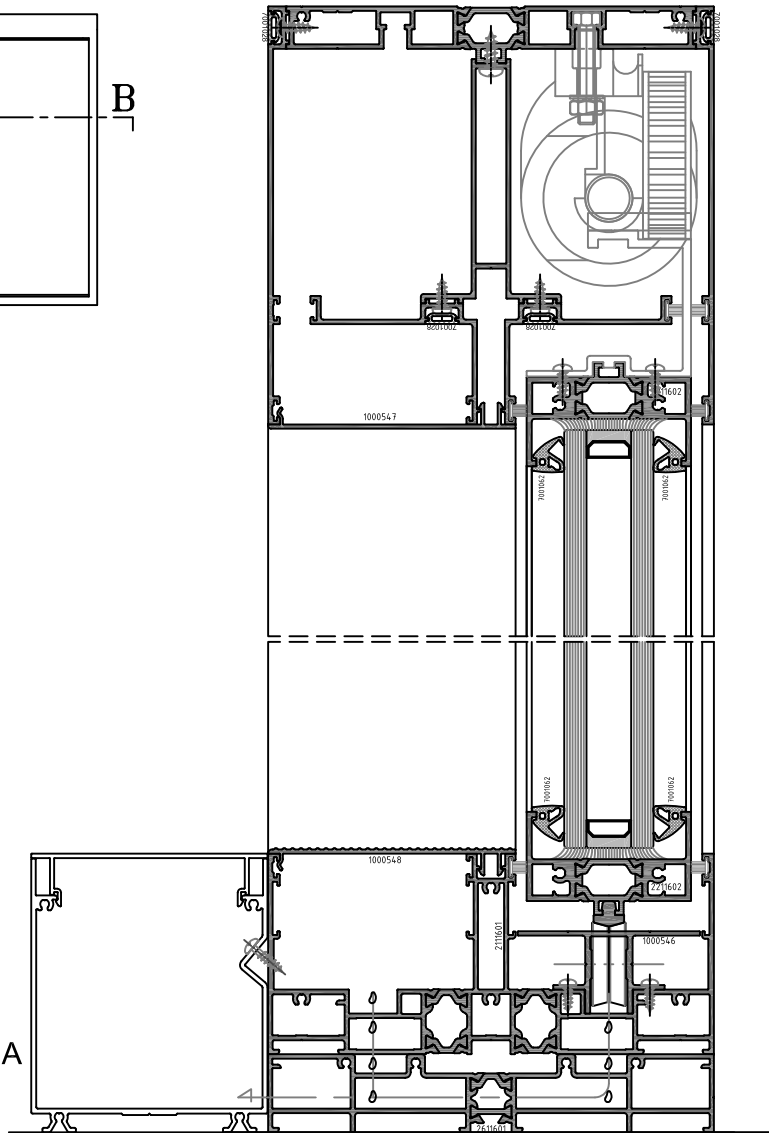

SECTION B

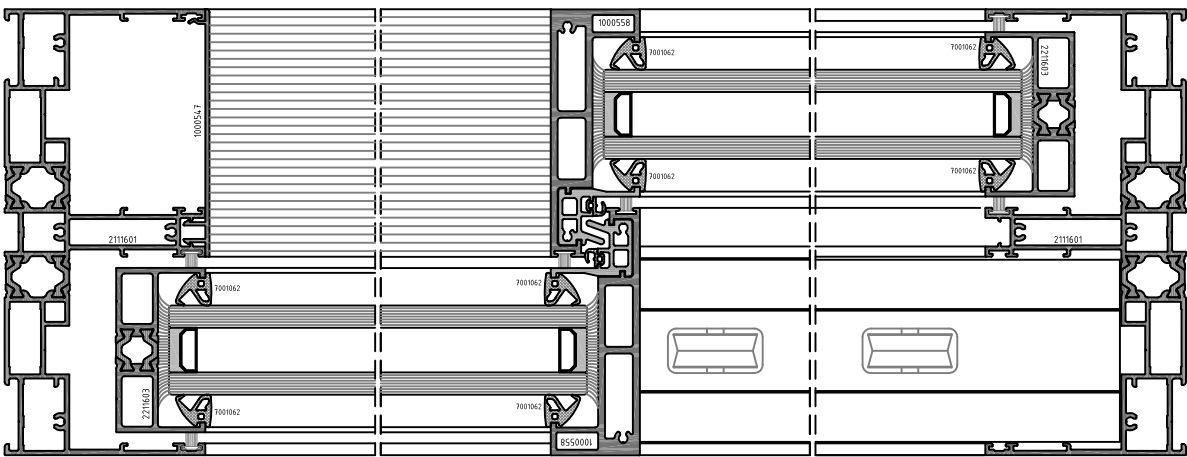

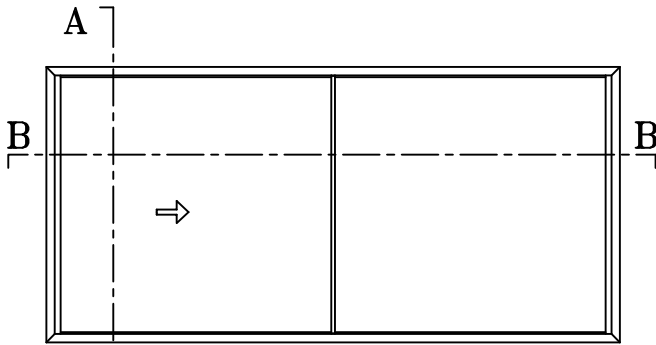

A | MANUAL OPENING

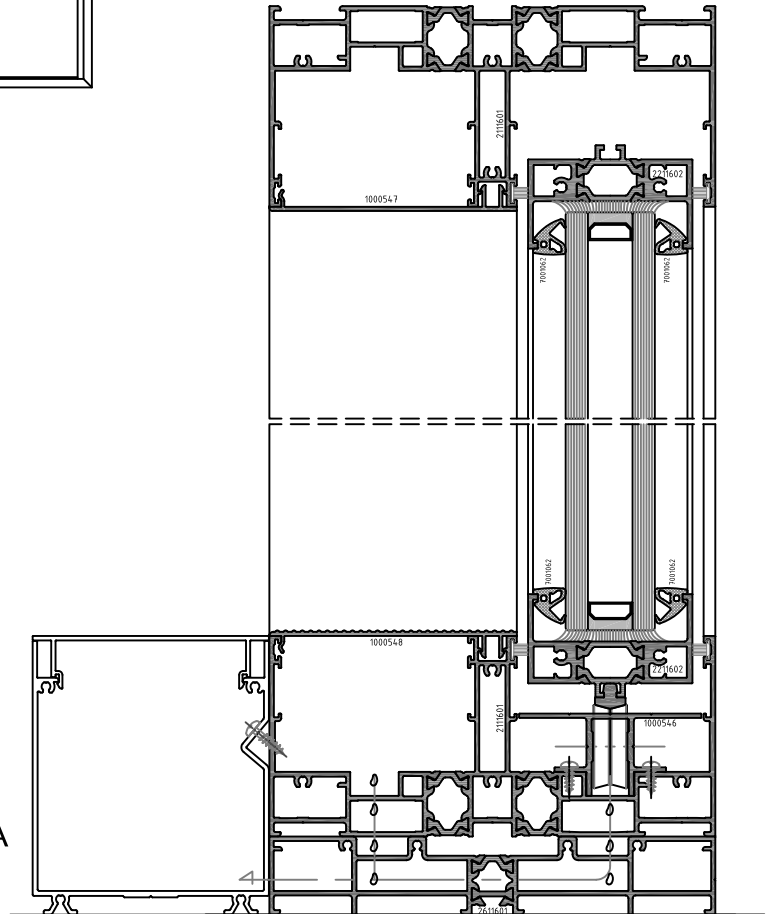

SECTION A

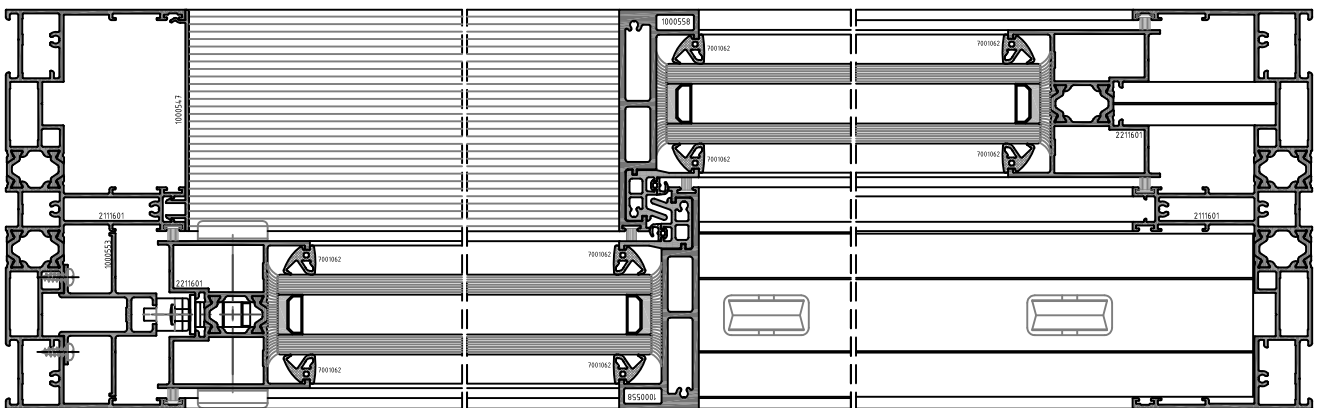

SECTION B

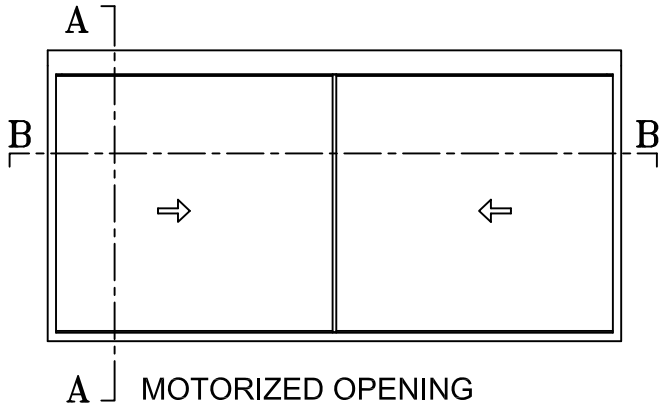

SECTION A

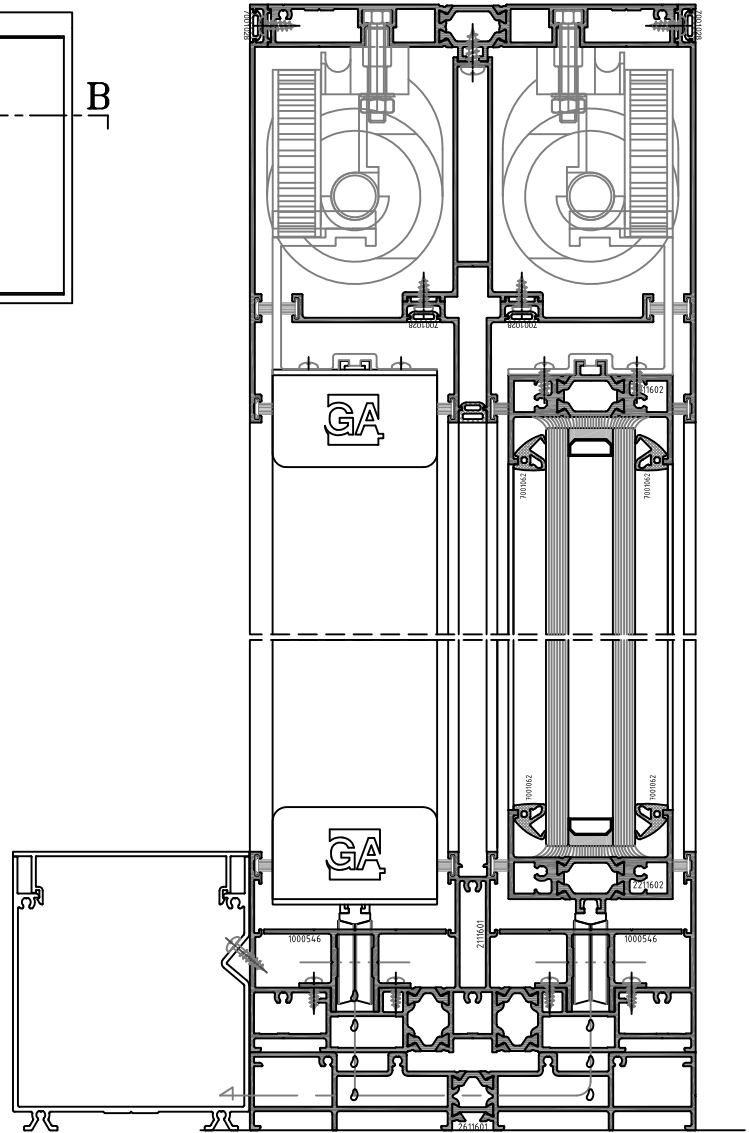

SECTION B

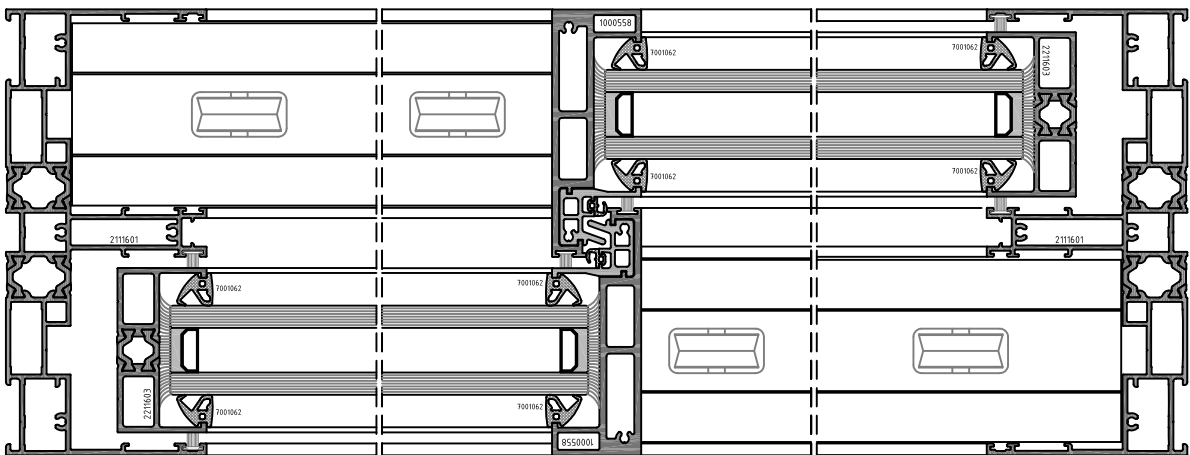

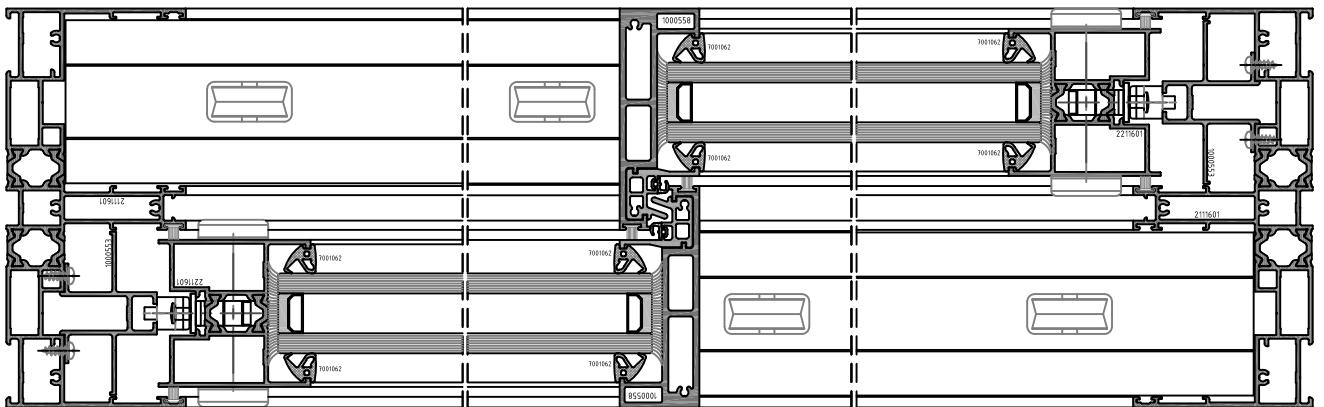
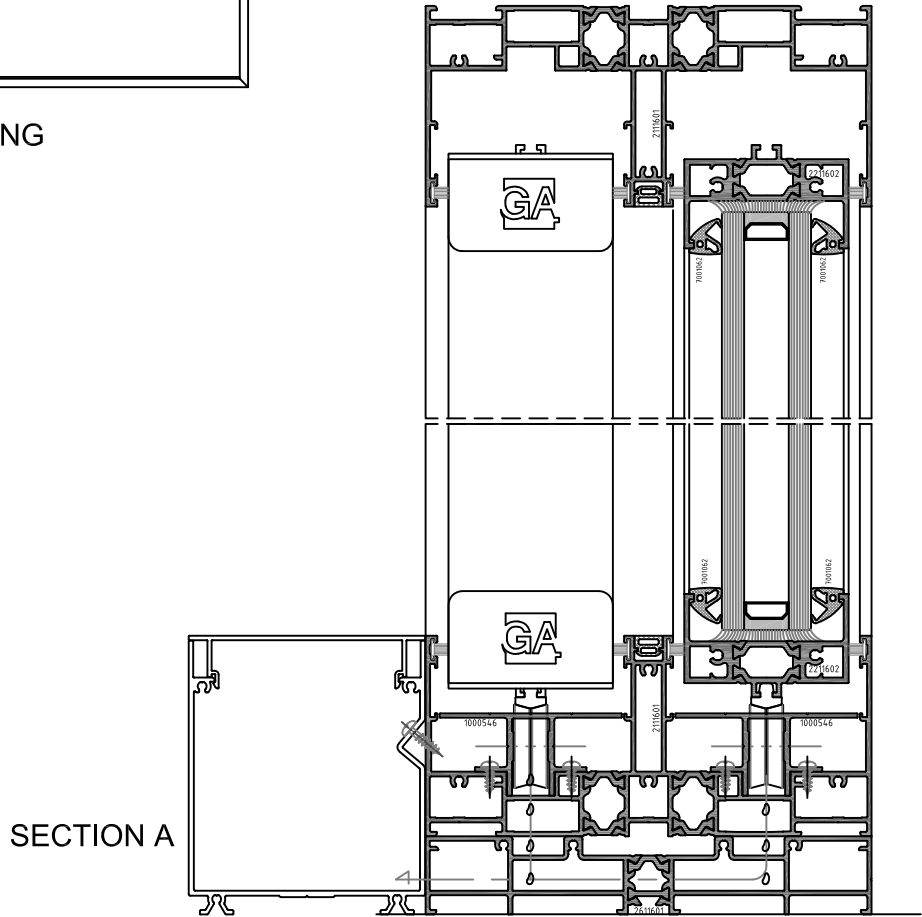
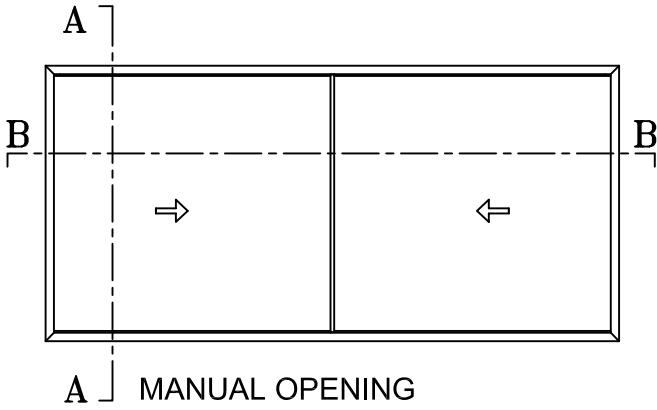

SECTION B

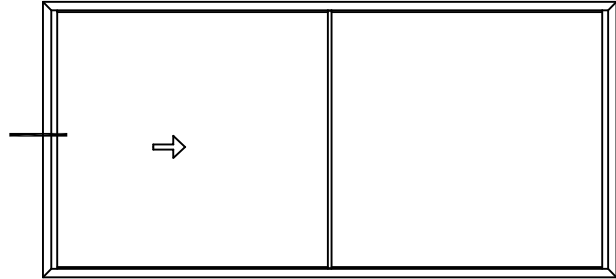

MANUAL OPENING

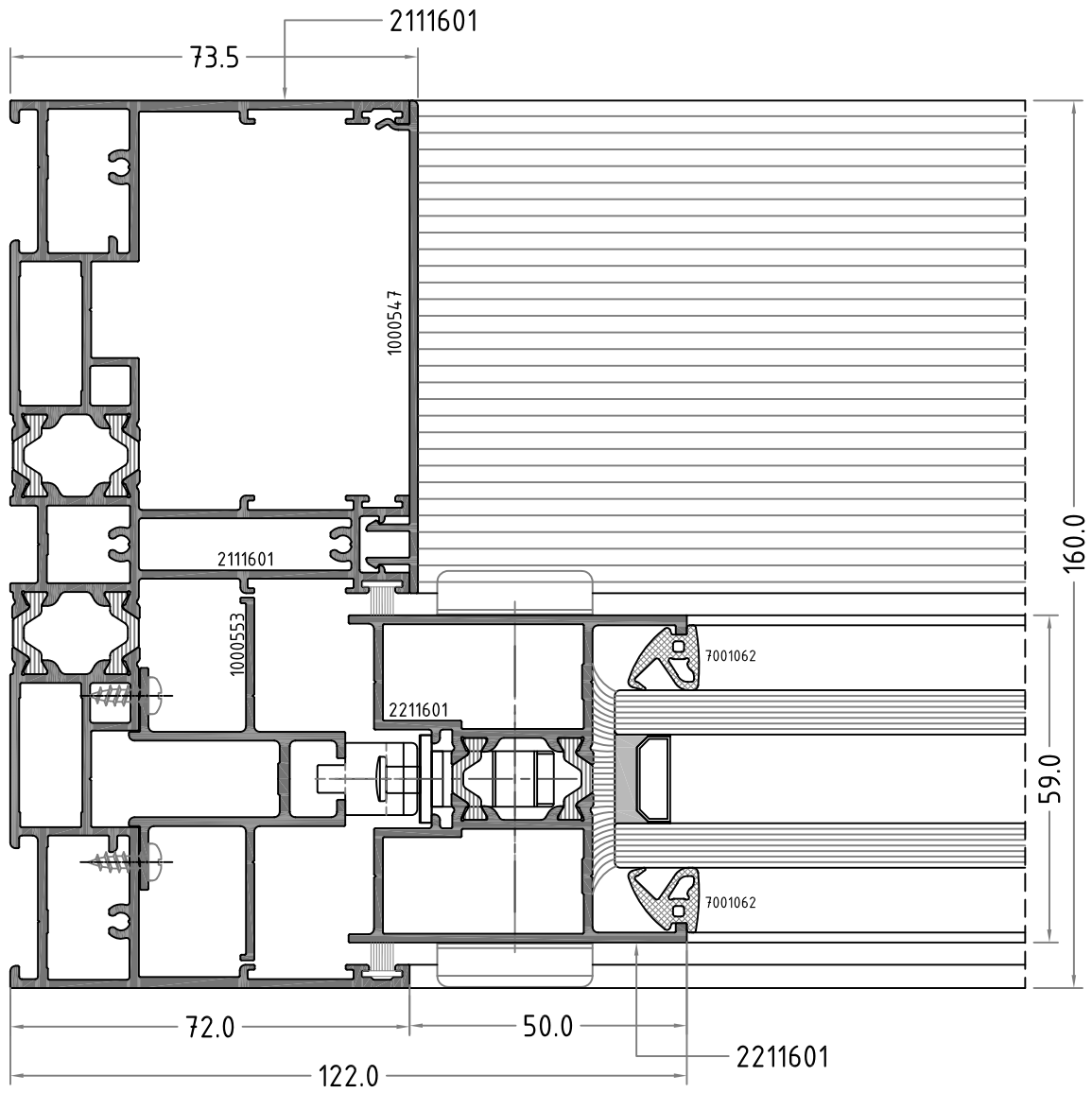

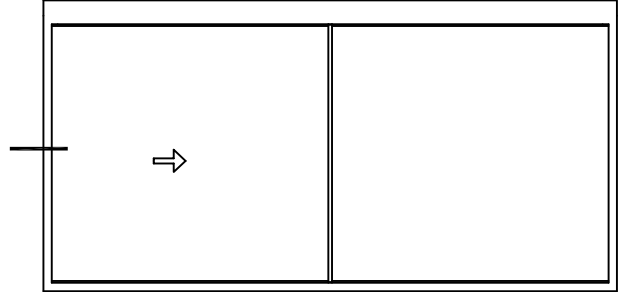

MOTORIZED OPENING

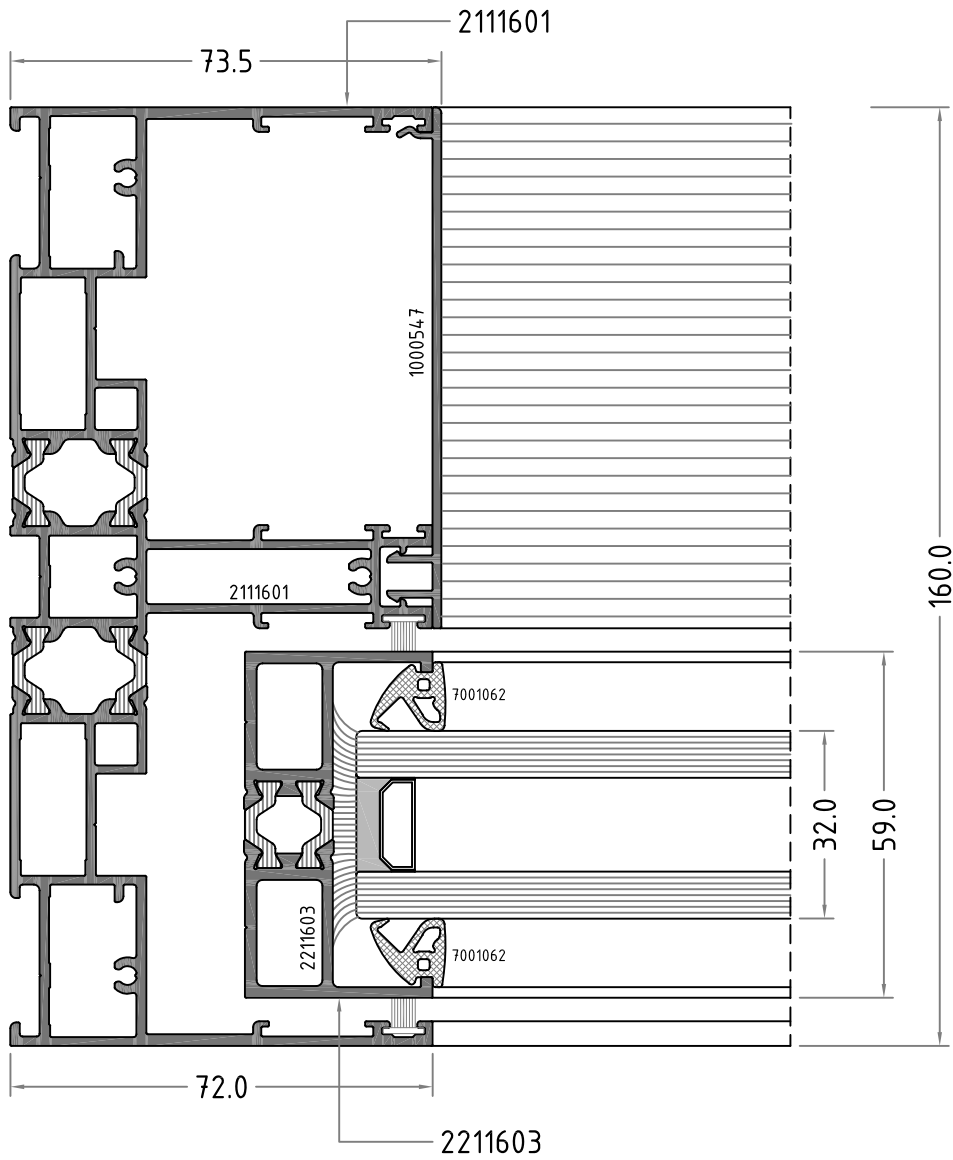

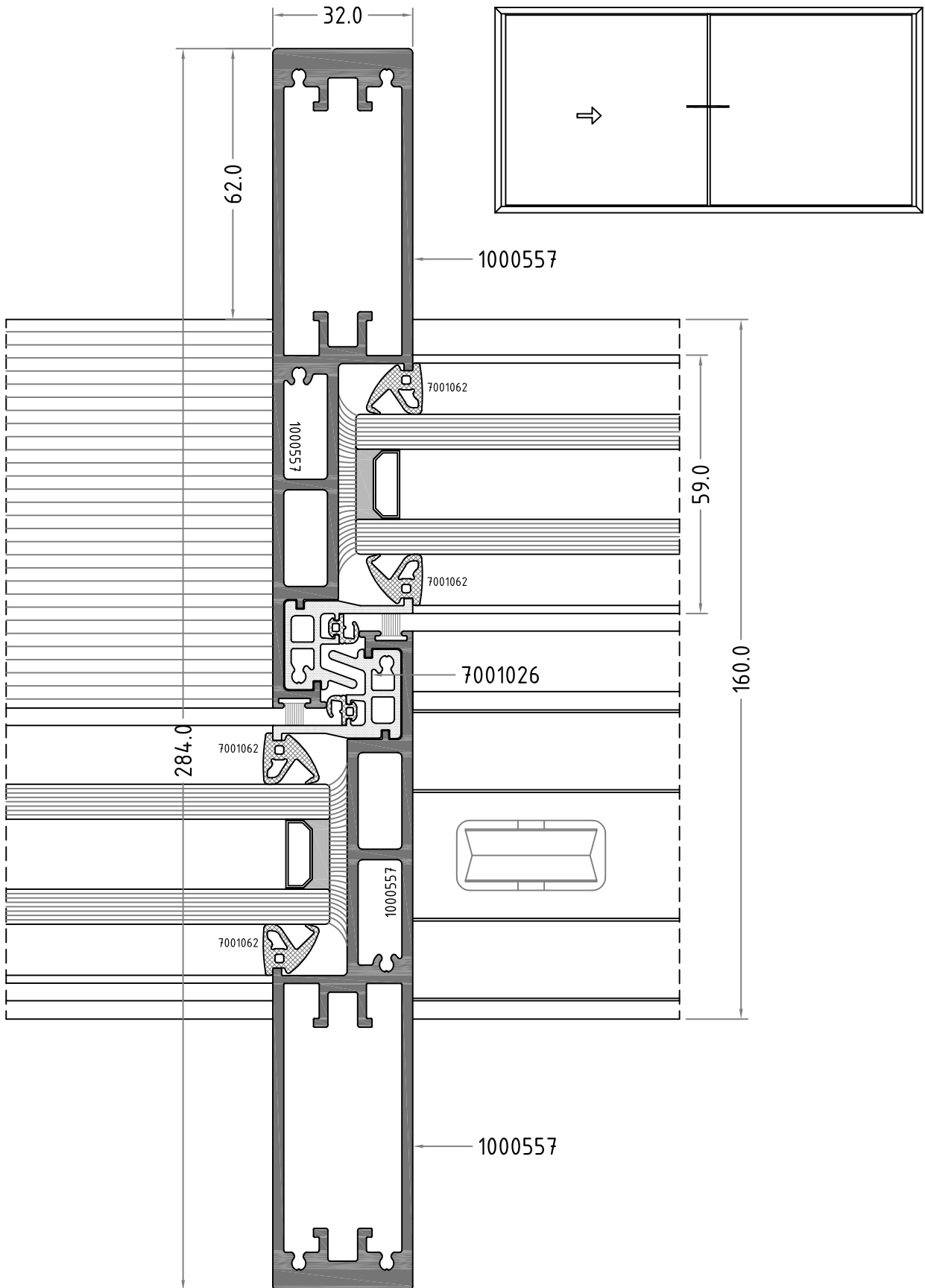

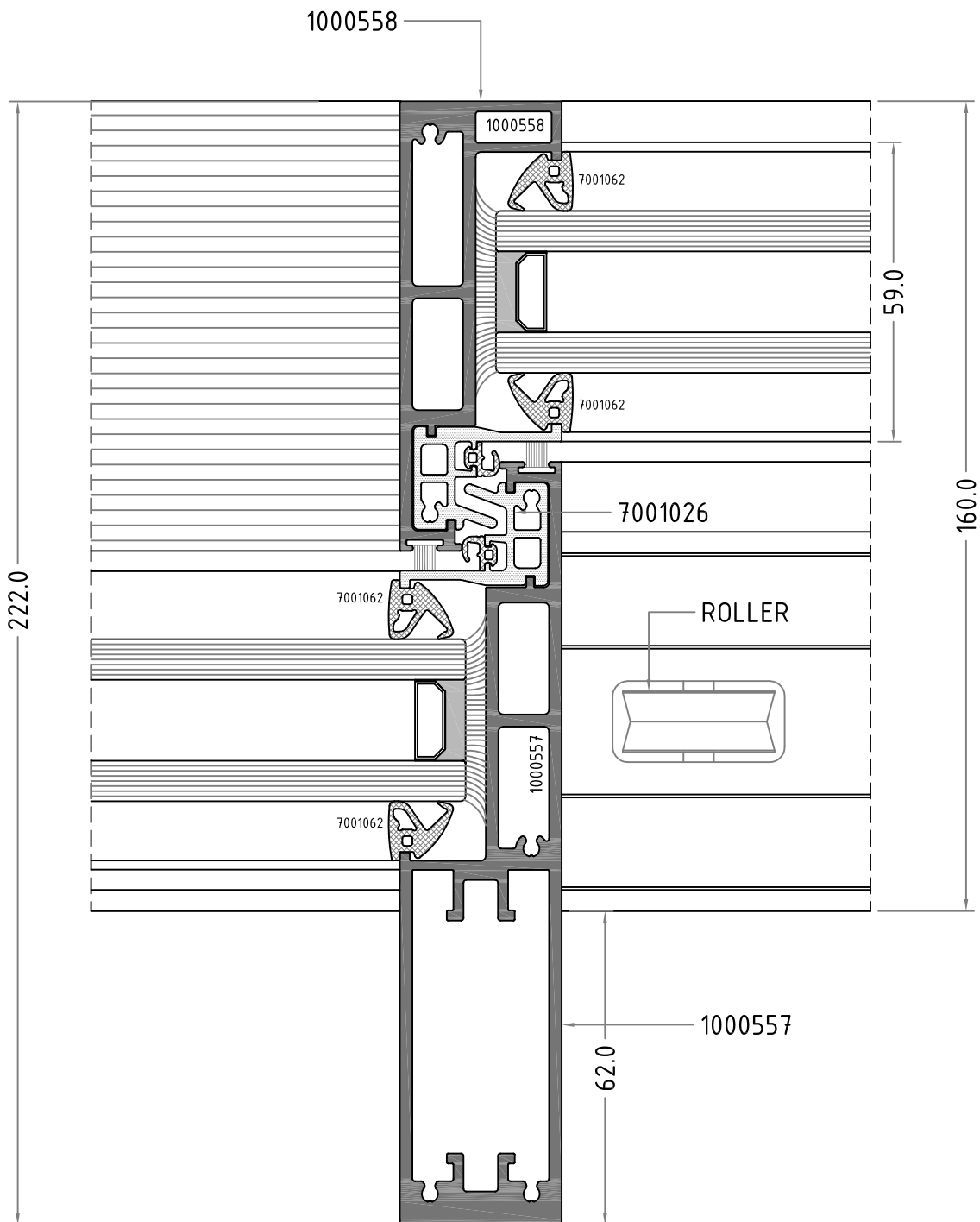
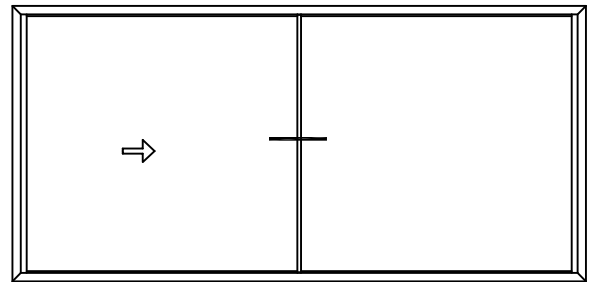

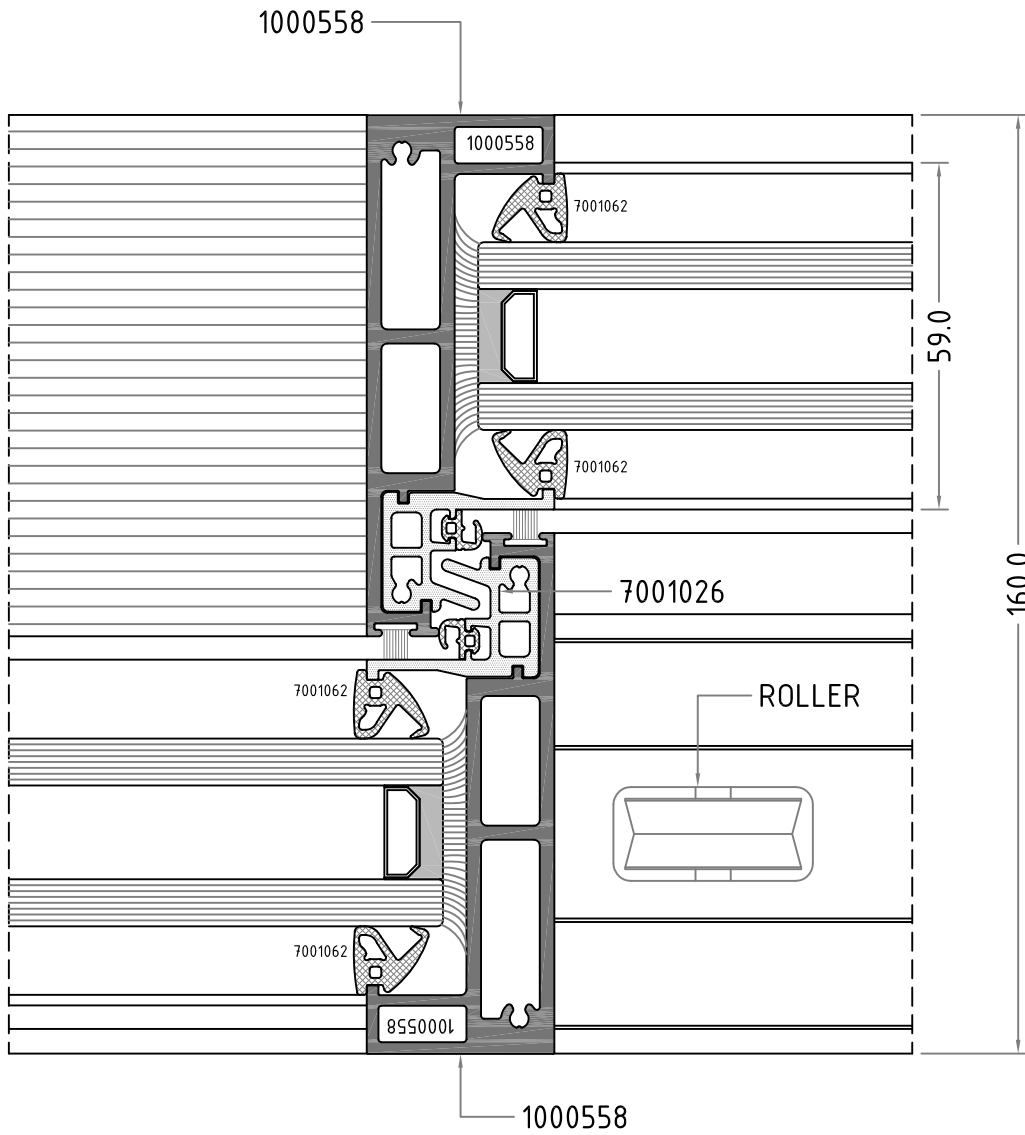
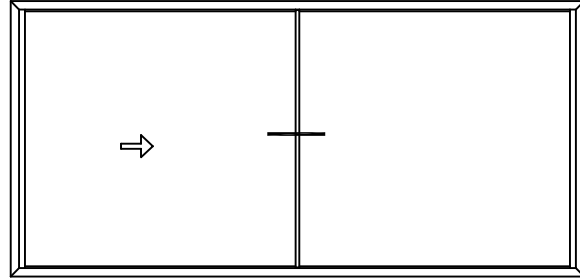

MANUAL OPENING

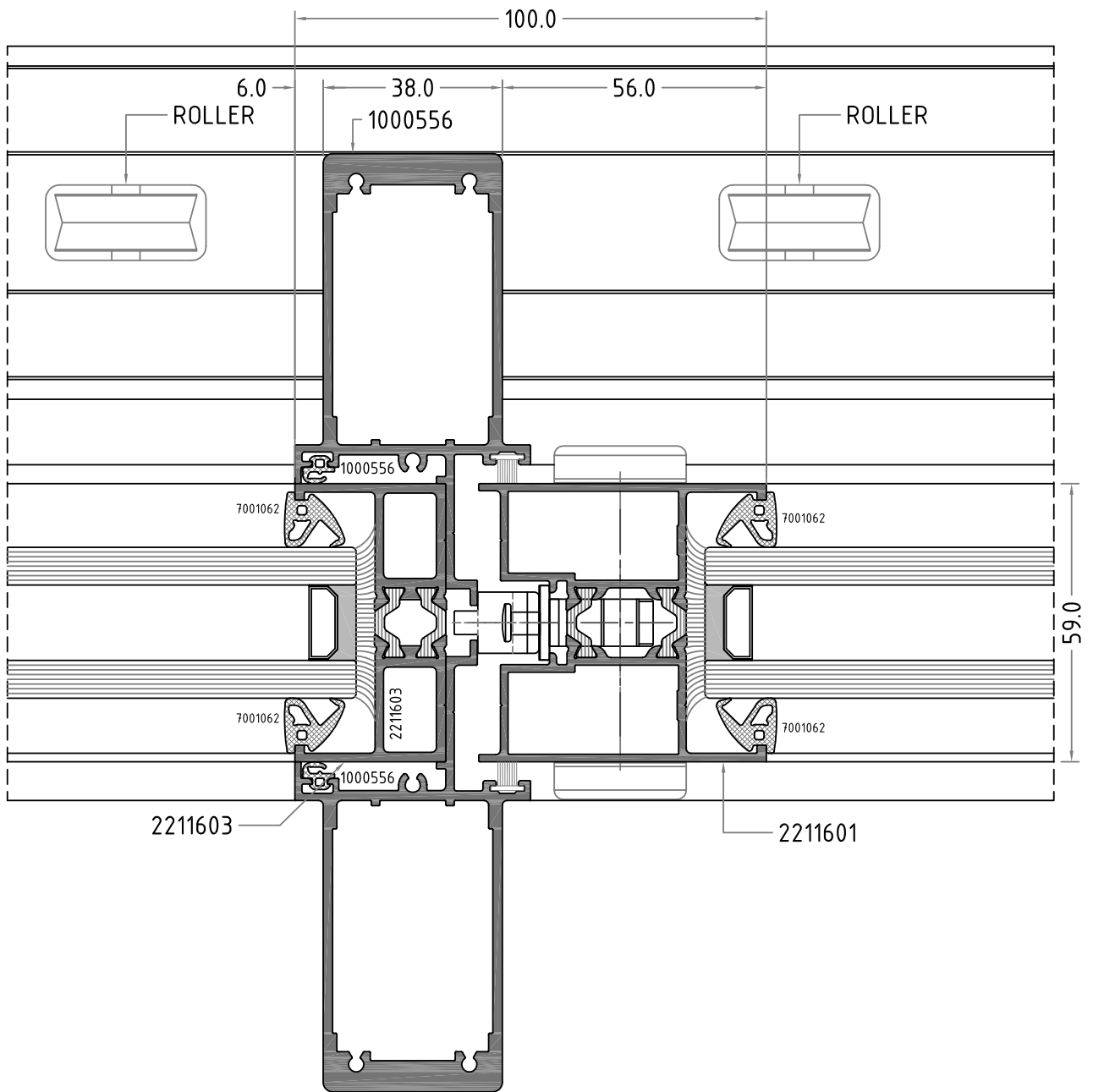
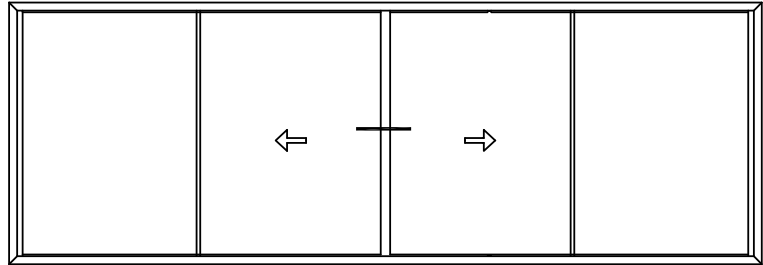

MOTORIZED OPENING

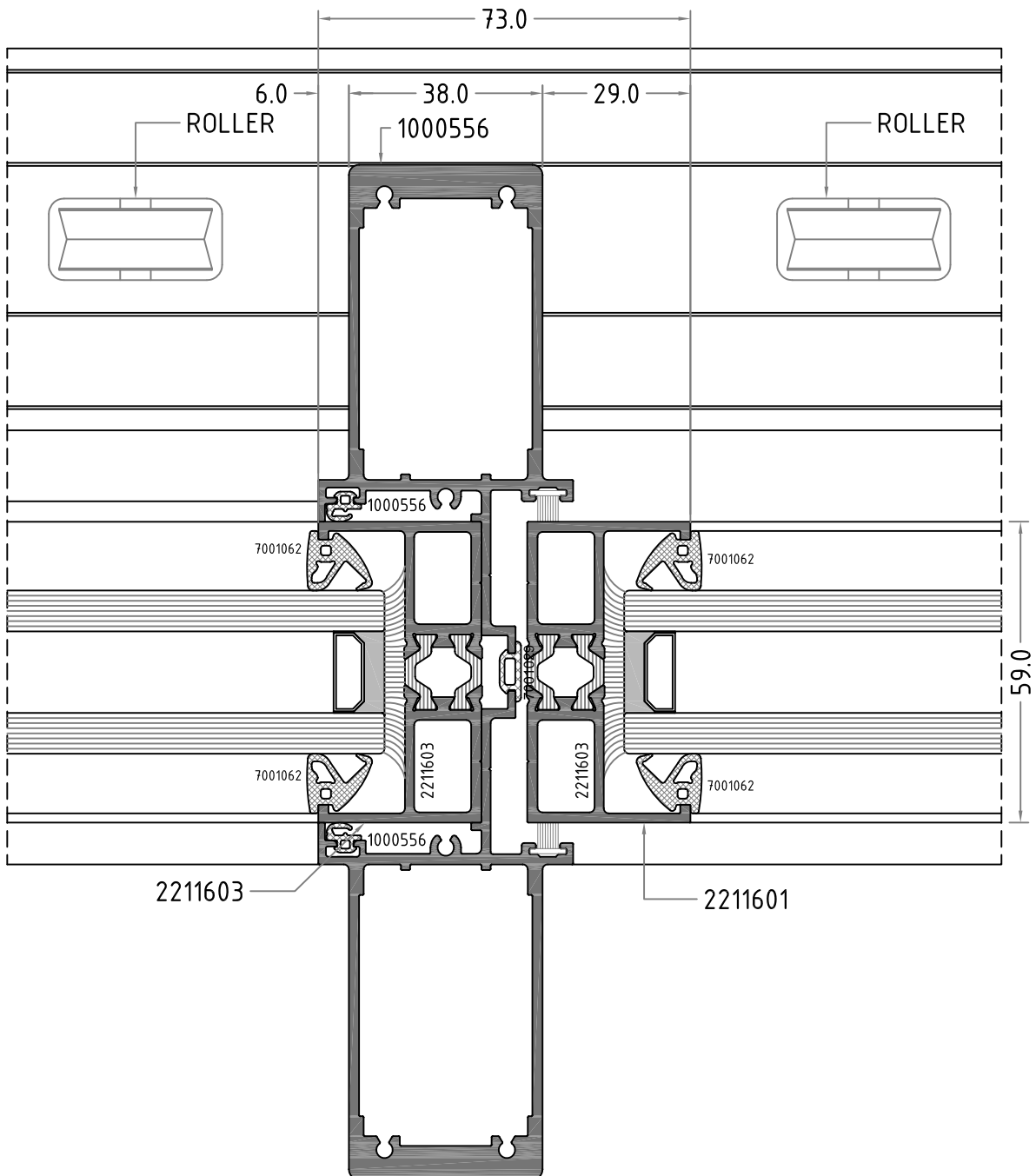
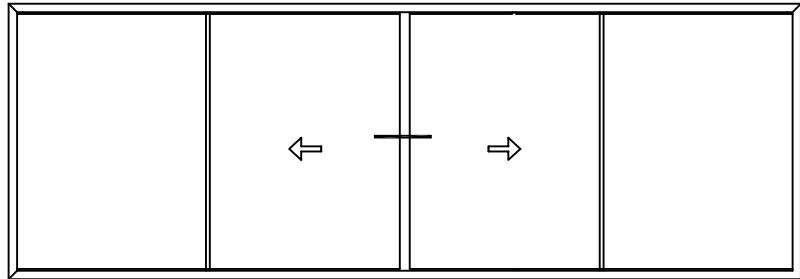

MANUAL OPENING

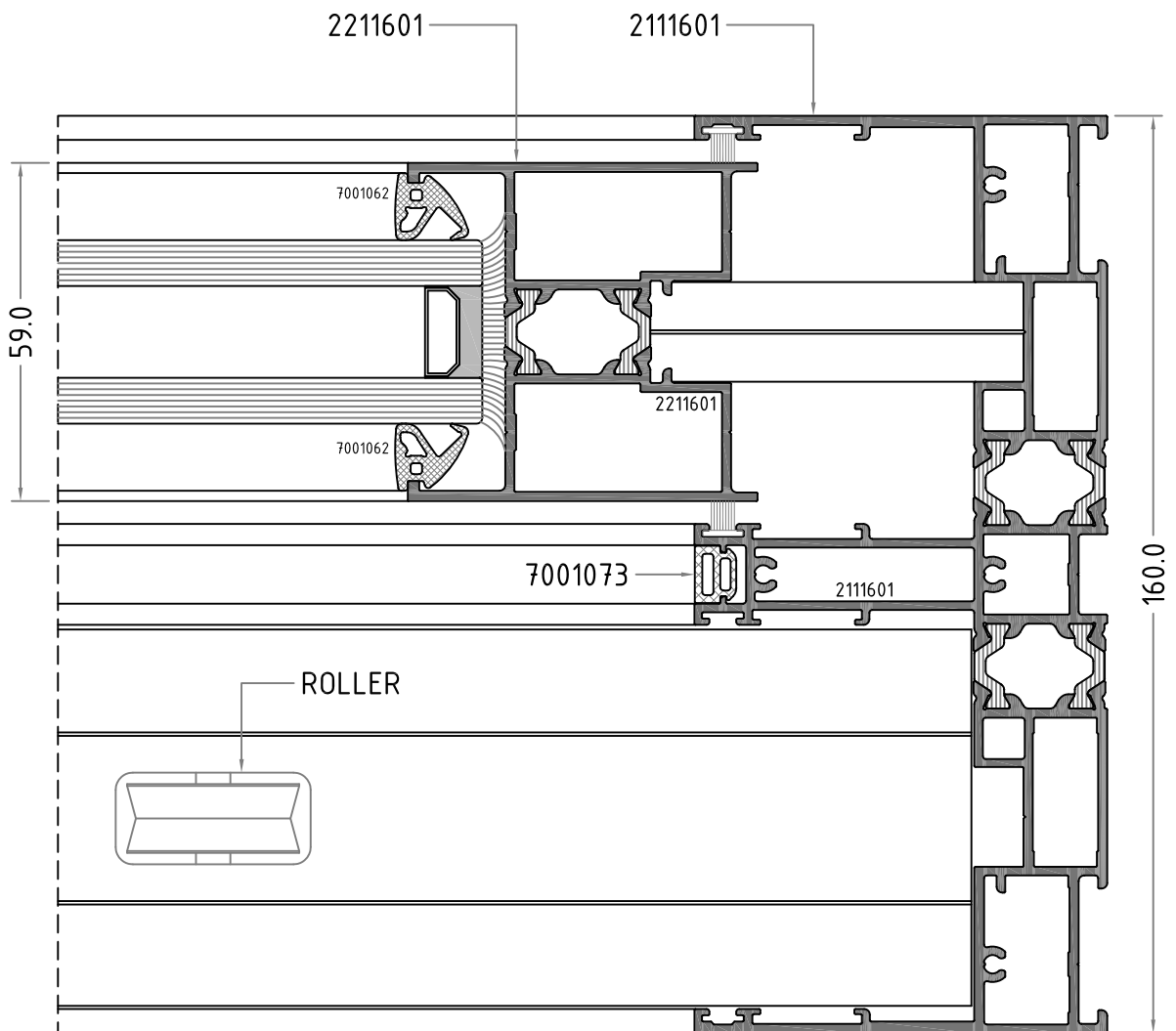
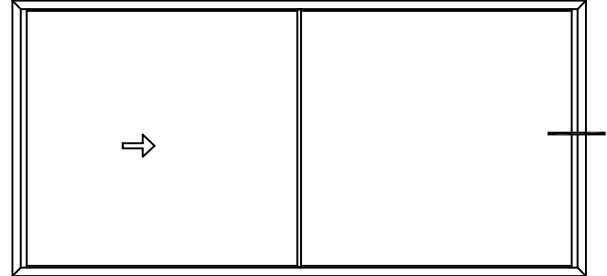

MOTORIZED OPENING

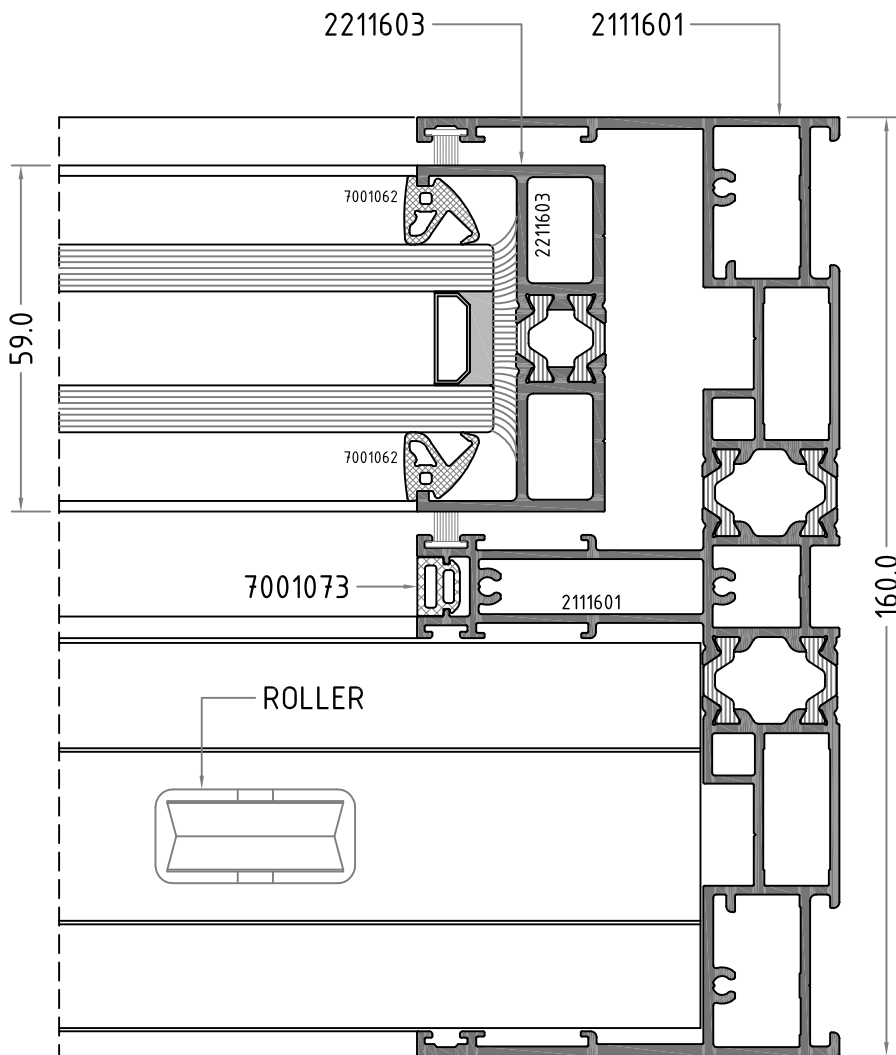
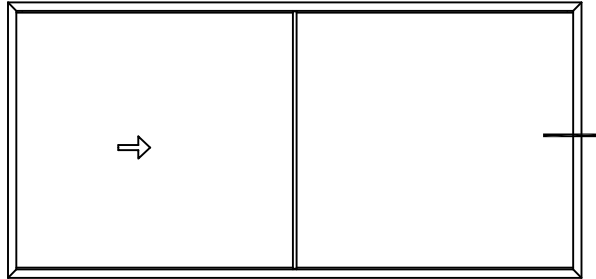

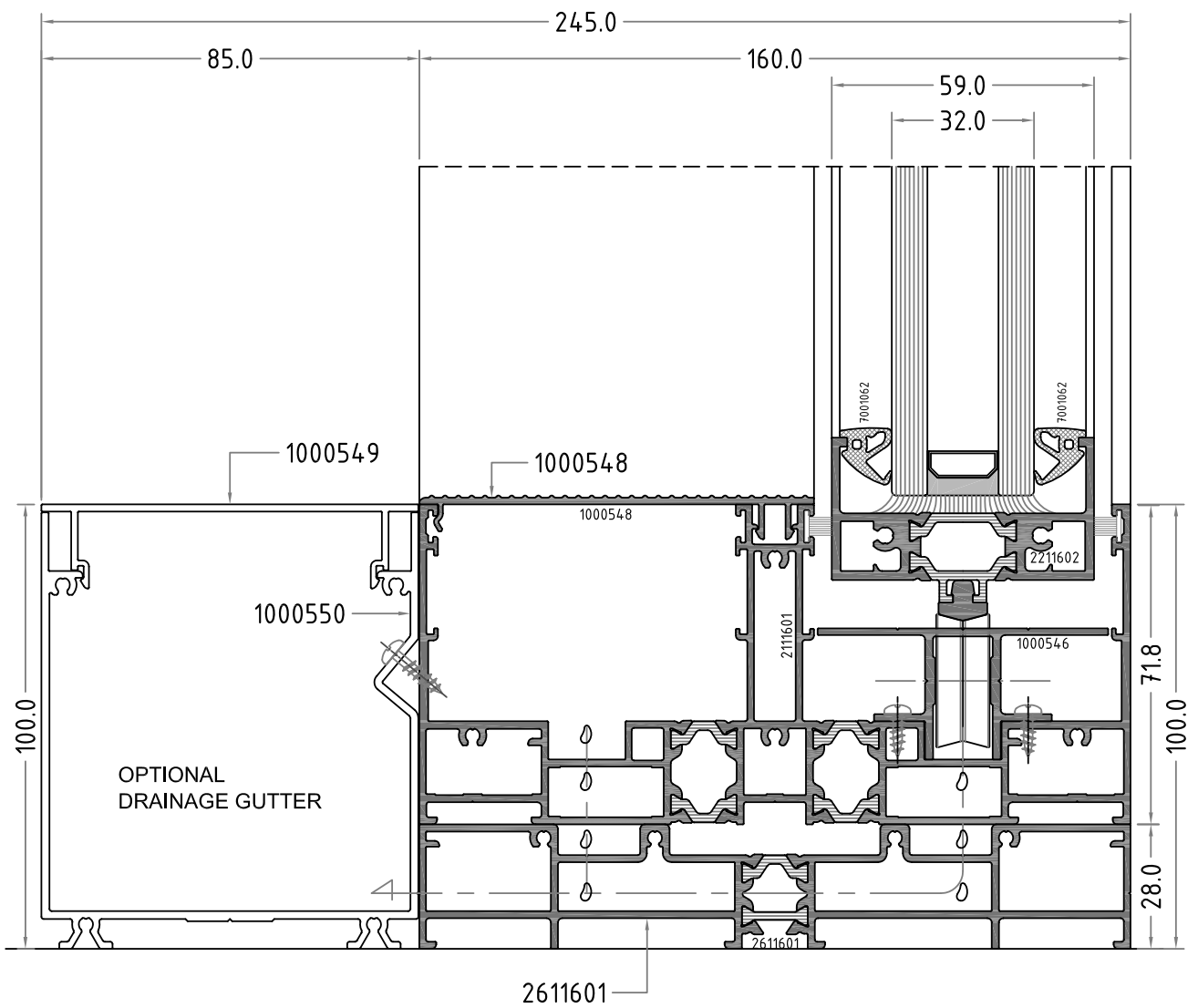
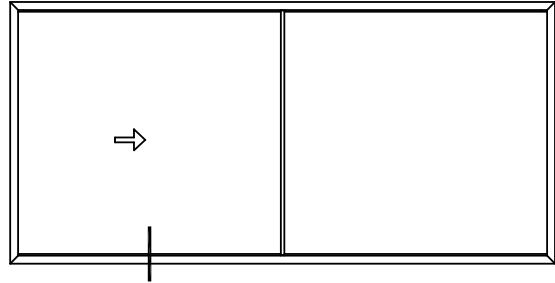

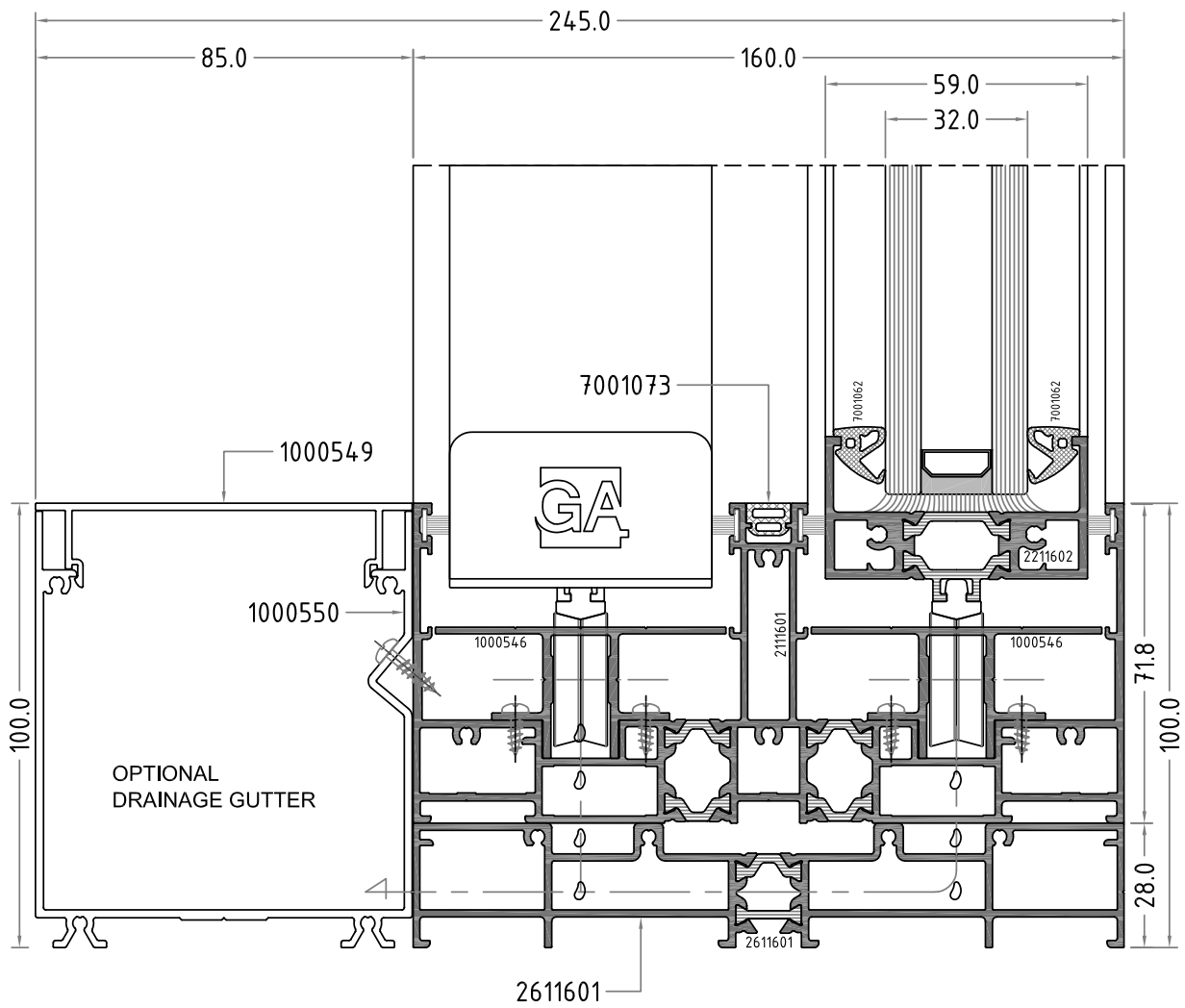
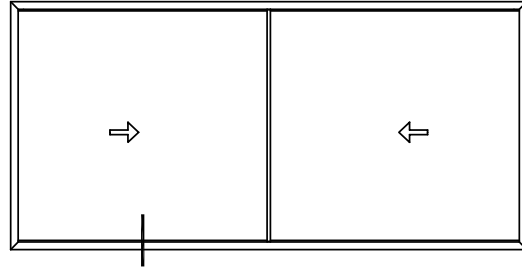

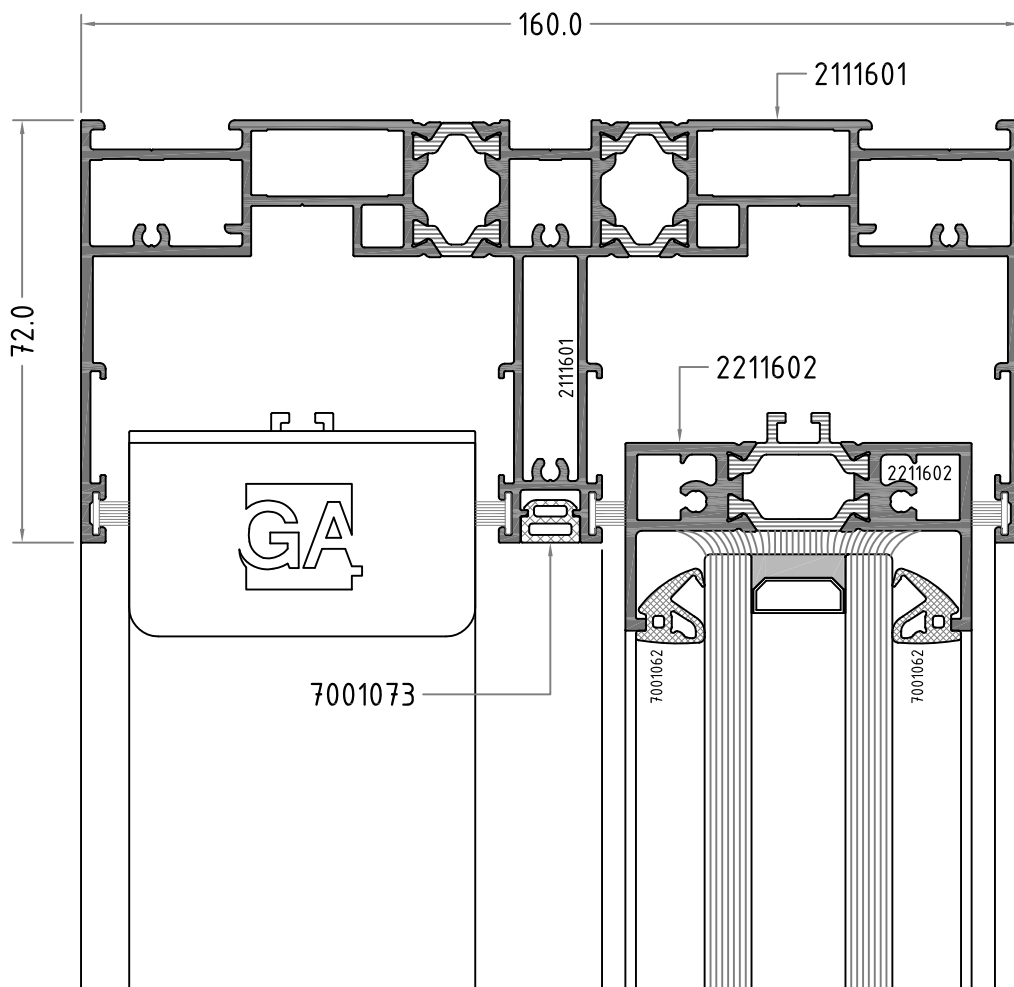
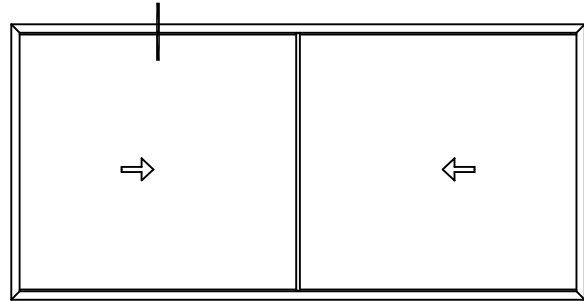

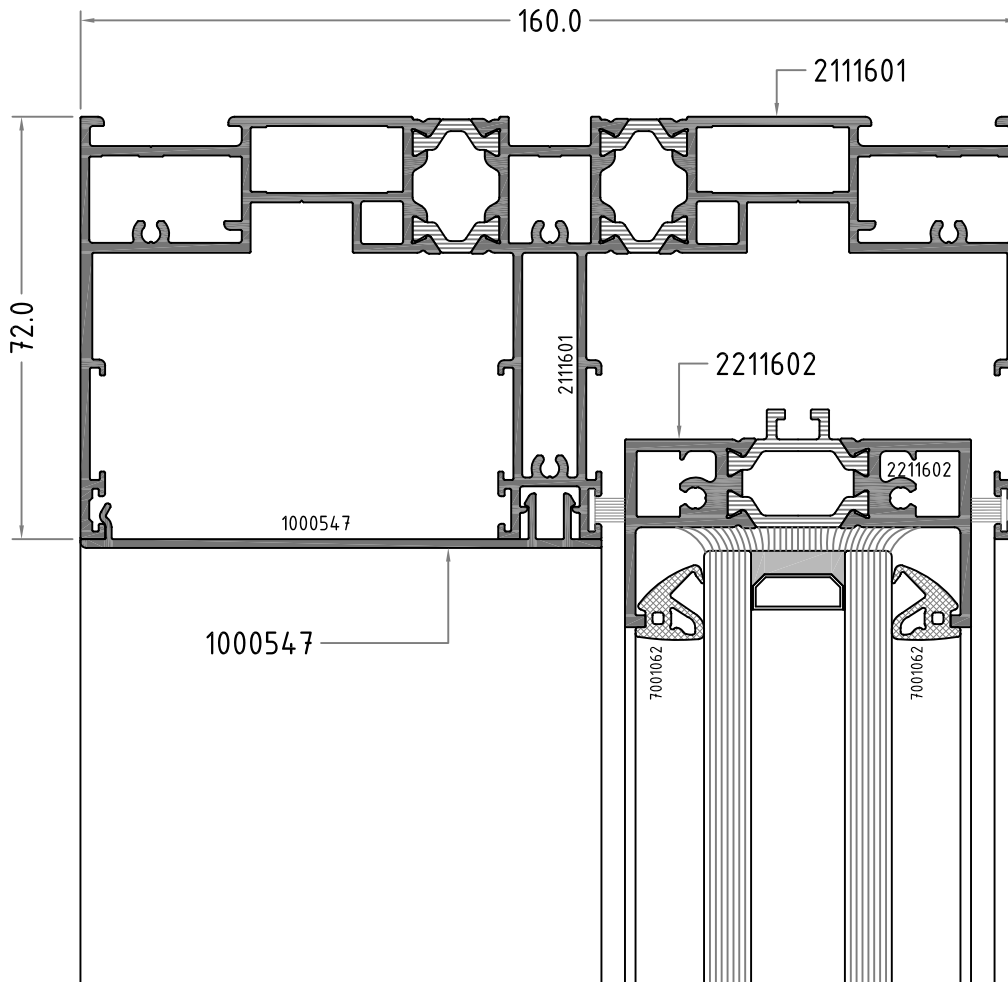
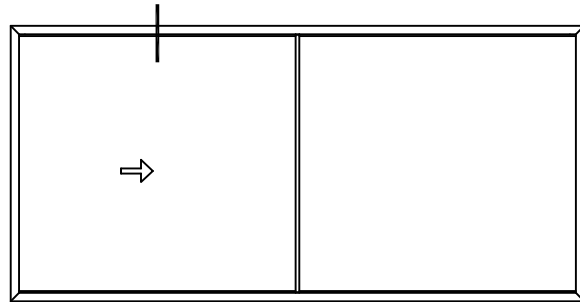

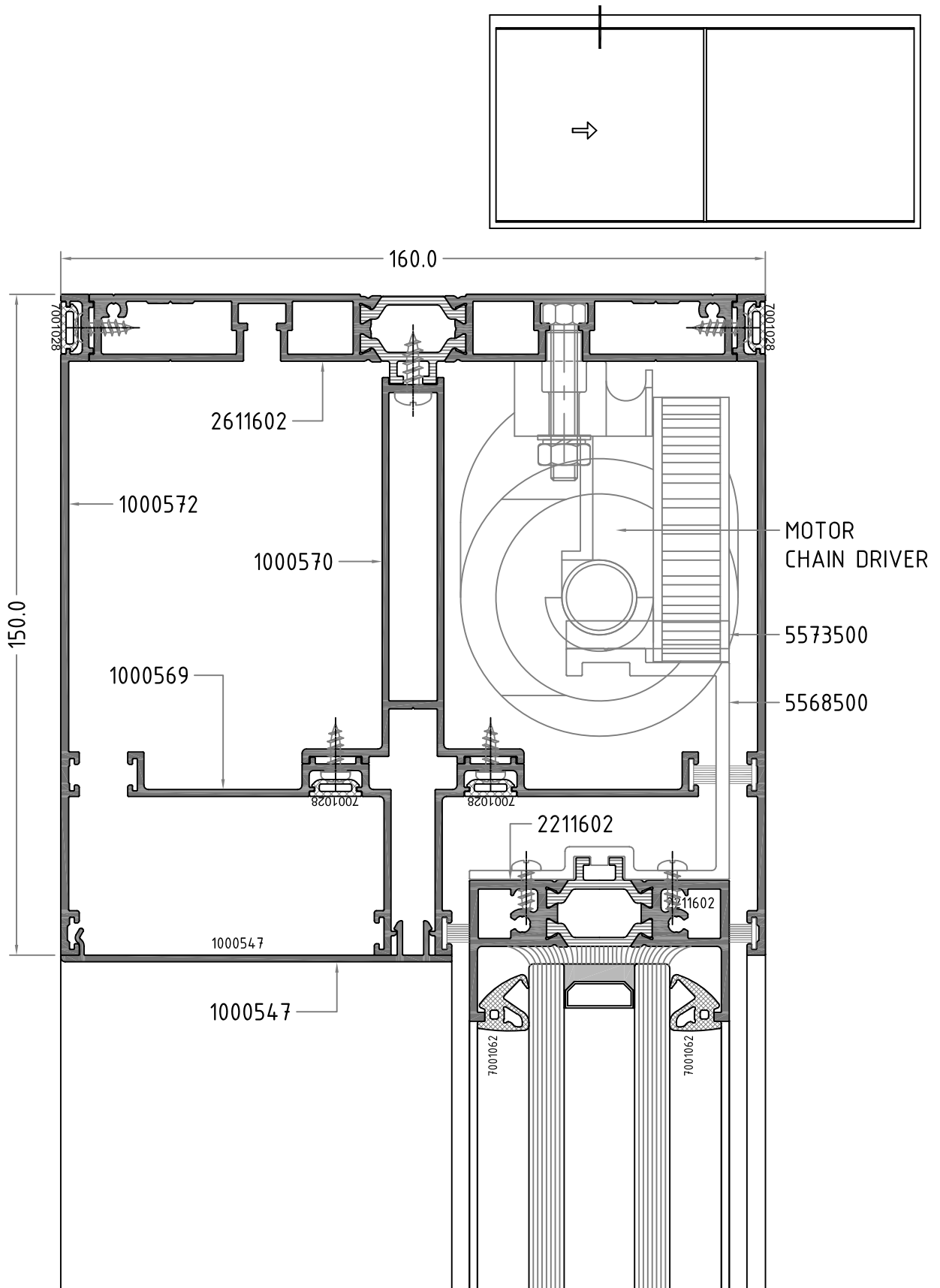

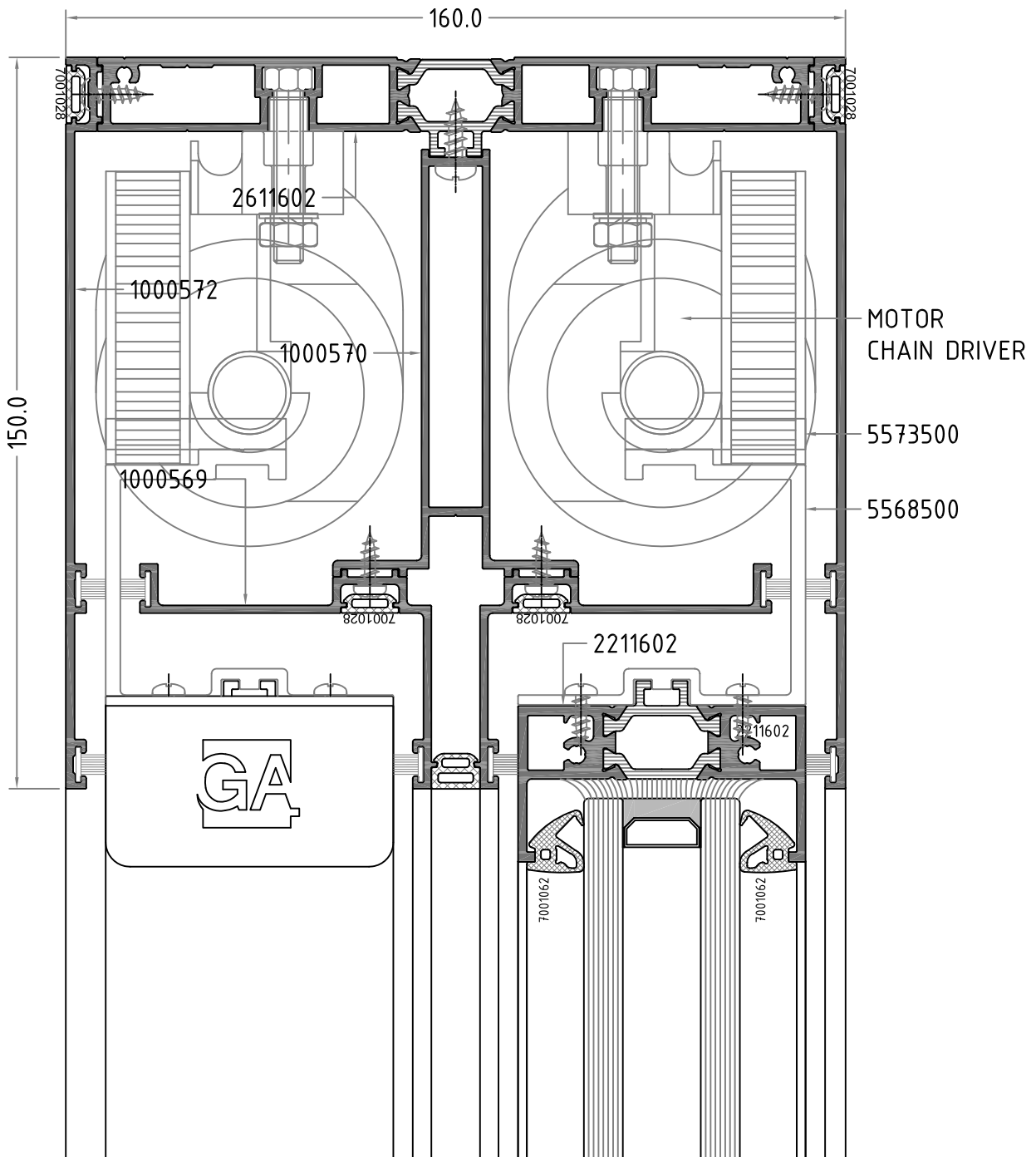
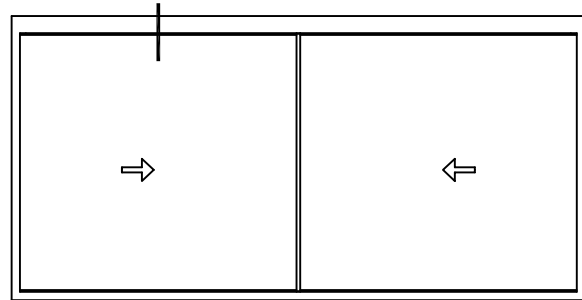

GLAZING TABLE
 GS 160 PD
 DOUBLE AND TRIPLE GLAZING

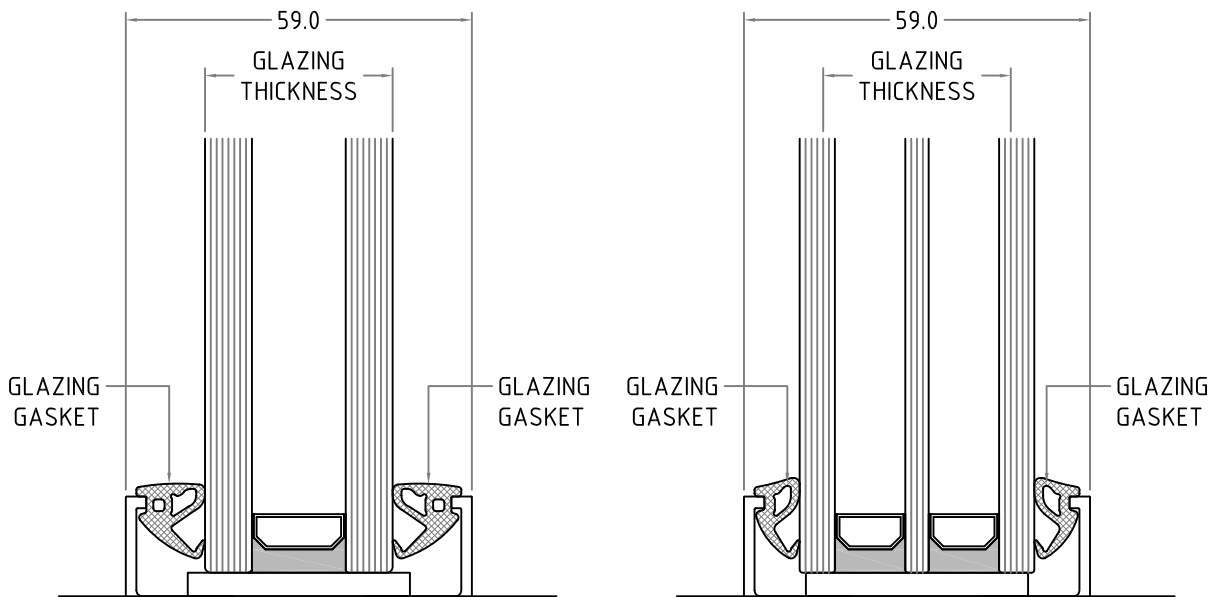

GLAZING THICKNESS	OUTER GLAZING GASKET	INNER GLAZING GASKET	OUTER GLAZING GASKET TICK.	INNER GLAZING GASKET TICK.
32 mm.	7001062	7001062	10 mm.	10 mm.
36 mm.	7001002	7001002	8 mm.	8 mm.
40 mm.	7001005	7001005	6 mm.	6 mm.
44 mm.	7001034	7001034	4 mm.	4 mm.