

**72ESHI**

**ECO SLIDE SYSTEM**

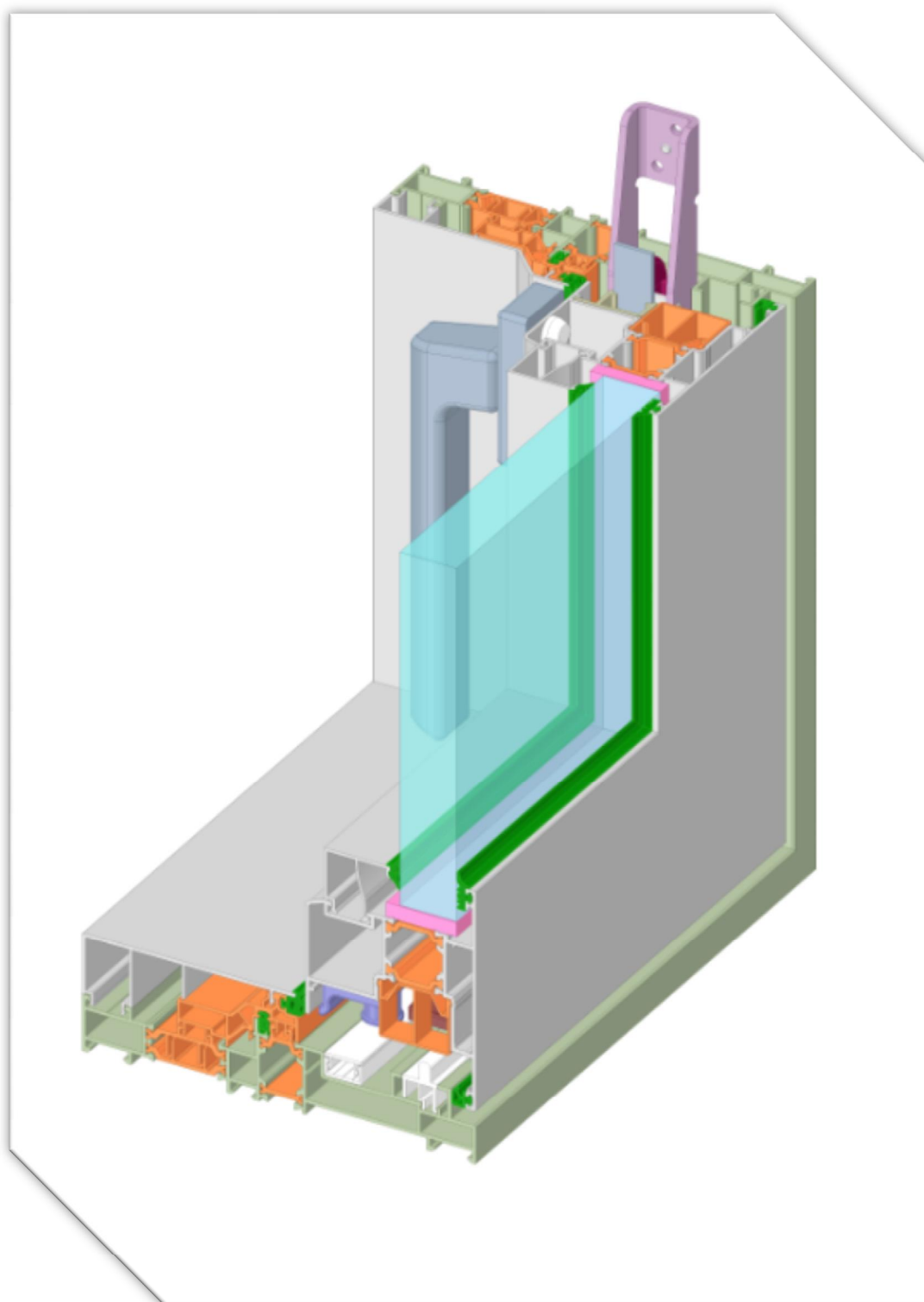

**72ESHI**  
**ECO SLIDE SYSTEM**

**PROFILES / PROFILLER**

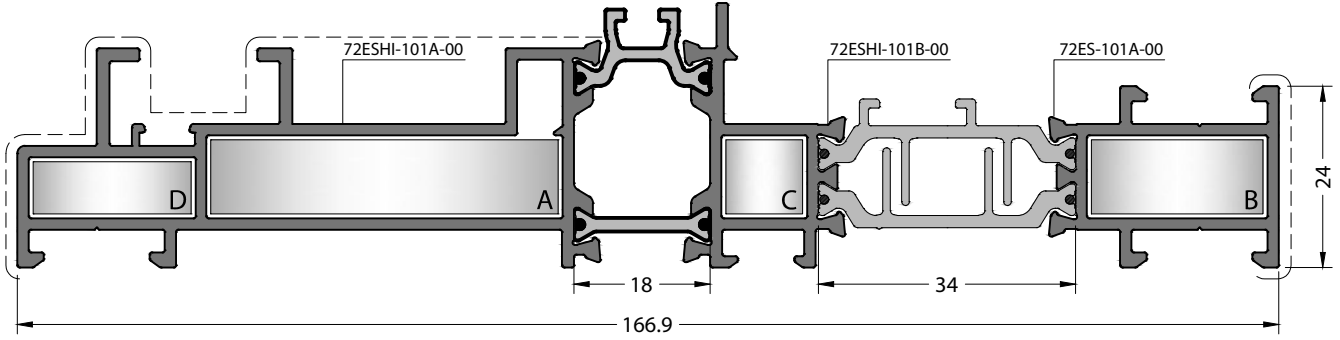

**CODE / KOD**  
**72ESHI-101-00**

**THEORETICAL WEIGHT kg/m**  
TEORİK AĞIRLIK kg/m  
**2.429**

**CORNER JOINTS**  
KÖŞE BAĞLANTILAR



**A** CC-101-46.6



**B** CC-101-23.4



**C** CC-101-10.8



**D** CC-107-21.6

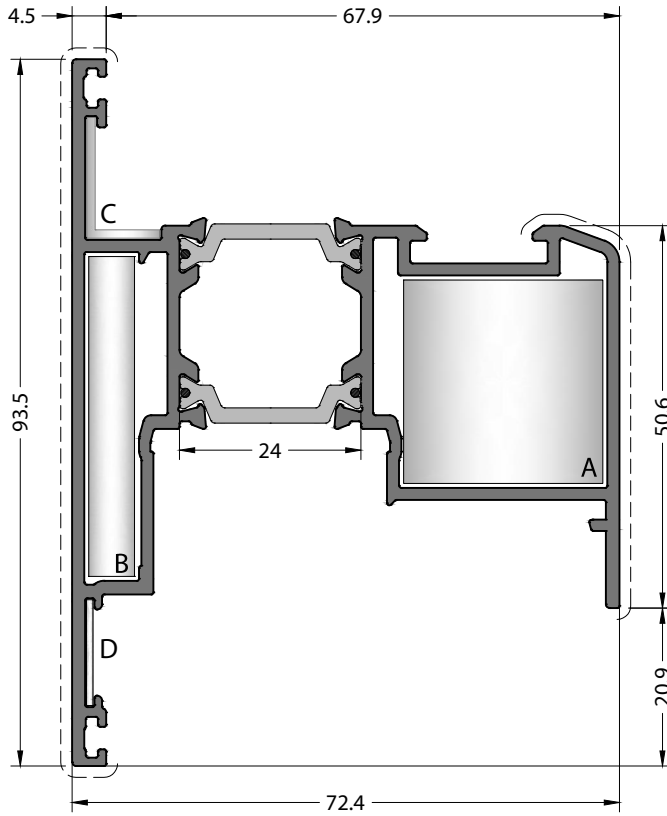

**CODE / KOD**  
**72ES-201-00**

**THEORETICAL WEIGHT kg/m**  
TEORİK AĞIRLIK kg/m  
**1.810**

**CORNER JOINTS**  
KÖŞE BAĞLANTILAR



**A** CC-120-26.7



**B** CC-105-06.7



**C** EM58-22



**D** MK-20.1

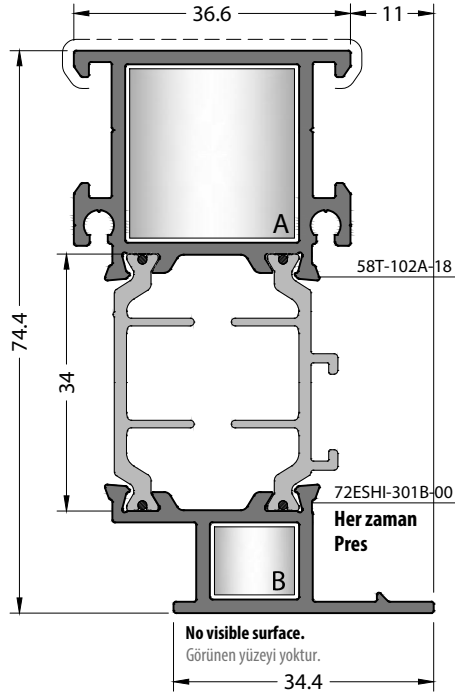

**CODE / KOD**  
**72ESHI-301-00**

**THEORETICAL WEIGHT kg/m**  
TEORİK AĞIRLIK kg/m

**1.398**

**CORNER JOINTS**  
KÖŞE BAĞLANTILAR



**A** CC-903-22.5



**B** CC72-901-11.3

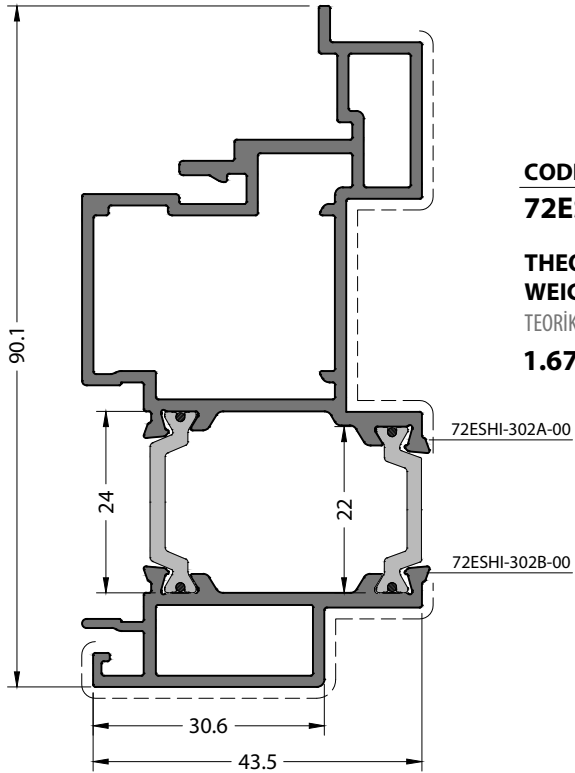

**CODE / KOD**  
**72ESHI-302-00**

**THEORETICAL WEIGHT kg/m**  
TEORİK AĞIRLIK kg/m

**1.677**

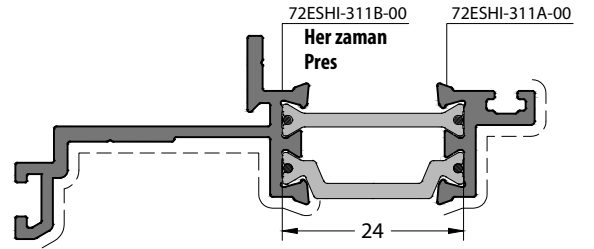

**CODE / KOD**  
**72ESHI-311-00**

**THEORETICAL WEIGHT kg/m**  
TEORİK AĞIRLIK kg/m

**0.733**

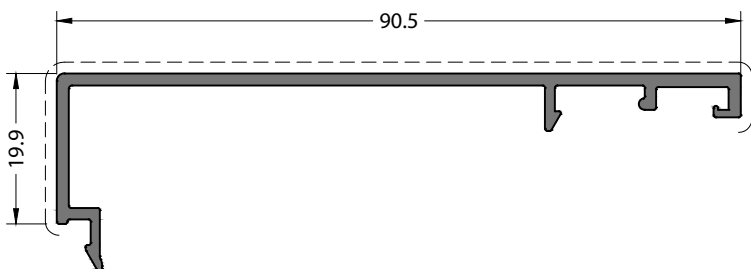

**CODE / KOD**  
**72ESHI-501-00**

**THEORETICAL WEIGHT kg/m**  
TEORİK AĞIRLIK kg/m  
**0.577**

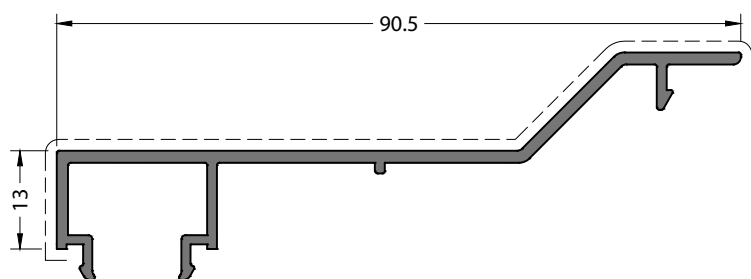

**CODE / KOD**  
**72ESHI-401-00**

**THEORETICAL WEIGHT kg/m**  
TEORİK AĞIRLIK kg/m  
**0.581**

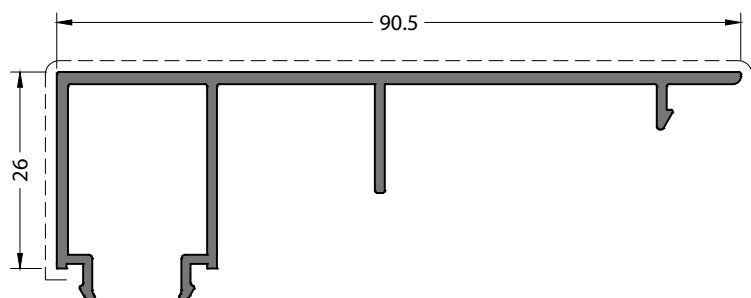

**CODE / KOD**  
**72ESHI-402-00**

**THEORETICAL WEIGHT kg/m**  
TEORİK AĞIRLIK kg/m  
**0.702**

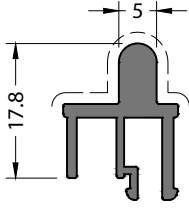

**CODE / KOD**  
**72ES-511-00**

**THEORETICAL WEIGHT kg/m**  
TEORİK AĞIRLIK kg/m  
**0.284**

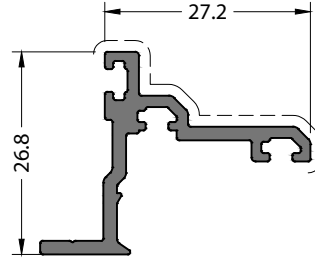

**CODE / KOD**  
**72ESHI-512-00**

**THEORETICAL WEIGHT kg/m**  
TEORİK AĞIRLIK kg/m  
**0.365**

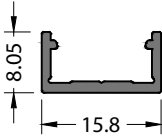

**CODE / KOD**  
**72ES-513-00**

**THEORETICAL WEIGHT kg/m**  
TEORİK AĞIRLIK kg/m  
**0.107**

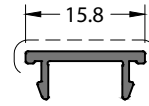

**CODE / KOD**  
**72ES-514-00**

**THEORETICAL WEIGHT kg/m**  
TEORİK AĞIRLIK kg/m  
**0.084**

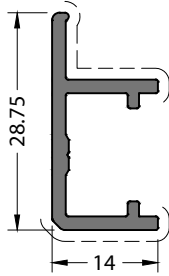

**CODE / KOD**  
**72ES-521-00**

**THEORETICAL WEIGHT kg/m**  
TEORİK AĞIRLIK kg/m  
**0.277**

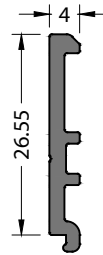

**CODE / KOD**  
**72ES-529-00**

**THEORETICAL WEIGHT kg/m**  
TEORİK AĞIRLIK kg/m  
**0.191**

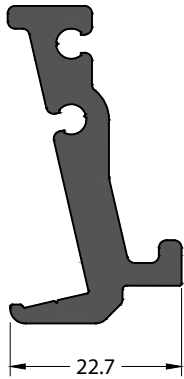

**No visible surface.**  
Görünen yüzeyi yoktur.

**CODE / KOD**  
**09-903-00**

**THEORETICAL WEIGHT kg/m**  
TEORİK AĞIRLIK kg/m  
**0.846**

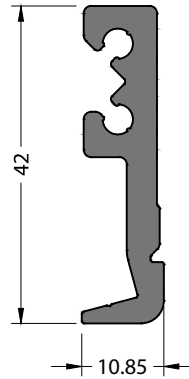

**No visible surface.**  
Görünen yüzeyi yoktur.

**CODE / KOD**  
**72ES-901-00**

**THEORETICAL WEIGHT kg/m**  
TEORİK AĞIRLIK kg/m  
**0.641**

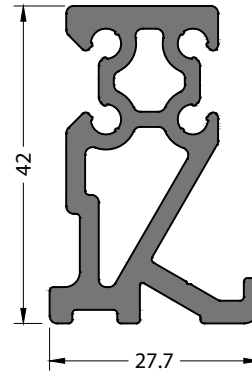

**No visible surface.**  
Görünen yüzeyi yoktur.

**CODE / KOD**  
**72ES-902-00**

**THEORETICAL WEIGHT kg/m**  
TEORİK AĞIRLIK kg/m  
**1.072**

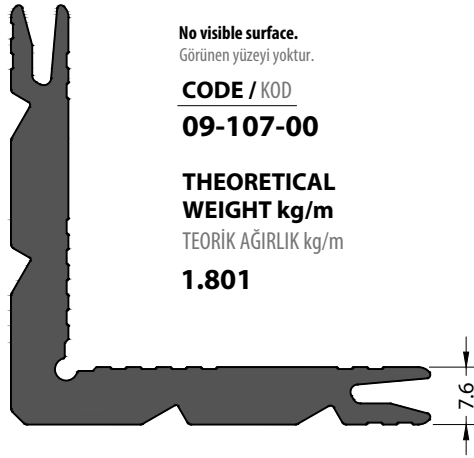

No visible surface.  
Görünen yüzeyi yoktur.

**CODE / KOD**  
**09-107-00**

**THEORETICAL WEIGHT kg/m**  
TEORİK AĞIRLIK kg/m  
**1.801**



No visible surface.  
Görünen yüzeyi yoktur.

**CODE / KOD**  
**09-101-00**

**THEORETICAL WEIGHT kg/m**  
TEORİK AĞIRLIK kg/m  
**2.561**

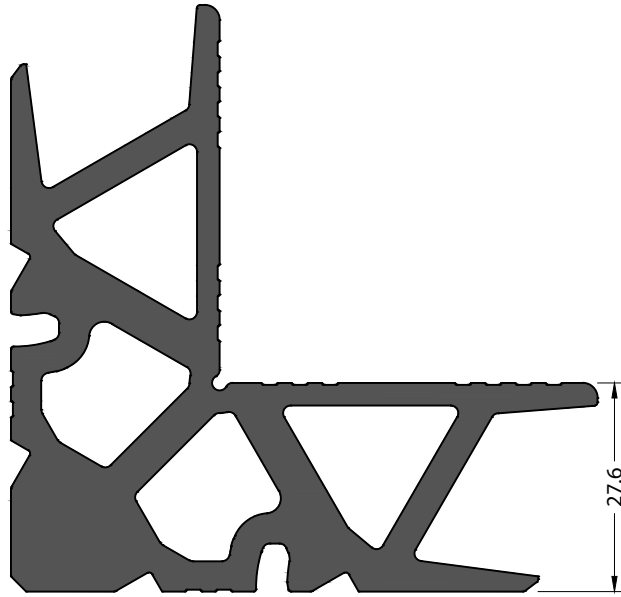

No visible surface.  
Görünen yüzeyi yoktur.

**CODE / KOD**  
**09-120-00**

**THEORETICAL WEIGHT kg/m**  
TEORİK AĞIRLIK kg/m  
**4.303**

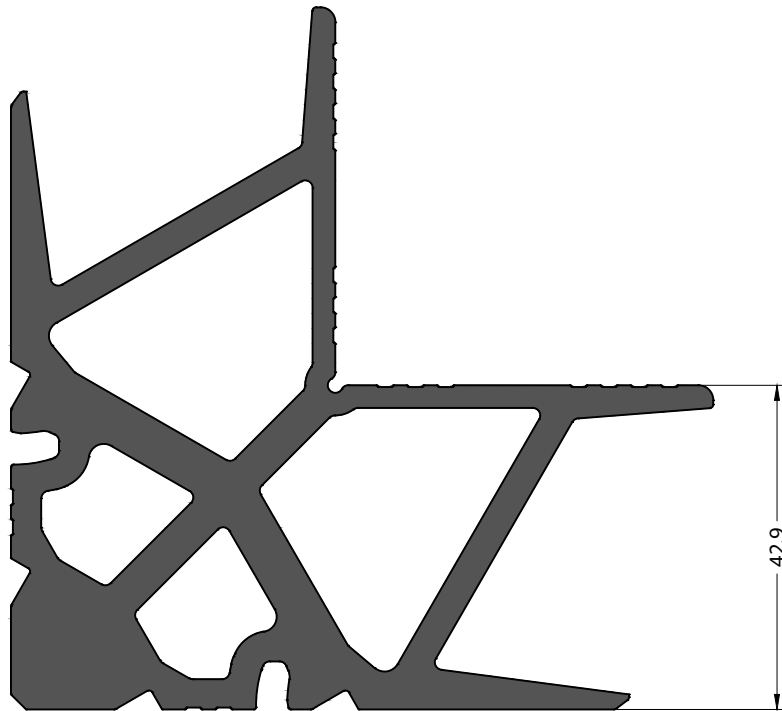

No visible surface.  
Görünen yüzeyi yoktur.

**CODE / KOD**  
**09-105-00**

**THEORETICAL WEIGHT kg/m**  
TEORİK AĞIRLIK kg/m  
**5.473**





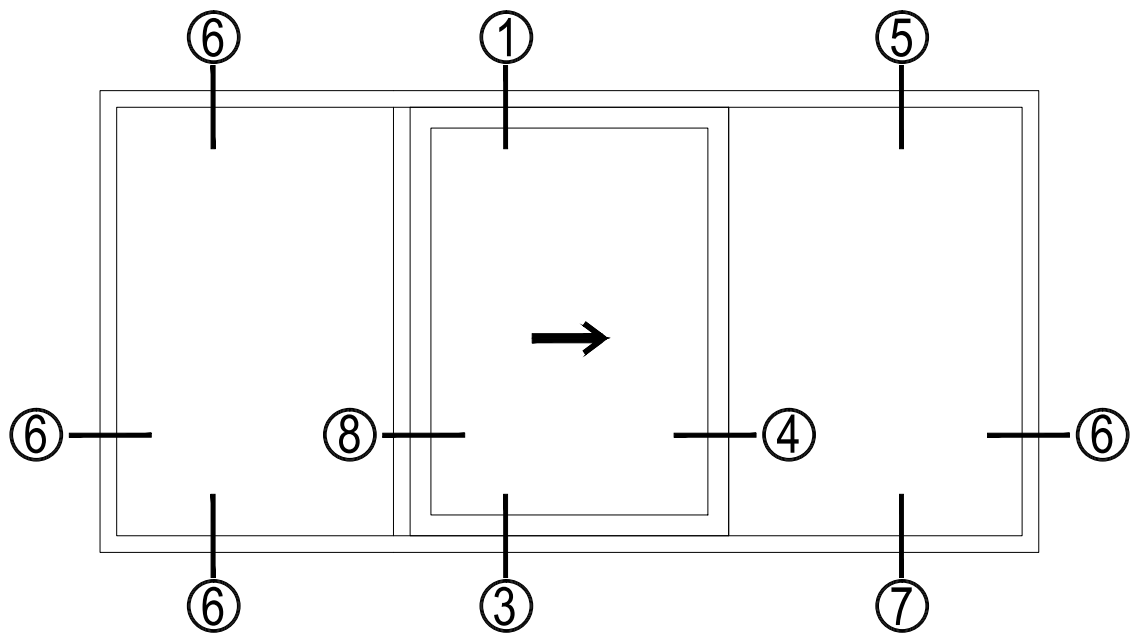
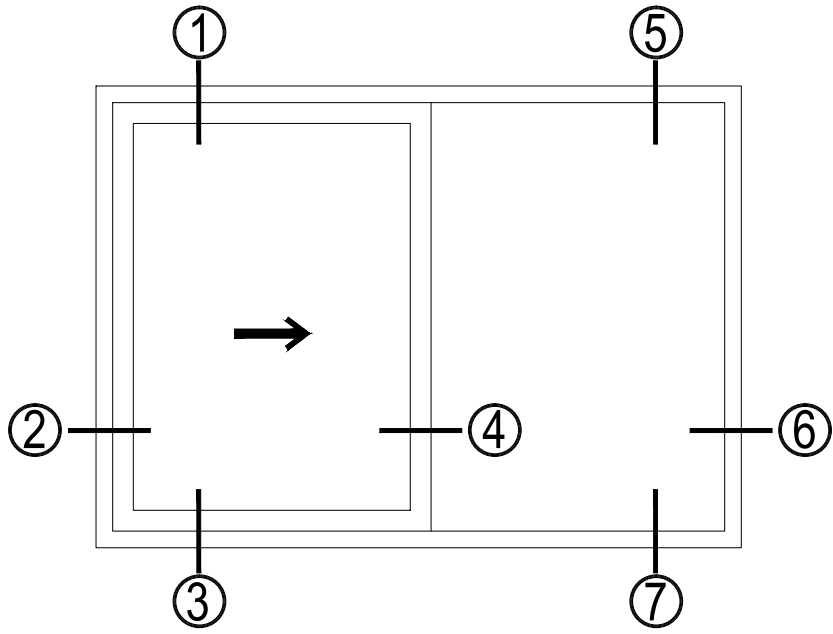

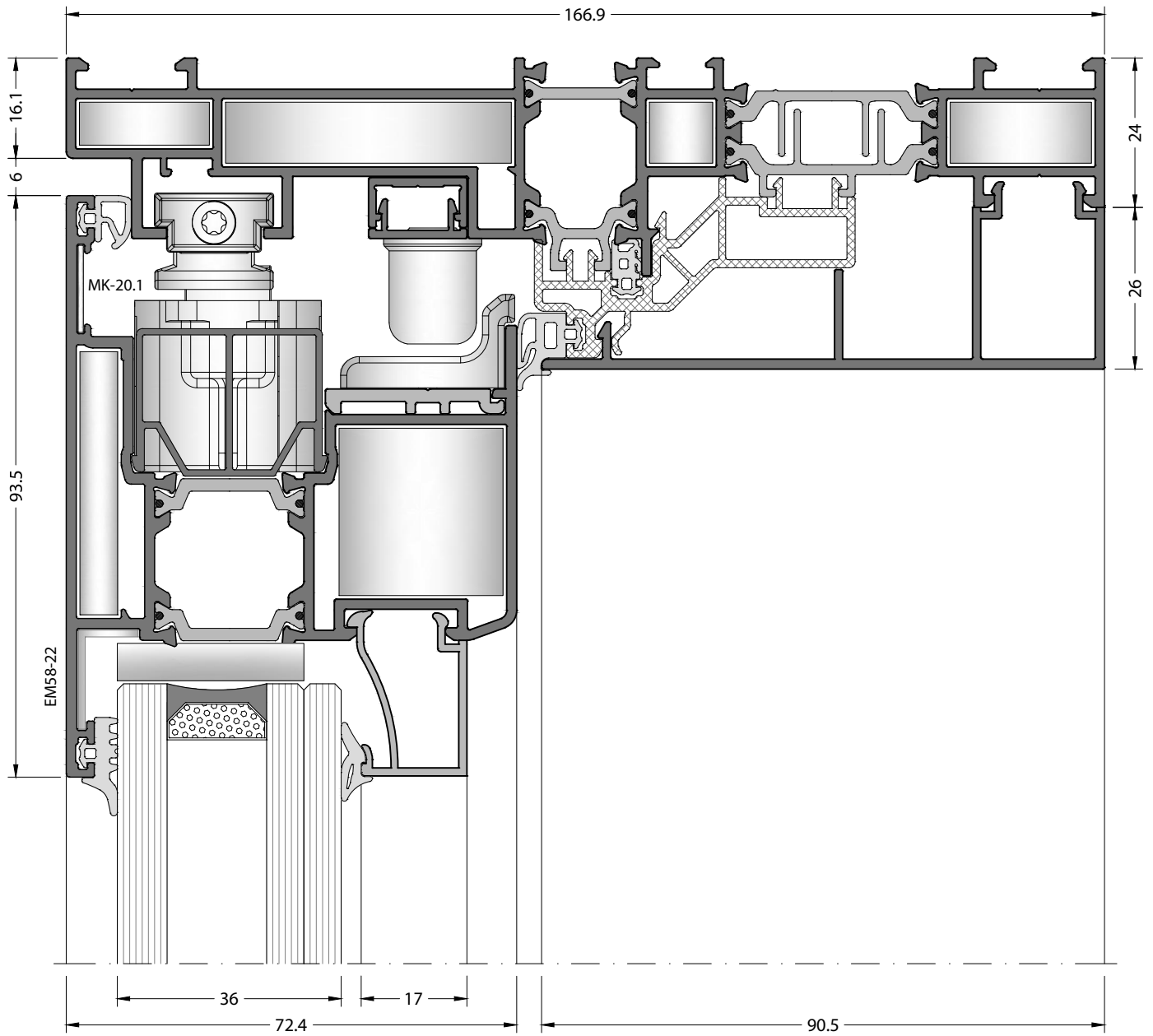
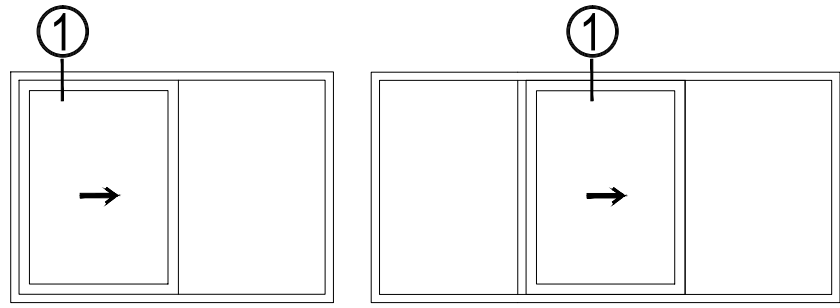

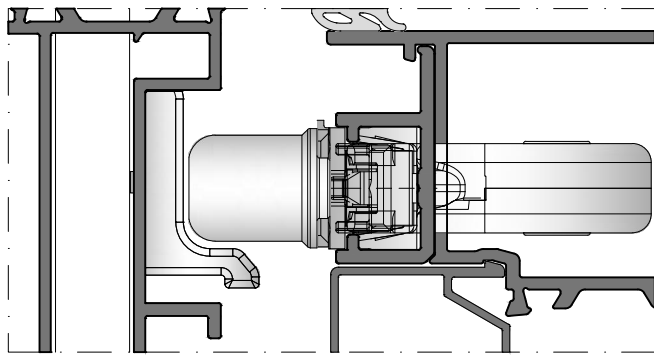

A DETAIL

②

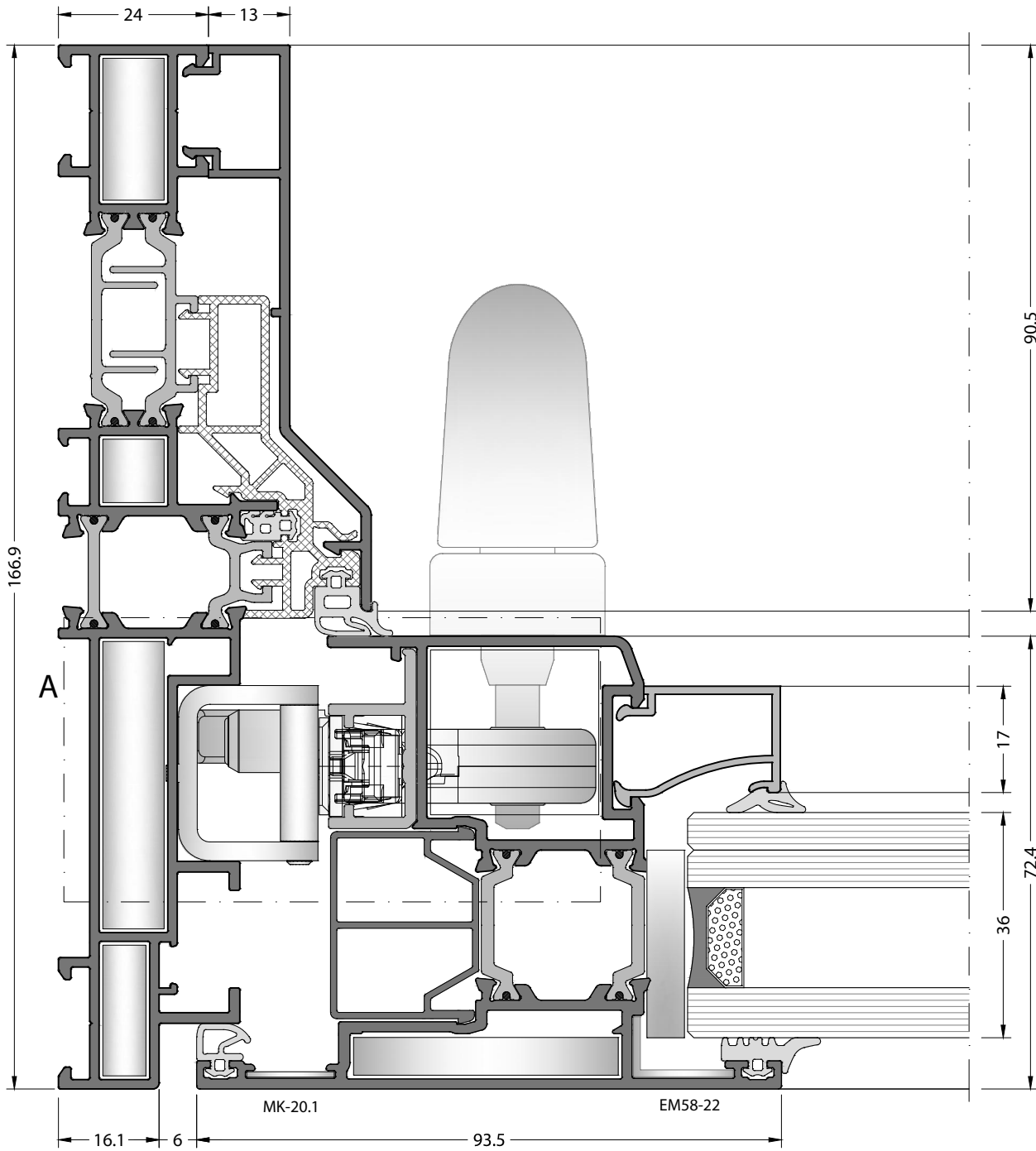
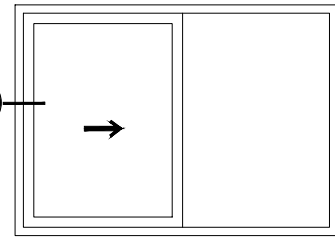

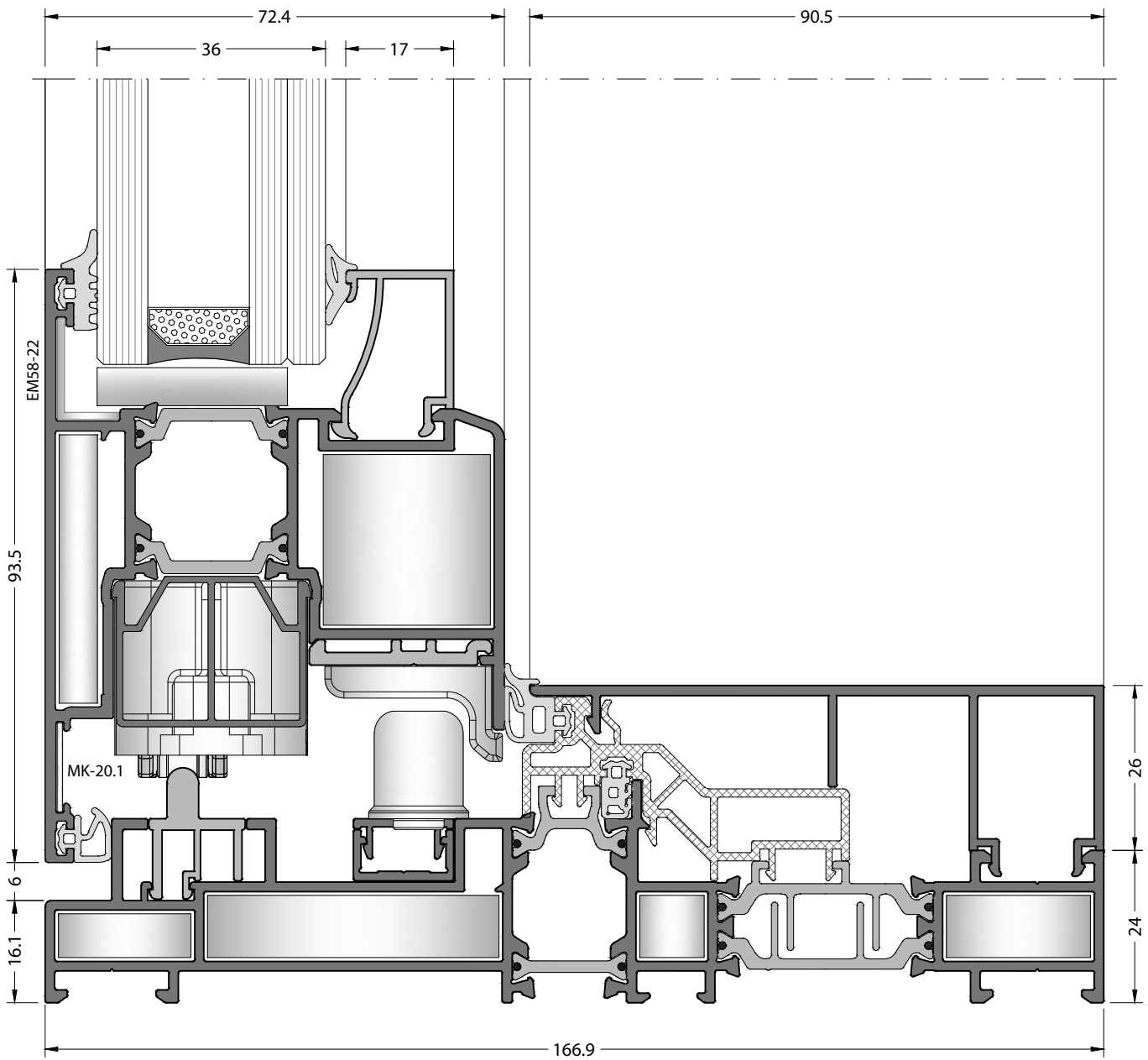
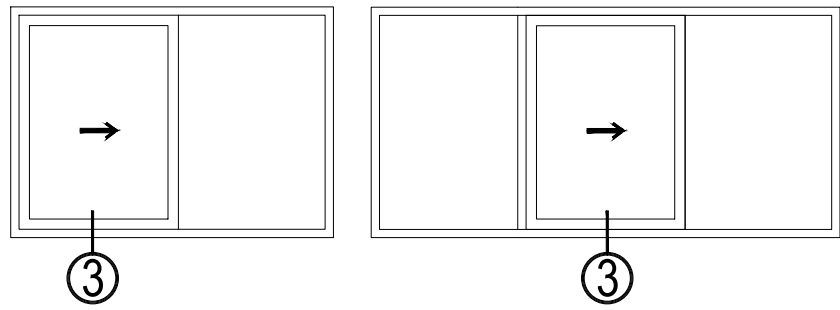

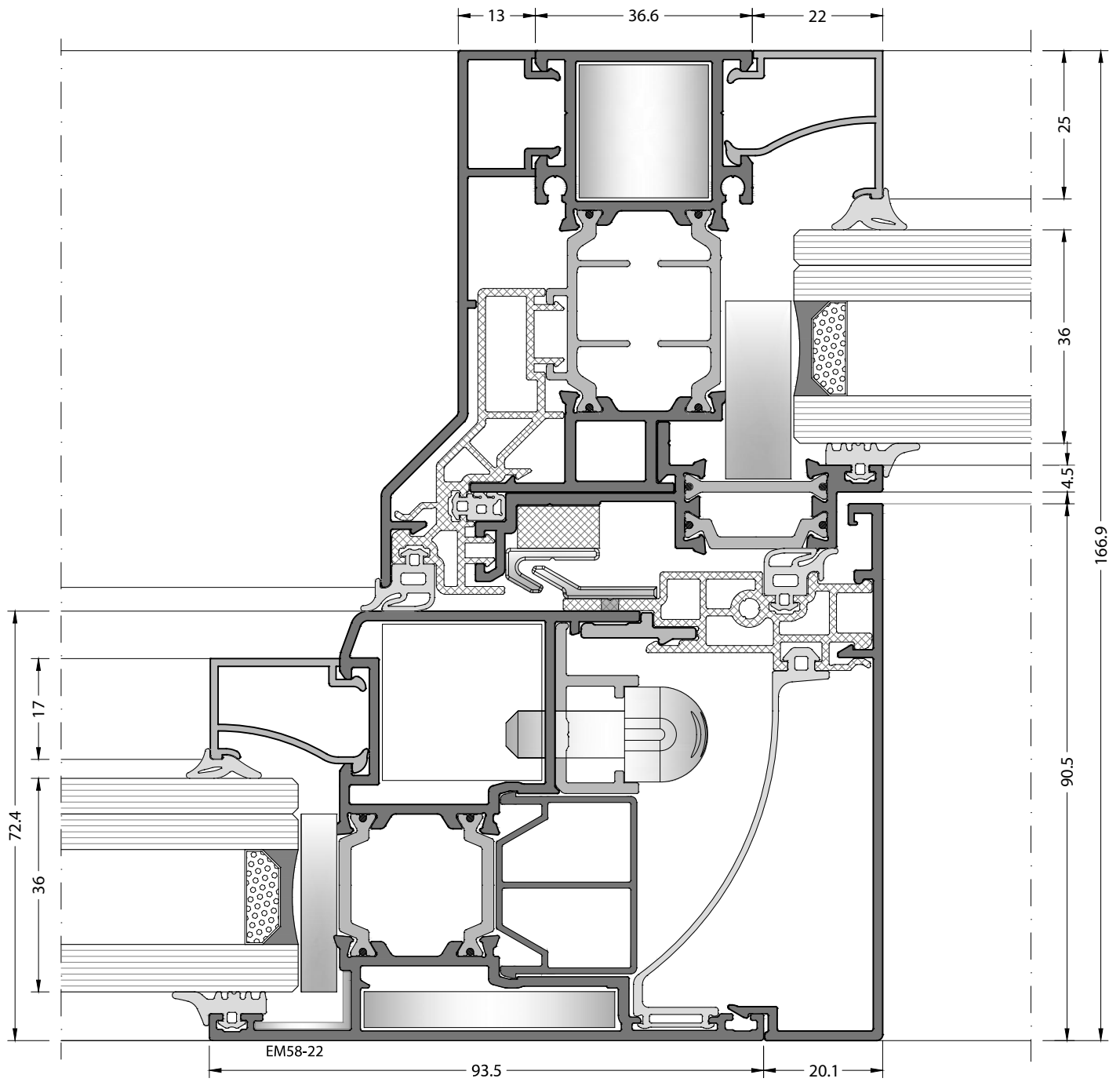
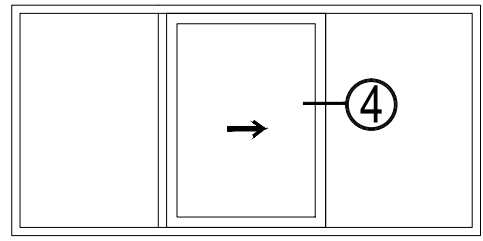
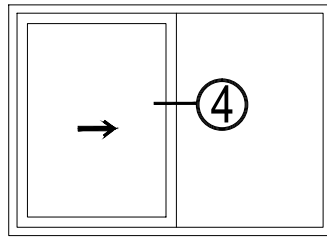

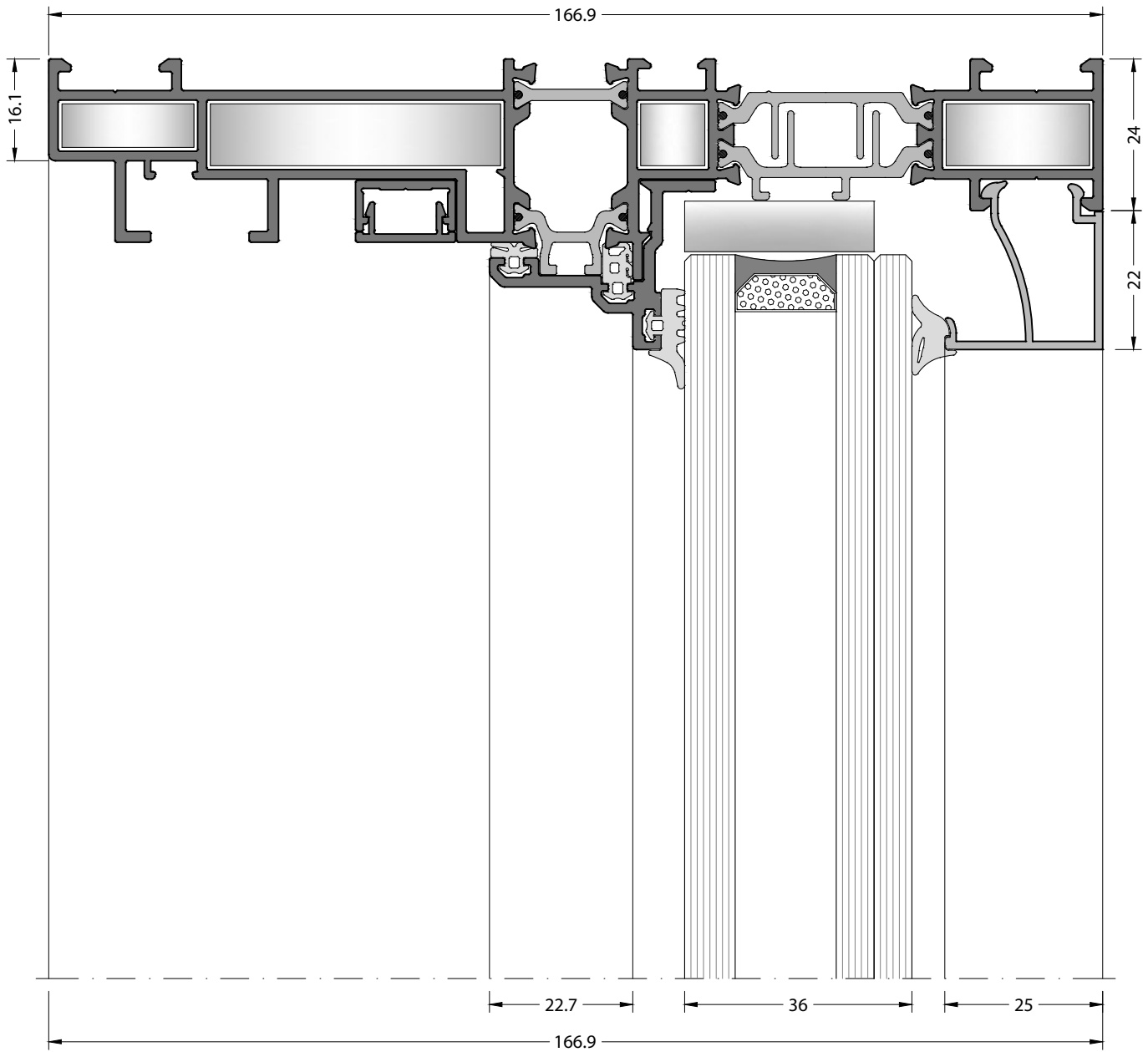
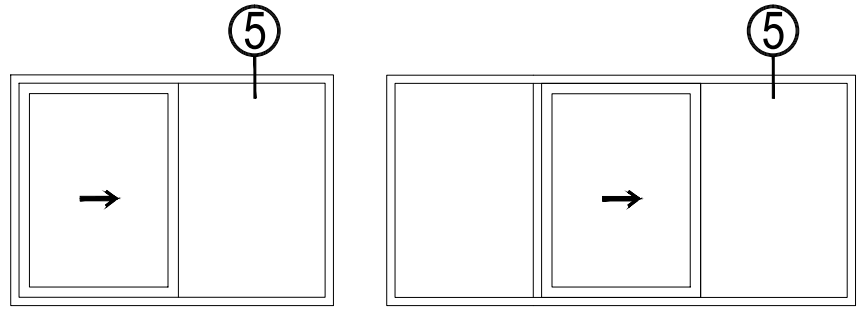

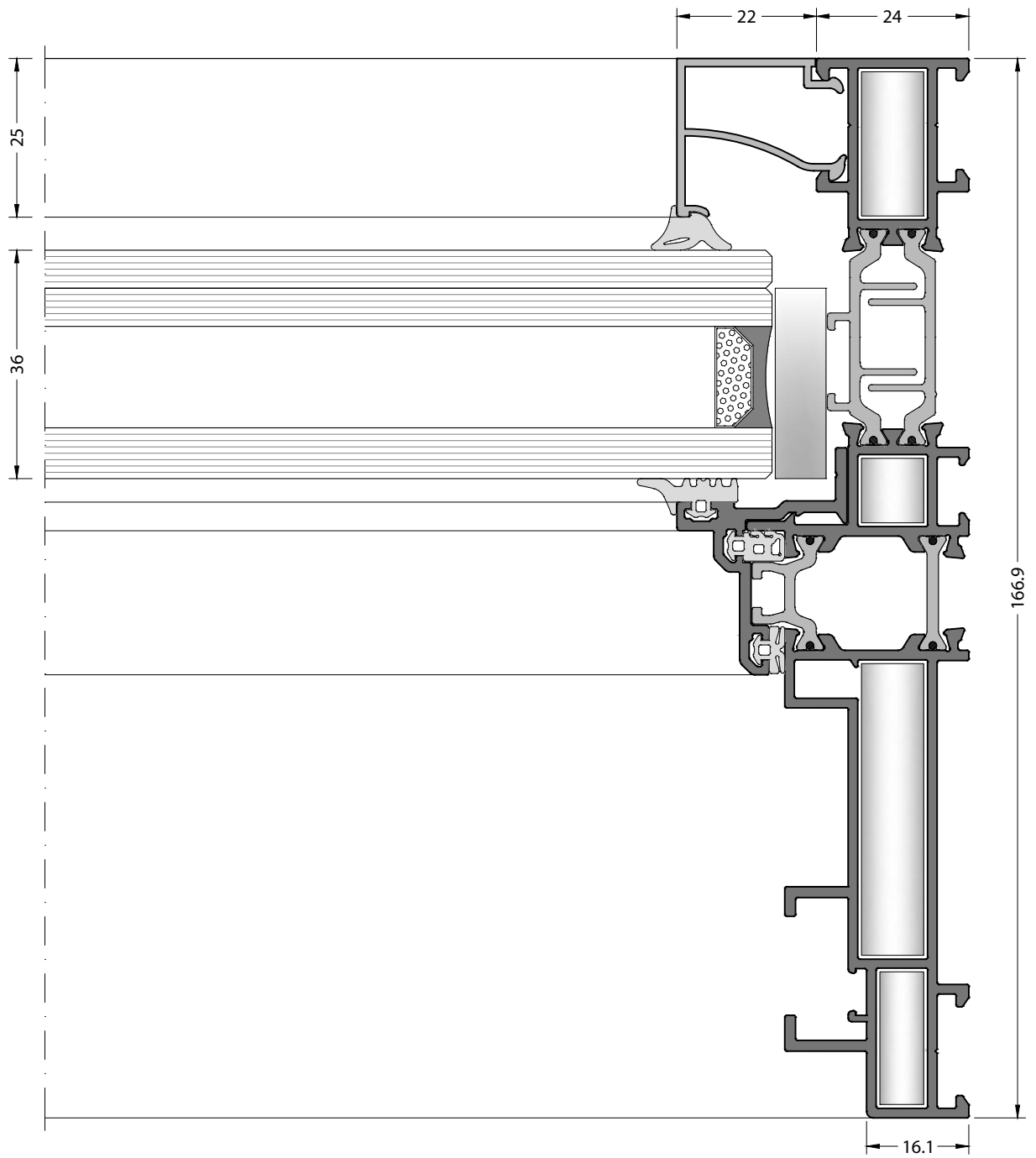
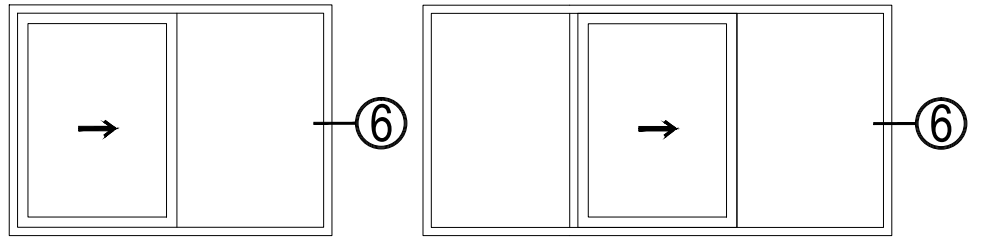





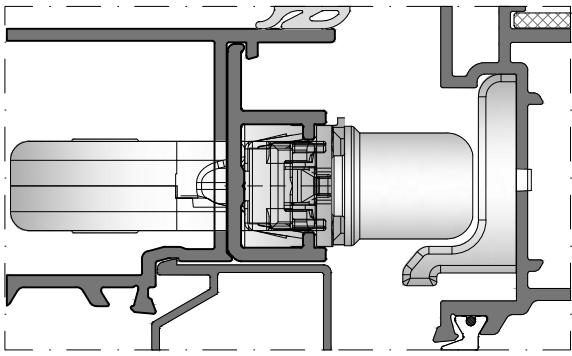

A DETAIL

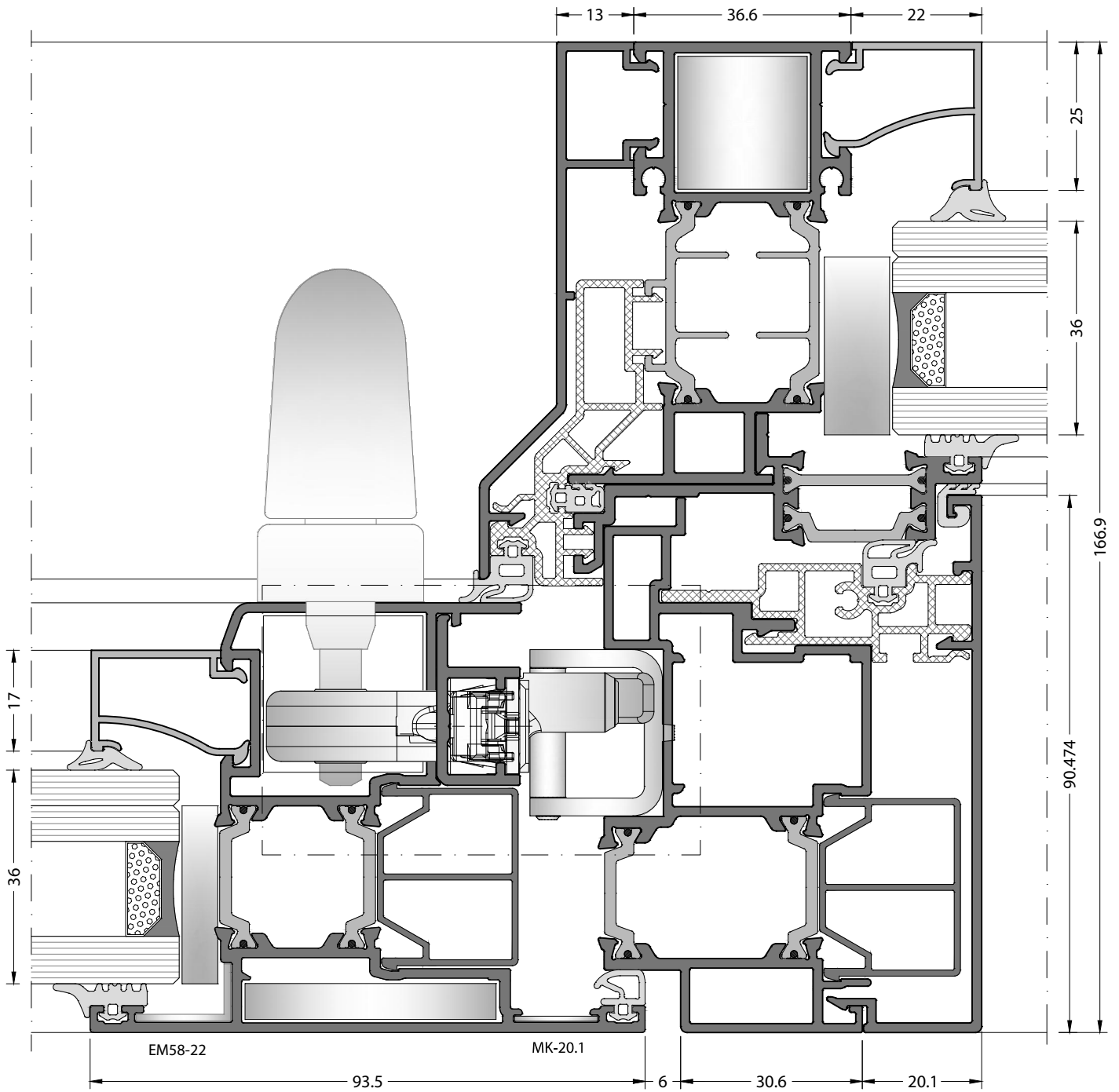
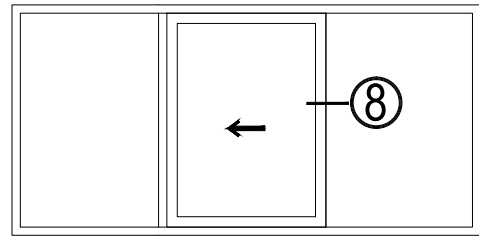









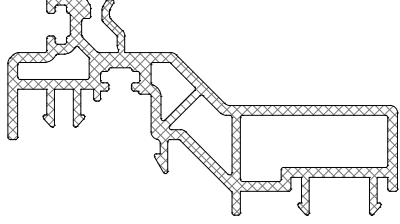
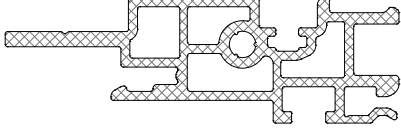
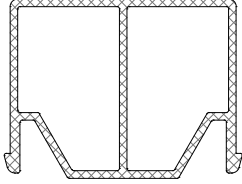

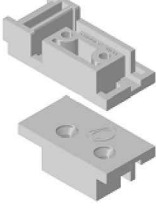

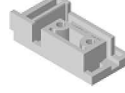
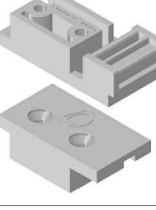

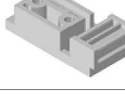
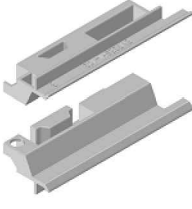
## GASKETS / FİTİLLER

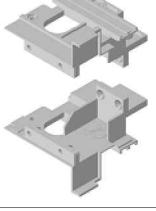
CODE / KOD	DRAWING / ÇİZİM	APPLICATION UYGULAMA	DESCRIPTION AÇIKLAMA	MATERIAL MALZEME	WEIGHT AĞIRLIK Kg/m	IN ONE PACKAGE PAKET MİKTARI
EM1-02			GLAZING GASKET INSIDE İÇ CAM FİTİLİ	EPDM	0.040	375 m
EM1-03			GLAZING GASKET INSIDE İÇ CAM FİTİLİ	EPDM	0.050	300 m
EM1-04			GLAZING GASKET INSIDE İÇ CAM FİTİLİ	EPDM	0.065	230 m
EM2-03			GLAZING GASKET OUTSIDE DIŞ CAM FİTİLİ	EPDM	0.069	215 m
EM72ES-11			CAPED GASKET KAPAK FİTİLİ	EPDM		
EM72ES-12			FRAME GASKET KASA FİTİLİ	EPDM		
EM72ES-21			SASH GASKET KANAT FİTİLİ	EPDM		
EM72ESHI-13			ADAPTER GASKET ADAPTÖR FİTİLİ	EPDM		
EM72ESHI-52			CAPED GASKET KAPAK FİTİLİ	EPDM		
EM72ES-51			CLAMPING GASKET KENET FİTİLİ	EPDM		

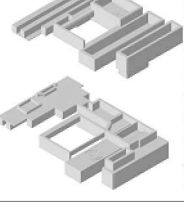
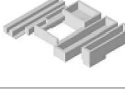
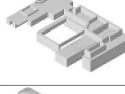
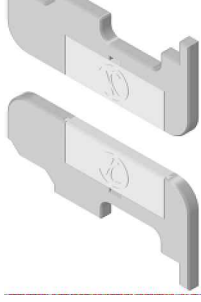
## PVC ADAPTER / PVC ADAPTÖR

CODE / KOD	DRAWING / ÇİZİM	APPLICATION UYGULAMA	DESCRIPTION AÇIKLAMA	MATERIAL MALZEME	WEIGHT AĞIRLIK kg/m	IN ONE PACKAGE PAKET MİKTARI
EM72-12			PVC PROFILE PVC PROFİL	PVC	-	6 METERS METRE
EM72-51			PVC PROFILE PVC PROFİL	PVC	-	6 METERS METRE
EM72-21			PVC PROFILE PVC PROFİL	PVC	-	6 METERS METRE

PACKAGE CODE PAKET KOD	VIEW RESİM	DESCRIPTION AÇIKLAMA	PIECE CODE PARÇA KOD	VIEW RESİM	DESCRIPTION AÇIKLAMA	IN ONE PACKAGE PAKET MİKTARI
EM72ES-101L		<b>WEATHER STRIP SETY (LEFT)</b> HAVA KESİCİ TAKIMI (SOL)	EM72ES-101 A		Weather Strip Left (Top) Hava Kesici Sol (Üst)	1
			EM72ES-101 B		Weather Strip Left (Bottom) Hava Kesici Sol (Alt)	1
EM72ES-101R		<b>WEATHER STRIP SETY (RIGHT)</b> HAVA KESİCİ TAKIMI (SAĞ)	EM72ES-101R A		Weather Strip Right (Top) Hava Kesici Sağ (Üst)	1
			EM72ES-101R B		Weather Strip Right (Bottom) Hava Kesici Sağ (Alt)	1
EM72ESHI-102		<b>INSULATION PLASTIC</b> İZOLASYON PLASTİĞİ	EM72ESHI-102 A		Insulation Plastic (Top) İzolasyon Plastiği (Üst)	1
			EM72ES-102 B		Insulation Plastic (Bottom) İzolasyon Plastiği (Alt)	1
EM72ES-201		<b>CLAMPING MAIN PLASTIC</b> KENET GÖVDE PLASTİĞİ	EM72ES-201 A		Clamping Main Plastic (Bottom) Kenet Gövde Plastiği (Alt)	1
			EM72ES-201 B		Clamping Main Plastic (Top) Kenet Gövde Plastiği (Üst)	1
EM72ESHI-302		<b>CONNECTION PLASTIC</b> BAĞLANTI PLASTİĞİ	EM72ESHI-302 A		Connection Plastic (Bottom) Bağlantı Plastiği (Alt)	1
			EM72ESHI-302 B		Connection Plastic (Top) Bağlantı Plastiği (Üst)	1
EM72ESHI-501		<b>CLAMPING ACCESSORIES SET</b> KENET AKSESUAR TAKIMI	EM72ESHI-501 A		Clamping Cap (Bottom) Kenet Kapağı (Alt)	1
			EM72ESHI-501 B		Clamping Cap (Top) Kenet Kapağı (Üst)	1
			EM72ES-501 K		Caped (Top & Bottom) Kapak (Üst & Alt)	2