

EDITION / VERSİYON
01/2011

ALUMINIUM BALUSTRADE PROFILES AND ACCESSORIES

ALÜMİNYUM KÜPEŞTE PROFİL VE AKSESUARLARI

 **Lorenzoline**[®]
aluminium profile system



MODERN HARMONY OF SAFETY AND AESTHETICS

The best way to draw reliable and
aesthetic border without losing your freedom...

INDEX / İÇİNDEKİLER

Company Information / Hakkımızda	02-03
Quality Policy / Kalite Politikamız	04
Code Logic / Kod Mantığı	05-06
Accessories Index / Aksesuar İndeks	08-25
Mini Profiles / Mini Profiller	28-30
Profiles / Profiller	32-44
Accessories / Aksesuarlar	46-69
Gürsan Accessories / Gürsan Aksesuarları	72-82
Application Details / Uygulama Detayları	84-103
Notes / Notlar	104-112

company information

The company started its work life with copper and lead casting in the 1960s and in the 1980s we started to serve in The Aluminium Sector with a 1200 ton capacity aluminium extrusion press.

KURTOĞLU Aluminium is located in Corlu, approximately 100 km faraway from Istanbul and it operates in 31.000 m² closed area.

According to our latest investments the company has become a full modern integrated aluminium extrusion company;

- Increasing its annual production capacity to ~ 34.000 tons,
- Working with ~ 400 qualified employers,
- Using the ISO 9001:2000 Management System.

The company's main production features are described as below:

- Tool Building,
- Aluminium Extrusion Presses, (800 us/tons , 1460 us/tons, 1880 us/tons, 1460/1880 us/tons , 2100 us/tons and 2600 us/tons),
- Anodized Facilities (According to Qualanod Standards), Capacity 91.000 A.
- Powder Coating Facilities (According to Qualicoat Standards),
- Mechanical (CNC Applications) Treatments.
- Wood effect, sending and other surface applications.

Kurtoglu Aluminium export its products to Switzerland, Germany, Austria, Greece, Cyprus, Bulgaria, Libya, Ganha, Russian Federation, Ukraine, Lithuania, Moldavia, Serbia, Montenegro, Hungary, Iran, Iraq, Armenia, Albania, Georgia, The Netherlands, Czech Republic, Isreal, Belarus, Azerbaijan, Turkmenistan, Tajikistan, Kyrgyzstan, Kazakhstan, Macedonia, Romania. Using the ISO 9001:2000 Management System as a base Kurtoglu Aluminium continue the drive towards zero defect for all customers.

firmamız hakkında

Şirketimiz 1960' lı yıllarda Bakır ve Kurşun ile üretim hayatına başlamıştır. 1980 yılında 1200 tonluk Alüminyum Ekstrüzyon presi ile üretim sektörüne girmiştir.

KURTOĞLU Alüminyum İstanbul'a yaklaşık 100 km mesafede Çorlu'da bulunmaktadır. 31.000 m² kapalı alanda faaliyetini sürdürmektedir. Son yapılan yatırımlarla şirketimiz modern bir entegre tesis haline ulaşmıştır.

Şirketimizin ana özellikleri aşağıda da belirtilmiştir:

- Yıllık kapasite ~ 34.000 ton,
- Yaklaşık ~ 400 kalifiye eleman,
- ISO 9001:2000 kalite sistemi,
- Qualicoat Belgesi,
- Qualanod Belgesi,
- CE Belgesi,
- Kalıphan Bölümü (Tel erozyon, İşleme Merkezi)
- Alüminyum Ekstrüzyon Presleri; (800 ton, 1460 ton, 1880 ton, 1460/1880 ton, 2100 ton ve 2600 ton),
- Eloksal Tesisi (91.000 Amper)
- Elektrostatik Toz Boya Tesisi
- Mekanik İşlem Bölümü (CNC İşleme Merkezi)

KURTOĞLU Alüminyum ürünleri; İsviçre, Almanya, Avusturya, Yunanistan, Kıbrıs, Bulgaristan, Libya, Ganha, Rusya Federasyonu, Ukrayna, Litvanya, Moldova, Sırbistan, Karadağ, Macaristan, İran, Irak, Ermenistan, Arnavutluk, Gürcistan, Hollanda, Çek Cumhuriyeti, İsrail, Beyaz Rusya, Azerbaycan, Türkmenistan, Tacikistan, Kırgızistan, Kazakistan, Makedonya, Romanya'ya ihraç edilmektedir.

KURTOĞLU ALÜMİNYUM müşterilerine sıfır hata ile hizmet vermeyi temel olarak çalışmalarını sürdürmektedir.

Компания "КУРТОГЛУ Алюминиум"

Наша фирма начала свою деятельность в 1960 годы с производства мели и олова. В 1980 г. компания начала производство экструзионного пресса алюминия имеющего емкость 1200 тонн.

Компания "КУРТОГЛУ Алюминиум" расположена на восточном побережье приблизительно 100 км от Стамбула в г. Чорлу. Фирма осуществляет свою деятельность на 31 000 М2 закрытой площади. Компания, благодаря новым инвестициям приобрела новое интегрированное предприятие.

Основные данные о фирме:

- * Годовая мощность - 34 000 тонн,
- * Около - 400 квалифицированных работников.
- * ISO 9001:2000 система качества,
- * Сертификат Qualicoat,
- * Сертификат Qualanod,
- * Сертификат CE,

- Отделение установки форм (Провороченая эрозия, Центр обработки)
- Экструзионные прессы для алюминия; (800 тонн, 1460 тонн, 1880 тонн, 2100 тонн, 2700 тонн)
- Цех анодного окисления (91000 ампер.)
- Цех электростатической порошковой краски
- Цех механической обработки (CNC Центр переработки)

Продукция компании "КУРТОГЛУ Алюминиум" экспортируется в такие страны, как Швейцария, Германия, Австрия, Греция, Кипр, Россия, Украина, Литва, Молдова, Сербия, Кардаг, Венгрия, Иран, Ирак, Армения, Албания, Румыния и Грузия.

Компания "КУРТОГЛУ Алюминиум" оказывает все необходимые услуги для клиентов в рамках принципа безупречности и высокого качества.

Более подробную информацию о фирме можете получить на веб-странице компании.

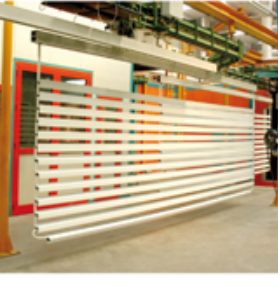

Μετάφραση από τα Τουρκικά Αργίλιο ΚΟΥΡΤΟΓΛΟΥ

Η Εταιρεία μας άρχισε τη παραγωγική της ζωή το έτος 1960 με χαλκό και με μολύβδο. Το έτος δε 1980 εισήλθε στον τομέα της παραγωγής 1200 τόνων με την πρέσα εκτρουζιόν αργιλίου.

Η Επιχείρηση ΚΟΥΡΤΟΓΛΟΥ ΑΡΓΙΛΙΟ βρίσκεται στο Τσόρλου περίπου σε απόσταση 100 χιλιάμετρα από την Ισταμπούλ. Συνεχίζει τη δραστηριότητα της σε ένα κλειστό χώρο

31.000 τετραγωνικών μέτρων και σε ανοικτό χώρο 11.000 τετραγωνικών μέτρων. Η Εταιρεία μας, με τις τελευταίες καταθέσεις που έγιναν έφθασε σε κατάσταση μιας σύγχρονης ενσωματωμένης εγκατάστασης.

Οι βασικές ιδιότητες της επιχείρησής μας αναφέρονται παρακάτω :

- Ετήσια χωρητικότητα = 34.000 τόνοι
- 400 περίπου άτομα από ειδικευμένο προσωπικό
- Σύστημα ποιότητας = ISO 9001:2000
- Πιστοποιητικό Qualicoat
- Πιστοποιητικό Qualanod
- Πιστοποιητικό CE

- Τμήμα καλουπιών (Κέντρο επεξεργασίας, διάβρωση του σύρματος)

- Πρέσες εκτρουζιόν του αργιλίου :

(800 τόνων, 1460 τόνων, 1880 τόνων, 1880 τόνων, 2100 τόνων και 2700 τόνων)

- Εγκατάσταση ελοκαάλ (91.000 Αμπέρ)

- Εγκατάσταση ηλεκτροστατικής βαφής από σκόνη

- Τμήμα μηχανικής επεξεργασίας (Κέντρο επεξεργασίας CNC)

Τα προϊόντα ΚΟΥΡΤΟΓΛΟΥ Αργίλιο εξάγονται στις εξής χώρες : Στην Ελβετία, στην Γερμανία, στην Αυστρία, στην Ελλάδα, στην Κύπρο, στην Βουλγαρία, στην ομοσπονδία της Ρωσίας, στην Ουκρανία, στη Λιθουανία, στην Μολδαβία, στην Σερβία, στο Μαυροβούνιο, στην Ουγγαρία, στην Περσία, στο Ιράκ, στην Αρμενία, στην Μακεδονία, στην Αλβανία, στην Ρουμανία και στην Γεωργία.

Η Επιχείρηση ΚΟΥΡΤΟΓΛΟΥ Αργίλιο, συνεχίζει τις εργασίες της λαμβάνοντας ως θεμέλιο να προσφέρει υπηρεσίες με μηδενικό λάθος.

Από την παρακάτω ιστοσελίδα μπορείτε να έχετε τη πρόσβαση για τις λεπτομερειακές γνώσεις σχετικά με την επιχείρησή μας.

KURTOGLU Aluminium

Societatea noastră și-a început activitatea din anul 1960 cu producția de cupru și plumb. A intrat în sectorul de aluminiu în anul 1980 prin inițierea producției la presă de extrudare cu o capacitate de 1200 de tone.

Fabrica KURTOĞLU Aluminium se află în localitatea Çorlu la o distanță de aproximativ 100 km față de Istanbul.

Activitatea se desfășoară în spații de producție cu o suprafață construită de 31.000 m². Datorită ultimelor

investiții realizate, firma KURTOĞLU Aluminium a devenit cea mai mare și mai modernă fabrică din Turcia și una dintre cele mai mari fabrici

producătoare de profile din aluminiu din Europa.

Caracteristicile relevante ale societății noastre sunt următoarele:

- Capacitatea anuală ~ 34.000 tone,
- Aproximativ ~ 400 lucrători calificați,
- Sistem de calitate ISO 9001:2000,
- Certificat Qualicoat,
- Certificat Qualanod,
- Certificat CE,
- Secția hală acoperită (centru de prelucrare)
- Prese extrudare aluminiu;
(800 tone, 1460 tone, 1880 tone, 1880 tone, 2100 tone și 2700 tone),
- Instalație de eloxare (anodizare) (91.000 Amperi)
- Instalație de vopsire electrostatică antistatică
- Secția de lucrări mecanice (Centrul de prelucrare CNC)

KURTOĞLU Aluminium realizează exporturi în țări cum ar fi: Elveția, Germania, Austria, Grecia, Cipru, Bulgaria, Rusia, Ucraina, Lituania, Moldova, Serbia, Montenegro, Ungaria, Iran, Irak, Armenia, Macedonia, Albania, România și Georgia.

KURTOĞLU ALUMINIUM își desfășoară activitatea pe baza principiului satisfacerii tuturor cerințelor clienților noștri.

În afara sistemelor de profile din aluminiu create de designeri renumiți din Italia, firma noastră vă poate oferi asistență tehnică de calitate prin specialiștii noștri, astfel încât putem extruda - la cerere - și profile noi din aluminiu.

Date suplimentare referitoare la firma noastră le puteți obține prin accesarea adresei web de mai jos.

(KURTOĞLU Alüminyum) آلومینیوم کورت اوغلی

شرکت ما در سالهای 1960 با تولید مس و سرب به فعالیت آغاز کرده است. در سال 1980 به بخش فعالیت تولیدات پرسی آلومینیوم اکستریزیون با 1200 تن وارد شده است.

(KURTOĞLU Alüminyum) آلومینیوم کورت اوغلی (KURTOĞLU Alüminyum) در نشانی تقریبی به فاصله 100 کیلومتر به استانبول و در شهر چورلو (Çorlu) به فعالیت خود ادامه میدهد این فعالیتها در فضای سرپوشیده به مساحت 31.000 مترمربع و فضای آزاد 11.000 مترمربع میباشد شرکت ما با سرمایه گذاریهای اخیر خود صاحب تاسیسات اینتگره مدرن میباشد.

صوصتبات اصلی شرکت ما بدین شرح میباشد :

- ظرفیت سالانه ~ 34.000 تن،
- کارکن کارآموده ~ تقریباً به تعداد 400 نفر
- سیستم مرغوبیت ISO 9001:2000
- گواهینامه Qualicoat،
- گواهینامه Qualanod،
- گواهینامه CE،

بخش قالبخانه (مرکز فعالیت اریزیون سیم

پرسیهای اکستریزیون آلومینیوم؛

(800 تن، 1460 تن، 1880 تن، 1880 تن، 2100 تن و 2700 تن)،

تاسیسات Elokosal 91.000 (آمپر)

تاسیسات رنگرزی پودری الکترواستاتیک

بخش عملیات مکانیکی مرکز کارکنی (CNC)

محصولات آلومینیوم کورت اوغلی (KURTOĞLU Alüminyum) به سوئیس، آلمان، اتریش، یونان، قبرس، بلغارستان، فدراسیون روسیه، اوکراین، لیتوانی، مولداوی، صربستان، مجارستان، ایران، عراق، ارمنستان، مقدونیه، آلبانی، رومانی و گرجستان صادر میگردد.

آلومینیوم کورت اوغلی (KURTOĞLU Alüminyum) به مشتریهای خود خدماتی با مرغوبیت به خطای صفر درجه عرضه میکند از نشانی web ما میتوانید به اطلاعات دقیق ما دسترسی پیدا کنید.



qualitypolicy

The company's quality policy is based upon the pillars of product quality, state-of-the-art technology, customer satisfaction, training, environmental concerns, and continuous development. Kurtoğlu always implements this policy in all of its operations and units.

kalitepolitikası

Şirketin kalite politikası ürün kalitesine, yeni teknolojilere, müşteri memnuniyetine, eğitime, çevre duyarlılığına ve sürekli gelişime dayanır. Kurtoğlu, her zaman tüm faaliyet ve birimlerinde bu politikayı uygular.

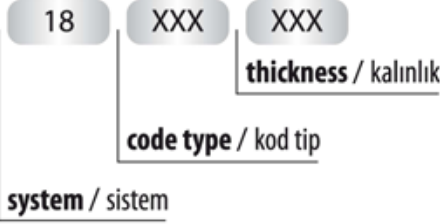

profiles / profiller**accessory / aksesuarlar****Accessory Groups / Aksesuar Grubu****LR1X-XXX Flanges / Flaşlar**

LR11-XXX External Screwed Flange / Dıştan Vidalı Flaşlar

LR12-XXX Strut Flange / Dikme Flaşı

LR13-XXX Pipe Flange / Boru Flaşı

LR14-XXX External Screwed Flange Cap Interlaced / Dıştan Vidalı Flaş Kapağı Geçmeli

LR15-XXX Special Wall Flange / Özel Duvar Flaşı

LR16-XXX 35 mm System Strut Flange / 35'lik Sistem Dikme Flaşı

LR17-XXX Decorative Flange / Dekoratif Flaş

LR2X-XXX Joints / Mafsallar

LR21-XXX Joints / Mafsallar

LR22-XXX Angled L Connection / Açılı L Bağlantı

LR3X-XXX Joints / Mafsallar

LR31-XXX Rings / Bilezikler

LR32-XXX Ceiling Clamp / Tavan Bileziği

LR4X-XXX Plugs / Tapalar

LR41-XXX Plugs / Tapalar

LR42-XXX Decorative Plugs / Dekoratif Tapalar

LR43-XXX Decorative Crystal Plugs / Dekoratif Kristal Tapalar

LR5X-XXX Glass Holders / Cam Tutucuları

LR51-XXX Pipe Glass Holder / Boru Cam Tutamağı

LR52-XXX Column Glass Holder / Dikme Cam Tutamağı

LR53-XXX Spider Glass Holder / Spider Cam Tutamağı

LR54-XXX Glass Stoper / Cam Takoza

LR6X-XXX Strut - Wall and Side Connections / Dikme - Duvar ve Yatay Bağlantılar

LR61-XXX Pipe Holder / Boru Tutamağı

LR62-XXX Interconnection / İç-Dış Bağlantı

LR63-XXX Screwable Plug / Vida Tapası

LR64-XXX Interconnection / Kurtağı

LR65-XXX Decorative Interconnection / Dekorlu Kurtağı

LR66-XXX Pipe Decorative Plug Connection / Dekorlu Tapa Bağlantı

LR67-XXX Pipe Wall Bottom Set / Duvar Dibi Takım

LR68-XXX Strut Wall Interconnection / Duvar Ara Bağlantı

LR69-XXX Lateral Interconnection / Yandan Ara Bağlantı

LR7X-XXX Traverses / Dönüşler

LR71-XXX Tube Blend / Dönüşler

LR72-XXX Sphere Bend / Küre Dönüşler

LR73-XXX Bend With Connection / Simit Bağlı Dönüşler

LR74-XXX Empty Bend / Simit Boş Takozlu Dönüşler

LR8X-XXX Anchors & Adaptors / Ankraj ve Adaptörler

LR81-XXX Anchors / Ankraj Demirleri

LR82-XXX Anchors Auxiliaries / Yardımcı Ankrajlar

LR83-XXX Door Hinge / Kapı Mentşeleri

LR84-XXX Tools / Yardımcı Malzemeler

profiles / profiller

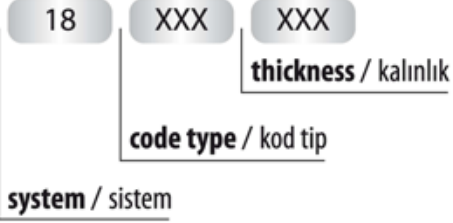

accessory/ aksesuarlar

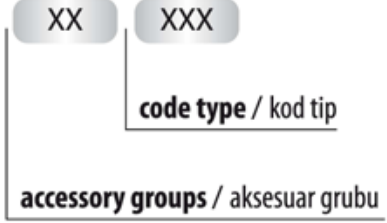

Accessory Groups / Aksesuar Grubu

LF XXX Flanges / Flanşlar

LM XXX Brackets / Mafsallar

LB XXX Pipe Rings / Bilezikler

LT XXX End Caps / Tapalar

LC XXX Glass Holders / Cam Tutucuları































LY XXX Elements For Post - Wall & Horizontal Profile Installation
Dikme - Duvar ve Yatay Bağlantı Elemanları

LS XXX Elbows / Dirsekler













LA XXX Anchors & Adaptors / Ankrajlar ve Adaptörler

accessories**index**































aksesuar**indeks**

	CODE	TÜRKÇE	ENGLISH	Русский	
	LR11-161	16'lik Dıştan Vidalı Flanş	16mm External Screwed Flange	16 мм фланец с наружным винтом	46
	LR11-301	30'lik Dıştan Vidalı Flanş	30mm External Screwed Flange	30 мм фланец с наружным винтом	46
	LR11-401	40'lik Dıştan Vidalı Flanş	40mm External Screwed Flange	40мм фланец с наружным винтом	46
	LR11-402	40'lik Dıştan Vidalı Flanş (Uzun)	40mm External Screwed Flange (Long)	40мм фланец с наружным винтом (Длинный)	46
	LR11-501	50'lik Dıştan Vidalı Flanş	50mm External Screwed Flange	50мм фланец с наружным винтом	46
	LR11-502	50'lik Dıştan Vidalı Flanş Uzun	50mm External Screwed Flange (Long)	50мм фланец с наружным винтом Длинный	46
	LR10-503	50'lik Dekoratif Flanş (Tirnaksız)	50 mm decorative flange (without pin)	Декоративный фланец 50 мм (без штифта)	46
	LR11-601	60'lik Dıştan Vidalı Flanş	60mm External Screwed Flange	60мм фланец с наружным винтом	46
	LR12-401	40'lik Dikme Flanşı	40mm Strut Flange	40 мм дисковый фланец	47
	LR12-402	40'lik Dikme Flanşı Uzun	40mm Strut Flange Long	40мм дисковый фланец (Длинный)	47
	LR12-403	40'lik Dekorlu Dikme Flanşı	Decorated Strut Flange	40 мм декоративный дисковый фланец	47
	LR12-404	40'lik Dikme Flanşı (Tek Tirnaklı)	40mm strut flange (single pin)	Фланец стойки 40 мм (с одинарным штифтом)	47
	LR12-405	40'lik Dikme Flanşı (Tirnaksız)	40mm strut flange (without pin)	Фланец стойки 40 мм (без штифта)	47
	LR12-406	40'lik Dekoratif Flanş (Tirnaksız)	40mm decorative flange (without pin)	40mm decorative flange(without Декоративный фланец 40 мм (без штифта))	47
	LR13-161	6'lik Boru Flanşı	16mm Pipe Flange	16 мм фланец трубы	47
	LR13-301	30'luk Boru Flanşı	30mm Pipe Flange	30 мм фланец трубы	47
	LR13-302	30'luk Uzun Boru Flanş	30mm Long Pipe Flange	30 мм длинный фланец трубы	48
	LR13-303	30'luk Dekorlu Boru Flanşı	30mm Decorated Pipe Flange	30 мм декорированный фланец трубы	48
	LR13-304	30'luk Boru Flanşı	30mm Pipe Flange	30 мм фланец трубы	48
	LR13-401	40'lik Boru Flanşı	40mm Pipe Flange	40 мм фланец трубы	48
	LR13-501	50'lik Boru Flanşı	50mm Pipe Flange	50 мм фланец трубы	48
	LR13-502	50'lik Boru Flanşı Uzun	50mm Pipe Flange Long	50 мм длинный фланец трубы	48
	LR13-503	40'lik Yer Dibi Flanşı	50mm flange	Напольный фланец 50 мм	48
	LR13-601	60'lik Boru Flanşı	60mm Pipe Flange	60 мм фланец трубы	48
	LR13-701	70'lik Tırtıllı Boru	70mm Perforated Pipe	70 мм зубчатый фланец	49
	LR13-702	70'lik Dekorlu Flanş	70mm Decorated Flange	70 мм декорированный фланец	49
	LR14-401	40'lik Dıştan Vidalı Flanş Kapağı Geçmeli	40mm External Screwed Flange Cap Interlaced	40 мм фланец с наружным винтом и крышкой	49
	LR14-501	50'lik Dıştan Vidalı Flanş Kapağı Geçmeli	50mm External Screwed Flange Cap Interlaced	50 мм фланец с наружным винтом и крышкой	49
	LR16-351	35'lik Sistem Dikme Flanşı	35mm system strut flange	Системный фланец для стойки 35 мм	49
	LR17-401	40'lik Dekoratif Flanş	40mm decorative flange	Декоративный фланец 40 мм	49































CODE	Ελληνικά	ROMÂNĂ	فارسی	
LR11-161	Φλάνς βιδωτό από έξω 16,ρικο	Flanșă prindere exterioră perete pentru Φ16	فلنج خارجی پیچی 16 ملی متر	46
LR11-301	Φλάνς βιδωτό από έξω 30,ρικο	Flanșă prindere exterioră perete pentru Φ 30	فلنج خارجی پیچی 30 ملی متر	46
LR11-401	Φλάνς βιδωτό από έξω 40,ρικο	Flanșă prindere exterioră perete pentru Φ 40	فلنج خارجی پیچی 40 ملی متر	46
LR11-402	Φλάνς βιδωτό από έξω 40,ρικο (Μακρύ)	Flanșă lungă prindere exterioră perete pentru Φ 40	فلنج خارجی پیچی 40 ملی متر (بلند)	46
LR11-501	Φλάνς βιδωτό από έξω 50,ρικο	Flanșă prindere exterioră perete pentru Φ 50	فلنج خارجی پیچی 50 ملی متر	46
LR11-502	Φλάνς βιδωτό από έξω 50,ρικο (Μακρύ)	Flanșă lungă prindere exterioră perete pentru Φ 50	فلنج خارجی پیچی ملی متر (بلند)	46
LR10-503	50 χλιοστά διακοσμητική φλάντζα (χωρίς pin)	Flansa decorativa pentru mana curenta Ø50 mm	(روکش پایه لوله 50 میلی متری) بدون پیچ	46
LR11-601	Φλάνς βιδωτό από έξω 60,ρικο	Flanșă prindere exterioră perete pentru Φ 60	فلنج خارجی پیچی 60 ملی متر	46
LR12-401	Φλάνς για στήσιμο 40 ρικο	Colier mascare prindere pardosea Φ 40	فلنج زائونی 40 ملی متر	47
LR12-402	Φλάνς για στήσιμο 40 ρικο (Μακρύ)	Colier mascare/innadire Φ40	فلنج زائونی 40 ملی متر دراز	47
LR12-403	Φλάνς για στήσιμο με ντεκόρ 40, ρικο	Colier decorativ mascare/innadire Φ40	فلنج لوله ای ملی متر آبکاری	47
LR12-404	40 χλιοστά αλαζονική φλάντζα (ενιαίο pin)	Colier mascare-prindere picior Ø40 mm cu pin pt. canal	(انصال پایه لوله 40 میلی متری) تک پین	47
LR12-405	40 χλιοστά αλαζονική φλάντζα (χωρίς pin)	Colier mascare-prindere picior Ø40 mm fara pin	(انصال پایه لوله 40 میلی متری) بدون پین	47
LR12-406	40 χλιοστά διακοσμητική φλάντζα (χωρίς pin)	Colier decorativ mascare-prindere picior Ø40 mm fara pin	(انصال پایه لوله 40 میلی متری) بدون پین	47
LR13-161	Φλάνς για σωλήνα 16,ρικο	Flanșă prindere perete pentru Φ16	فلنج لوله ای 16 ملی متر	47
LR13-301	Φλάνς για σωλήνα 30,ρικο	Flanșă prindere perete pentru Φ30	فلنج لوله ای 30 ملی متر	47
LR13-302	Φλάνς για μακρύ σωλήνα 30,ρικο	Colier lung mascare/imbinare pentru Φ30	فلنج لوله ای 30 ملی متر دراز	48
LR13-303	Φλάνς για σωλήνα με ντεκόρ 30,ρικο	Colier decorativ lung mascare/imbinare pentru Φ 30	فلنج لوله ای زائونی 30 ملی متر	48
LR13-304	Φλάνς για σωλήνα 30,ρικο	Flanșă prindere perete pentru Φ30	فلنج لوله ای 30 ملی متر	48
LR13-401	Φλάνς για σωλήνα 40,ρικο	Flanșă prindere interioară perete pentru Φ40	فلنج لوله ای 40 ملی متر	48
LR13-501	Φλάνς για σωλήνα 50,ρικο	Flanșă prindere interioară perete pentru Φ50	فلنج لوله ای 50 ملی متر	48
LR13-502	Φλάνς για σωλήνα 50,ρικο (Μακρύ)	Flanșă lungă prindere interioară perete pentru Φ50	فلنج لوله ای 50 ملی متر دراز	48
LR13-503	50 χλιοστά Φλάντζα δαπεδου	Flansa terminala-pardosea pt. mana curenta Ø50 mm	انصال لوله 50 میلی متری 45 درجه	48
LR13-601	Φλάνς για σωλήνα 60,ρικο	Flanșă prindere perete pentru Φ60	لوله رزوه ای یا روکش دار یا گالوانیزه 60 ملی متر	48
LR13-701	Σωλήνας με οδόντωση 70 ρικο	Colier cu model Φ70	لوله رزوه ای یا روکش دار یا گالوانیزه 70 ملی متر	49
LR13-702	Φλάνς με ντεκόρ 70 ρικος	Flanșă decorativă pentru Φ70	فلنج لوله ای 70 ملی متر آبکاری	49
LR14-401	Περαστό καπάκι του φλάνς βιδωτό από έξω 40 ρικο	Flanșă exterioră (cu capac petrecut) Φ40	درپوش فلنج با پیچ خارجی 40 ملی متر	49
LR14-501	Περαστό καπάκι του φλάνς βιδωτό από έξω 50 ρικο	Flanșă exterioră (cu capac petrecut) Φ50	درپوش فلنج با پیچ خارجی 50 ملی متر	49
LR16-351	35 χλιοστά φλάντζα συστηματος αλαζονική	Flansa cu montura pentru sistem de 35 mm	سیستم انصال پایه 35 میلی متری	49
LR17-401	40 χλιοστά διακοσμητική φλάντζα	Flansa decorativa pentru picior Ø40 mm	قطعه تزئینی پایه لوله 40 میلی متری	49

	CODE	TÜRKÇE	ENGLISH	Русский	
	LR21-351	35'lik Dikmeye 50'lik Ay Bağlantı (35x50)	50mm Crescent Connection to 35mm Strut (35 * 50)	Лунообразное крепление 50 мм для стойки 35 мм (35*50)	49
	LR21-301	30'luk Dikmeye 40'lik Ay Bağlantı (30x40)	40mm Crescent Connection to 30mm Strut (30x40)	30 мм опорное 40мм полукруглое соединение (30x40)	50
	LR21-302	30'luk Boruya 40'lik Ay Bağlantı (30x40)	40mm Crescent Connection to 30mm Pipe (30x40)	30 мм трубное 40мм круглое соединение (30x40)	50
	LR21-303	30'luk Dikmeye 50'lik Ay Bağlantı (30x50)	50mm Crescent Connection to 30mm Strut (30x50)	30 мм опорное 50мм круглое соединение (30x50)	50
	LR21-304	30'luk Boruya 50'lik Ay Bağlantı (30x50)	50mm Crescent Connection to 30mm Pipe (30x50)	30 мм трубное 50мм круглое соединение (30x50)	50
	LR21-401	40'lik Dikmeye 40'lik Ay Bağlantı (40x40)	40mm Crescent Connection to 40mm Strut (40x40)	40 мм опорное 40мм круглое соединение (40x40)	50
	LR21-402	40'lik Boruya 40'lik Ay Bağlantı (40x40)	40mm Crescent Connection to 40mm Pipe (40x40)	40 мм трубное 40мм круглое соединение (40x40)	50
	LR21-403	40'lik Dikmeye 50'lik Ay Bağlantı (40x50)	50mm Crescent Connection to 40mm Strut (40x50)	40 мм опорное 50мм круглое соединение (40x50)	50
	LR21-404	40'lik Boruya 50'lik Ay Bağlantı (40x50)	50mm Crescent Connection to 40mm Pipe (4x50)	40 мм трубное 50мм круглое соединение (40x50)	50
	LR21-501	50'lik Boruya 50'lik Ay Bağlantı (50x50)	50mm Crescent Connection to 50mm Pipe (50x 50)	50 мм трубное 5 мм круглое соединение (50x50)	51
	LR22-501	L Bağlantı	L Connection	Л Соединение	51
	LR22-502	40'lik Dikmeye 50'lik Açılı L Bağlantı	50mm Angled L Connection to 40mm Strut	40 мм опорное 50 мм угловое L соединение	51
	LR22-503	Yandan Vidalı L Bağlantı Takım	Sideway Screwed L Connection Set	Боковое винтовое L соединение-комплект	51
	LR22-504	Yandan Açılı L Bağlantı Takımı	L joint set angled from side	L-образное боковое крепление под углом в комплекте	51
	LR22-505	50'lik Boruya Duvar Küşpeşte Mafsalı	Wall bracket	Настенный шарнир поручня для трубы 50 мм	51
	LR22-401	40'lik Boruya Duvar Küşpeşte Mafsalı	Wall bracket(for 40 mm)	Настенный шарнир поручня , для трубы 40 мм	51
	LR31-161	16'lik Bilezik	16mm Ring	16 мм кольцо	51
	LR31-201	20'lik Bilezik	20mm Ring	20 мм кольцо	52
	LR31-301	30'luk Bilezik	30mm Ring	30 мм кольцо	52
	LR31-401	40'lik Bilezik	40mm Ring	40 мм кольцо	52
	LR31-501	50'lik Bilezik	50mm Ring	50 мм кольцо	52
	LR31-502	50'lik Uzun Bilezik	50mm Long Ring	50 мм длинное кольцо	52
	LR31-601	60'lik Bilezik	60mm Ring	60 мм кольцо	52
	LR32-401	40'lik Dikmeye Tavan Bileziđi	40mm Ceiling Clamp to Strut	мм опорное потолочное кольцо	52
	LR32-402	40'lik Boruya Tavan Bileziđi	40mm Ceiling Clamp to Pipe	40 мм трубное потолочное кольцо	52
	LR32-501	50'lik Tavan Bileziđi	50mm Ceiling Clamp	50 мм потолочное кольцо	53
	LR41-161	16'lik Dolu Tapası	16mm Pipe Plug 16x5mm	16 мм полная заглушка	53
	LR41-162	16'lik Boru Tapası	16mm Pipe Plug 16x2m	16 мм Заглушка для трубы	53
	LR41-201	20'lik Boru Tapası	20mm Pipe Plug	20 мм Заглушка для трубы	53
	LR41-251	25'lik Dikme Tapası	25mm strut plug	Заглушка стойки 25 мм	53
	LR41-301	30'luk Dikme Tapası	30mm Strut Plug	30 мм опорная заглушка	53

CODE	Ελληνικά	ROMÂNĂ	فارسی	
LR21-351	Κάθετη Σύνδεση 50 χιλιοστά για Ανέγερση 35 χιλιοστων (35 * 50)	Sistem prindere mana curenta Ø50 mm cupicior Ø35 (35*50)	اتصال پایه 35 میلی متری و دسته لوله 50 میلی متری	49
LR21-301	Σεληνοειδής ένωση 40 ρικια για στήσιμο 30 (30x40)	Sistem prindere picior Ø30 cu mână curentă Ø40 (30x40)	تبدیل 30 به عمودی 40 (30 * 40)	50
LR21-302	Σεληνοειδής ένωση 40 ρικια για σωλήνα 30 ρικο (30x40)	Sistem prindere picior Ø30 cu mână curentă Ø40 (30x40)	تبدیل 30 به 40 قوسی (30 * 40)	50
LR21-303	Σεληνοειδής ένωση 50 ρικια για στήσιμο 30 (30x50)	Sistem prindere picior Ø30 cu mână curentă Ø50 (30x50)	تبدیل 30 به 50 قوسی (30 * 50)	50
LR21-304	Σεληνοειδής ένωση 50 ρικια για στήσιμο 30(30x50)	Sistem prindere picior Ø30 cu mână curentă Ø50 (30x50)	تبدیل 30 به 50 قوسی (30 * 50)	50
LR21-401	Σεληνοειδής ένωση 40 ρικια για στήσιμο 40(40x40)	Sistem prindere picior Ø40 cu mână curentă Ø40 (40x40)	تبدیل 40 عمودی به قوسی 40 (40 * 40)	50
LR21-402	Σεληνοειδής ένωση 40 ρικια για στήσιμο 40 (40x40)	Sistem prindere picior Ø40 cu mână curentă Ø40 (40x40)	تبدیل لوله ای 40 به قوسی 40 (40 * 40)	50
LR21-403	Σεληνοειδής ένωση 50 ρικια για στήσιμο 40 (40x50)	Sistem prindere picior Ø40 cu mână curentă Ø50 (40x50)	تبدیل 40 عمودی به 50 قوسی (40 * 50)	50
LR21-404	Σεληνοειδής ένωση 50 ρικια για στήσιμο 40 (40x50)	Sistem prindere picior Ø40 cu mână curentă Ø50 (40x50)	تبدیل 40 لوله ای به 50 قوسی (40 * 50)	50
LR21-501	Σεληνοειδής ένωση 50 ρικια για στήσιμο 50 (50x50)	Sistem prindere picior Ø50 cu mână curentă Ø50 (50x50)	تبدیل لوله ای 50 به 50 قوسی (50 * 50)	51
LR22-501	Σύνδεση L	Prindere "L" mână curentă Ø50 - perete	رابط L	51
LR22-502	Σύνδεση L με γωνία 50 ρικια για 40 ρικο στήσιμο	Sistem prindere picior Ø40 cu prindere "L" mână curentă Ø50	رابط 50 L درجه ای با عمودی 40 ملی متر	51
LR22-503	Σετ σύνδεσης L από πλάι με βίδα.	Sistem prindere laterala cu prindere "L" mână curentă Ø50	رابط L با پیچ جانبی	51
LR22-504	Σετ Γωνιακής Σύνδεσης	Set de conectare laterala "L" cu unghi lateral	L اتصال	51
LR22-505	Αρθρώσεις στηθαίου τοίχους για σωλήνα 50 χιλιοστων	Set prindere laterala mana curenta Ø50mm - perete	اتصال دیواری	51
LR22-401	Αρθρώσεις στηθαίου τοίχους για σωλήνα 40 χιλιοστων	Set prindere laterala mana curenta Ø40 mm - perete	اتصال دیواری برای لوله 40 میلی متری	51
LR31-161	Βραχιόλι 16 ρικο	Colier cuplare/decorativ pentru Ø16	حلقه های 16 ملی متر	51
LR31-201	Βραχιόλι 20 ρικο	Colier cuplare/decorativ pentru Ø20	حلقه های 20 ملی متر	52
LR31-301	Βραχιόλι 30 ρικο	Colier cuplare/decorativ pentru Ø30	حلقه های 30 ملی متر	52
LR31-401	Βραχιόλι 40 ρικο	Colier cuplare/decorativ pentru Ø40	حلقه های 40 ملی متر	52
LR31-501	Βραχιόλι 50 ρικο	Colier cuplare/decorativ pentru Ø50	حلقه های 50 ملی متر	52
LR31-502	Βραχιόλι 50 ρικο (μακρύ)	Colier lung cuplare/decorativ pentru Ø50	حلقه های 50 ملی متر	52
LR31-601	Βραχιόλι 60 ρικο	Colier cuplare/decorativ pentru Ø60	حلقه های 60 ملی متر	52
LR32-401	Βραχιόλι της οροφής για στήσιμο 40 ρικο	Colier cuplare pentru plafon/pardosea pentru Ø40	حلقه عمودی به سقف 40 ملی متر	52
LR32-402	Βραχιόλι του σωλήνα για στήσιμο 40 ρικο	Colier cuplare pentru plafon/pardosea pentru Ø40	حلقه لوله ای به سقف 40 ملی متر	52
LR32-501	Βραχιόλι της οροφής 50 ρικο	Colier cuplare pentru plafon/pardosea pentru Ø50	حلقه سقفی 50 ملی متر	53
LR41-161	Πώμα για πλήρωση 16 ρικο	Dop capat rotunjit pentru Ø16	درپوش 16 ملی متر	53
LR41-162	Πώμα για σωλήνα 16 ρικο	Dop capat drept pentru Ø16	درپوش لوله 16 ملی متر	53
LR41-201	Πώμα για σωλήνα 20 ρικο	Dop capat rotunjit pentru Ø20	درپوش لوله 20 ملی متر	53
LR41-251	25 χιλιοστά βύσμα αλαζονικό	Dop capat pentru Ø25 mm	درپوش لوله 25 میلی متری	53
LR41-301	Πώμα για ανόρθωση 30 ρικο	Dop capat rotunjit pentru Ø30	درپوش عمودی 30 ملی متر	53

	CODE	TÜRKÇE	ENGLISH	Русский	
	LR41-302	30'luk Boru Tapası	30mm Pipe Plug	30 мм Заглушка для трубы	53
	LR41-401	40'luk Dikme Tapası	40mm Strut Plug	40 мм опорная заглушка	53
	LR41-402	40'luk Boru Tapası	40mm Pipe Plug	40 мм Заглушка для трубы	54
	LR41-501	50'luk Boru Tapası	50mm Pipe Plug	50 мм Заглушка для трубы	54
	LR41-502	50'luk Boru Tapası Ekonomik	50mm eco pipe plug	Заклушка трубы 50 мм экономич.	54
	LR41-601	60'luk Boru Tapası	60mm Pipe Plug	60 мм Заглушка для трубы	54
	LR41-651	65'luk Boru Tapası	65mm Pipe Plug	65 мм Заглушка для трубы	54
	LR42-161	16'luk Dekorlu Tapa	16mm decorative plug	Декоративная заглушка 16 мм	54
	LR42-301	30'luk Dekorlu Tapa	30mm Decorative Plug	30 мм Декоративная заглушка	54
	LR42-401	40'luk Dikme Dekorlu Tapa	40mm Strut Decorative Plug	40 мм опорная декоративная заглушка	54
	LR42-402	40'luk Boru Dekorlu Tapa	40mm Pipe Decorative Plug	40 мм трубная декоративная заглушка	55
	LR42-501	50'luk Dikme Dekorlu Tapa	50mm Strut Decorative Plug	50 мм опорная декоративная заглушка	55
	LR42-502	50'luk Boru Dekorlu Tapa	50mm Pipe Decorative Plug	50 мм трубная декоративная заглушка	55
	LR42-601	60'luk Boru Dekorlu Tapa	60mm Pipe Decorative Plug	60 мм трубная декоративная заглушка	55
	LR42-651	65'luk Dekorlu Tapa	65mm Decorative Plug	65 мм декоративная заглушка	55
	LR43-401	40'luk Dikmeye Göre Dekorlu Kristal Tapa	40mm decorative crystal plug	Декоративная кристаллическая заглушка для стойки 40 мм	55
	LR43-501	50'luk Dekorlu Kristal Tapa	50mm Decorative Crystal Plug	50 мм декоративная хрустальная заглушка	55
	LR43-601	60'luk Dekorlu Kristal Tapa	60mm Decorative Crystal Plug	60 мм декоративная хрустальная заглушка	55
	LR43-651	65'luk Dekorlu Kristal Tapa	65mm Decorative Crystal Plug	65 мм декоративная хрустальная заглушка	56
	LR44-161	16'luk Boruya Göre Dekorlu Tapa	16mm decorative plug	Декоративная заглушка для трубы 16 мм	56
	LR44-301	30'luk Boruya Göre Dekorlu Tapa	30mm decorative plug	Декоративная заглушка для трубы 30 мм	56
	LR51-301	30'luk Boru Cam Tutamağı	30mm Pipe Glass Holder	30 мм трубный стеклодержатель	56
	LR51-401	40'luk Boru Cam Tutamağı	40mm Pipe Glass Holder	40 мм трубный стеклодержатель	56
	LR51-402	40'luk Dikme Cam Tutamağı	40mm Strut Glass Holder	40 мм опорный стеклодержатель	56
	LR51-403	40'luk Boruya Vidalı Cam Tutamağı	40mm Pipe Screwed Glass Holder	40 мм трубным винтовым соединением- стеклодержатель	56
	LR51-404	40'luk Dikme Vidalı Cam Tutamağı	40mm Strut Screwed Glass Holder	40 мм опорным винтовым соединением- стеклодержатель	56
	LR51-405	40'luk Yandan Vidalı Cam Tutamağı	40mm Pipe Sideway Screwed Glass Holder	40 мм боковой винтовый стеклодержатель	57
	LR51-406	40'luk Dikme Arası Cam Tutucu	40mm Strut Glass Holder	40 мм стеклодержатель между опорами	57
	LR51-407	40'luk Boruya Ayarlı Cam Tutamağı	40mm pipe adjustable glass holder	Стекольный штапик, регулируемый для трубы 40 мм	57
	LR51-408	40'luk Dikmeye Ayarlı Cam Tutamağı	40mm strut adjustable glass holder	Стекольный штапик, регулируемый для стойки 40 мм	57
	LR52-401	40'luk Tekli Cam Tutamağı	40mm Single Glass Holder	40 мм одинарный стеклодержатель	57







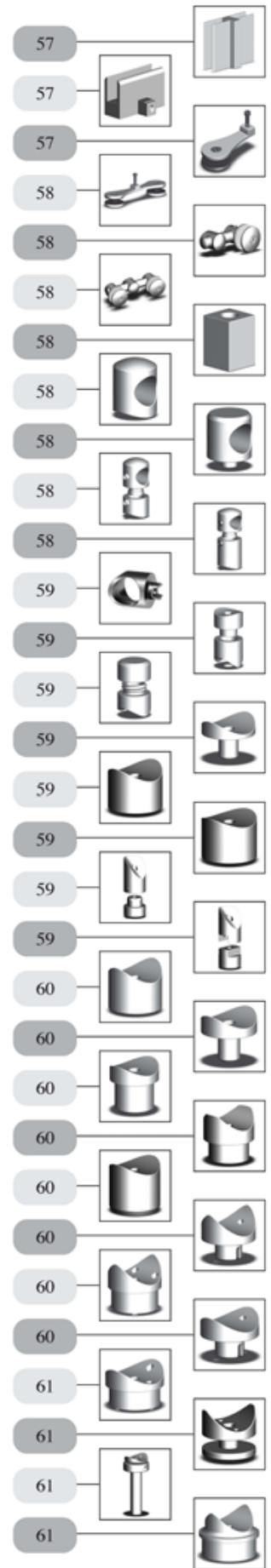























CODE	Ελληνικά	ROMÂNĂ	
LR41-302	Πώμα για σωλήνα 30.ρικο	Dop capat rotunjit pentru Ø30	درپوش لوله 30 ملی متر
LR41-401	Πώμα για ανόρθωση 40.ρικο	Dop capat rotunjit pentru Ø40	درپوش عمودی 40 ملی متر
LR41-402	Πώμα για σωλήνα 40.ρικο	Dop capat rotunjit pentru Ø40	درپوش لوله 40 ملی متر
LR41-501	Πώμα για σωλήνα 50.ρικο	Dop capat rotunjit pentru Ø50	درپوش لوله 50 ملی متر
LR41-502	50 χιλιοστά βύσμα σωλήνα οικονομικό	Dop capat pentru mana curenta Ø50 mm	درپوش لوله 50 میلی متری
LR41-601	Πώμα για σωλήνα 60.ρικο	Dop capat rotunjit pentru Ø60	درپوش لوله 60 ملی متر
LR41-651	Πώμα για σωλήνα 65.ρικο	Dop capat rotunjit pentru Ø65	درپوش لوله 65 ملی متر
LR42-161	16 χιλιοστά διακοσμητικό βύσμα	Dop decorativ capat pentru traversa Ø16 mm	درپوش تزیینی لوله 16 میلی متری
LR42-301	Πώμα με ντεκόρ 30.ρικο	Dop capat decorativ pentru Ø30	درپوش لوله گالوانیزه 30 ملی متر
LR42-401	Πώμα με ντεκόρ για ανόρθωση 40.ρικο	Dop capat decorativ pentru Ø40	درپوش لوله عمودی گالوانیزه 40 ملی متر
LR42-402	Πώμα με ντεκόρ για σωλήνα 40.ρικο	Dop capat decorativ pentru Ø40	درپوش لوله گالوانیزه 40 ملی متر
LR42-501	Πώμα με ντεκόρ για ανόρθωση 50.ρικο	Dop capat decorativ pentru Ø50	درپوش لوله عمودی گالوانیزه 50 ملی متر
LR42-502	Πώμα με ντεκόρ για σωλήνα 50.ρικο	Dop capat decorativ pentru Ø50	درپوش لوله گالوانیزه 50 ملی متر
LR42-601	Πώμα με ντεκόρ για σωλήνα 60.ρικο	Dop capat decorativ pentru Ø60	درپوش لوله گالوانیزه 60 ملی متر
LR42-651	Πώμα με ντεκόρ 65.ρικο	Dop capat decorativ pentru Ø65	درپوش لوله گالوانیزه 65 ملی متر
LR43-401	Διακοσμητικό αλαζονικό βύσμα κρυσταλλίνο 40 χιλιοστά	Dop decorativ din cristal capat pentru Ø40 mm	درپوش تزیینی کریستال لوله 40 میلی متری
LR43-501	Κρυσταλλένιο πώμα με ντεκόρ 50.ρικο	Dop capat decorativ din cristal pentru Ø50	درپوش لوله کریستال 50 ملی متر
LR43-601	Κρυσταλλένιο πώμα με ντεκόρ 60.ρικο	Dop capat decorativ din cristal pentru Ø60	درپوش لوله کالوانیزه 60 ملی متر
LR43-651	Κρυσταλλένιο πώμα με ντεκόρ 65.ρικο	Dop capat decorativ din cristal pentru Ø65	درپوش لوله کالوانیزه 65 ملی متر
LR44-161	Διακοσμητικό βύσμα για σωλήνα 16 χιλιοστά	Dop decorativ capat pentru traversa Ø16 mm	درپوش تزیینی لوله 16 میلی متری
LR44-301	Διακοσμητικό βύσμα για σωλήνα 30 χιλιοστά	Dop decorativ capat pentru Ø30 mm	درپوش تزیینی لوله 30 میلی متری
LR51-301	Κράτημα του τζαμιού του 30 ρικου σωλήνα	Suport geam pentru Ø30	زوار یا گیره شیشه 30 ملی متر
LR51-401	Κράτημα του τζαμιού του 40. ρικου σωλήνα	Suport geam pentru Ø40	زوار یا گیره شیشه 40 ملی متر
LR51-402	Κράτημα του τζαμιού της 40 ρικης ανόρθωσης	Suport geam cu ghidaj pentru Ø40	زوار یا گیره عمودی شیشه 40 ملی متر
LR51-403	Κράτημα του τζαμιού με βίδα σε 40 ρικο σωλήνα	Suport cu prindere geam pentru Ø40	زوار یا گیره شیشه پیچ دار 40 ملی متر
LR51-404	Κράτημα του τζαμιού με βίδα σε 40 ρικα ανόρθωση.	Suport cu ghidaj - prindere geam pentru Ø40	زوار یا گیره عمودی شیشه 40 ملی متر
LR51-405	Κράτημα του τζαμιού με βίδα από το πλάι 40 ρικο	Suport cu ghidaj - prindere geam pentru Ø40	زوار یا گیره شیشه 40 ملی متر
LR51-406	Κράτημα του τζαμιού ενδιάμεσο στην ανόρθωση 40.ρικο	Suport geam pentru Ø40	زوار یا گیره عمودی شیشه 40 ملی متر
LR51-407	Ρυθμιζόμενη λαβή γυαλιού για σωλήνα 40 χιλιοστά	Suport geam ajustabil pentru picior Ø40 mm	قطعه اتصال شیشه و لوله 40 میلی متری
LR51-408	40 χιλιοστά αλαζονική ρυθμιζόμενη λαβή γυαλιού	Suport geam ajustabil cu picioruse pentru canal picior Ø40 mm	قطعه اتصال شیشه و لوله شمار دار 40 میلی متری
LR52-401	Κράτημα του τζαμιού μονό 40.ρικο	Suport lateral geam pentru Ø40	زوار یا گیره تکي شیشه 40 ملی متر

































	CODE	TÜRKÇE	ENGLISH	Русский	
	LR52-402	40'lık Çiftli Cam Tutamağı	40mm Double Glass Holder	40 мм двойной стеклодержатель	57
	LR52-403	40'lık Dikme Cam Tutamağı	40mm strut glass holder	Стеклоный штапик, регулируемый для трубы 40 мм	57
	LR53-401	40'lık Tekli Spider Cam Tutamağı	40mm Single Spider Glass Holder	40мм одинарный Spider стеклодержатель	57
	LR53-402	40'lık Çiftli Spider Cam Tutamağı	40mm Double Spider Glass Holder	40мм двойной Spider стеклодержатель	58
	LR53-403	40'lık Tekli Spider Cam Tutamağı	40mm strut glass holder	Стеклоный штапик, регулируемый для трубы 40 мм	58
	LR53-404	40'lık Çiftli Spider Cam Tutamağı	40mm double Spider Glass Holder	Стеклоный штапик "Spider" двойной 40 мм	58
	LR54-401	Cam Takozu	Glass Stopper	Клин для стекла	58
	LR61-161	16'lık Tutamak Kurt Ağızlı	16mm Pipe Holder	16мм Держатель "пасточкин хвост"	58
	LR61-162	16'lık Tutamak	16mm Pipe Holder	16мм Держатель	58
	LR61-163	16'lık Tutamak Çiftli	16mm Double Holder	16мм Двойной держатель	58
	LR61-164	16'lık Tutamak Çiftli (Uzun)	16mm Double Holder (Long)	16мм Двойной держатель (Длинный)	58
	LR61-165	16'lık Tutamak	16mm Pipe Holder	Стеклоный штапик "Spider" двойной 40 мм	59
	LR62-161	16'lık İç Dış Bağlantı	16mm Interconnection	16мм Внутреннее и наружное соединение	59
	LR63-161	16'lık Vida Tapası	16mm Screwable Plug	16мм заглушка для винта	59
	LR64-161	16'lık Boruya Göre 30'lık Kurtağzı (16x30)	16mm Pipe Interconnection to 30mm Pipe (16 x30)	16мм трубный 30мм "ласточкин хвост" (16x30)	59
	LR64-162	16'lık Boruya Göre 30'luk Kurtağzı (16x30)	30mm interconnection for 16mm pipe (16*30)	Крепление "ласточкин хвост" 30 мм для трубы 16 мм (16 * 30)	59
	LR64-163	16'lık Boruya Göre 40'luk Kurtağzı (16x40)	40 χλιοστά διασύνδεση για σωλήνα 16 χλιοστά (16 * 40)	Крепление "ласточкин хвост" 40 мм для трубы 16 мм (16 * 40)	59
	LR64-164	16'lık Boruya Göre 30'luk Kurtağzı (16x30)	30mm interconnection for 16mm pipe (16*30)	Крепление "ласточкин хвост" 30 мм для трубы 16 мм (16 * 30)	59
	LR64-165	16'lık Boruya Göre 30'luk Kurtağzı (16x30)	30mm interconnection for 16mm pipe (16*30)	Крепление "ласточкин хвост" 30 мм для трубы 16 мм (16 * 30)	59
	LR64-301	30'luk Boruya Göre 40'lık Kurtağzı (30x40)	30mm Pipe Interconnection to 40mm Pipe (30x40)	30мм трубный 40мм "ласточкин хвост" (30 x40)	60
	LR64-302	30'luk Dikmeye Göre 40'lık Kurtağzı (30x40)	0mm Strut Interconnection to 40mm Pipe (30x40)	30мм Опорная часть 40мм "ласточкин хвост" (30 x40)	60
	LR64-303	30'luk Boruya Göre 50'lık Kurtağzı (30x50)	30mm Pipe interconnection to 50mm Pipe (30x50)	30мм трубный 50 мм "ласточкин хвост" (30 x50)	60
	LR64-304	30'luk Boruya Göre 30'luk Kurtağzı (30x30)	30mm interconnection for 30mm pipe (30*30)	Крепление "ласточкин хвост" 30 мм для трубы 30 мм (30 * 30)	60
	LR64-305	30'luk Boruya Göre 50'luk Kurtağzı (30x50)	50mm interconnection for 30mm pipe (30*50)	Крепление "ласточкин хвост" 50 мм для трубы 30 мм (30 * 50)	60
	LR64-401	40'lık Dikmeye Göre 40'lık Kurtağzı (40x40)	40mm Strut Interconnection to 40mm strut (40x40)	40мм Опорная часть 40мм "ласточкин хвост" (40x40)	60
	LR64-402	40'lık Boruya Göre 40'lık Kurtağzı (40x40)	40mm Pipe Interconnection to 40mm Pipe (40x40)	40мм трубный 40 мм "ласточкин хвост" (40 x40)	60
	LR64-403	40'lık Dikmeye Göre 50'lik Kurtağzı (40x50)	40mm Strut Interconnection to 50mm Pipe (40x50)	40мм Опорная часть 50мм "ласточкин хвост" (40x50)	60
	LR64-404	40'lık Boruya Göre 50'lik Kurtağzı (40x50)	40mm Pipe Interconnection to 50mm Pipe (40x50)	40мм трубный 50мм "ласточкин хвост" (40x50)	61
	LR64-405	40'lık Boruya Göre 40'lık Kurtağzı (40x40)	40mm interconnection for 40mm pipe (40*40)	Крепление "ласточкин хвост" 40 мм для трубы 40 мм (40 * 40)	61
	LR64-406	40'lık Dikmeye Göre 50'lik Ayarlı Kurtağzı (40x50)	50mm interconnection for 40mm strut (40*50)	Крепление "ласточкин хвост" 50 мм для стойки 40 мм (40 * 50)	61
	LR64-501	50'lık Boruya Göre 40'lık Kurtağzı (50x40)	50mm Pipe Interconnection to 40mm Pipe (50x40)	50мм трубный 40мм "ласточкин хвост" (50 40)	61

































CODE	Ελληνικά	ROMÂNĂ	فارسی
LR52-402	Κράτημα του τζαμιού διπλό 40,ρικο	Support dublu lateral geam pentru Ø40	زوار یا گیره زوجی شیشه 40 ملی متر
LR52-403	40 χιλιοστά αλαζονική λαβή γυαλιού	Support geam pentru picior Ø40 mm	قطعه اتصال شیشه و لوله بشیار دار 40 میلی متری
LR53-401	Κράτημα του τζαμιού μονό σπίντερ 40,ρικο	Support Spider geam pentru Ø40	زوار یا گیره تک اسپیدر شیشه 40 ملی متر
LR53-402	Κράτημα του τζαμιού διπλό σπίντερ 40,ρικο	Support dublu Spider geam pentru Ø40	زوار یا گیره زوجی اسپیدر شیشه 40 ملی متر
LR53-403	40 χιλιοστά ενιαία λαβή γυαλιού	Support simplu geam Spider pentru picior Ø40 mm	قطعه اتصال تک شیشه و لوله 40 میلی متری
LR53-404	40 χιλιοστά διπλή λαβή γυαλιού	Support dublu geam Spider pentru picior Ø40 mm	قطعه اتصال دوپل شیشه و لوله 40 میلی متری
LR54-401	Ξύλινο βύσμα (τάκος)του τζαμιού	Stoper geam	تکیه گاه شیشه
LR61-161	Χειρολαβή 16 ρικια με στόμα λύκου	Prindere - suport traversa Ø16	تکیه گاه شیشه 16 ملی متر
LR61-162	Χειρολαβή 16 ρικια	Prindere - suport traversa Ø16	تکیه گاه شیشه 16 ملی متر
LR61-163	Χειρολαβή 16 ρικια διπλή	Prindere dublă - suport traversa Ø16	تکیه گاه شیشه 16 ملی متر زوجی
LR61-164	Χειρολαβή 16 ρικια διπλή-μακριά	Prindere lungă - suport traversa Ø16	تکیه گاه شیشه 16 ملی متر زوجی (بلند)
LR61-165	Χειρολαβή 16 ρικια	Prindere-suport pentru traversa Ø16 mm	قطعه نگهدارند پروفیل 16 میلی متری
LR62-161	Εσωτερική και εξωτερική σύνδεση 16, ρικια	Cuplaj interior/exterior Ø16	رابطه های داخلی و خارجی 16 ملی متر
LR63-161	Πώμα της βίδας 16, ρικο	Cuplaj cu filet pentru Ø16	درپوش پیچ 16 ملی متر
LR64-161	30 ρικο στόμα του λύκου για 16 ρικο σωλήνα (16x30)	Piesă îmbinare Ø16 pentru țevă Ø30 (16x30)	تبدیل 16 به 30 (16*30)
LR64-162	30 χιλιοστά διασύνδεση για σωλήνα 16 χιλιοστά (16 * 30)	Prindere-suport traversa Ø16 mm pentru picior Ø30 (16x30)	انصال میانی لوله 30 میلی متری و 16 میلی متری
LR64-163	40 χιλιοστά διασύνδεση για σωλήνα 16 χιλιοστά (16 * 40)	Prindere-suport traversa Ø16 mm pentru picior 430 (16x30)	انصال میانی لوله 40 میلی متری و 16 میلی متری
LR64-164	30 χιλιοστά διασύνδεση για σωλήνα 16 χιλιοστά (16 * 30)	Prindere-suport traversa Ø16 mm pentru picior Ø30 mm cu prindere exterioara (16x30)	انصال میانی لوله 30 میلی متری و 16 میلی متری
LR64-165	30 χιλιοστά διασύνδεση για σωλήνα 16 χιλιοστά (16 * 30)	Prindere-suport traversa Ø16 mm pentru picior Ø30 mm cu prindere exterioara canal (16*30)	انصال میانی لوله 30 میلی متری و 16 میلی متری
LR64-301	40, ρικο στόμα του λύκου για 30, ρικο σωλήνα (30x40)	Piesă îmbinare Ø30 pentru țevă Ø40 (30x40)	تبدیل لوله 30 به 40 (30*40)
LR64-302	40, ρικο στόμα του λύκου για 30 ρικη αν όρθωση (30x40)	Piesă îmbinare Ø30 pentru țevă Ø40 (30x40)	تبدیل عمودی 30 به 40 (30*40)
LR64-303	50 ρικο στόμα του λύκου για 30 ρικο σωλήνα (30x50)	Piesă îmbinare Ø30 pentru țevă Ø50 (30x50)	تبدیل لوله 30 به 50 (30 * 50)
LR64-304	30 χιλιοστά διασύνδεση για σωλήνα 30 χιλιοστά (30 * 30)	Piesa conectoare Ø30 mm cu Ø30 mm (30*30)	انصال میانی لوله 30 میلی متری و 30 میلی متری
LR64-305	50 χιλιοστά διασύνδεση για σωλήνα 30 χιλιοστά (30 * 50)	Piesa conectoare Ø50 mm cu Ø30 mm (30*50)	انصال میانی لوله 50 میلی متری و 30 میلی متری
LR64-401	40 ρικο στόμα του λύκου για 40 ρικη ανόρθωση (40x40)	Piesă îmbinare Ø40 pentru țevă Ø40 (40x40)	تبدیل عمودی 40 به 40 (40 * 40)
LR64-402	40, ρικο στόμα του λύκου για 40 ρικο σωλήνα (40x40)	Piesă îmbinare Ø40 pentru țevă Ø40 (40x40)	تبدیل لوله 40 به 40 (40 * 40)
LR64-403	50,ρικο στόμα του λύκου για 40 ρικη ανόρθωση (40x50)	Piesă îmbinare Ø40 pentru țevă Ø50 (40x50)	تبدیل عمودی 40 به 50 (40*50)
LR64-404	50 ρικο στόμα του λύκου για 40 ρικο σωλήνα (40x50)	Piesă îmbinare Ø40 pentru țevă Ø50 (40x50)	تبدیل لوله 40 به 50 (40*50)
LR64-405	40 χιλιοστά διασύνδεση για σωλήνα 40 χιλιοστά (40 * 40)	Piesa conectoare Ø40 mm cu Ø40 mm (40*40)	انصال میانی لوله 40 میلی متری و 40 میلی متری
LR64-406	50 χιλιοστά διασύνδεση για 40 χιλιοστά αλαζονικό (40 * 50)	Piesa interconectare de 50 mm pentru montura de 40 mm (40*50)	انصال میانی لوله 50 میلی متری و 40 میلی متری
LR64-501	40, ρικο στόμα του λύκου για 50, ρικο σωλήνα (50x40)	Piesă îmbinare Ø40 pentru țevă Ø50 (40x50)	تبدیل لوله 40 به 50 (50 * 40)



































	CODE	TÜRKÇE	ENGLISH	Русский	
	LR64-502	50'lik Dikmeye Göre 40'lik Kurtağzı (50x40)	50mm Strut Interconnection to 40mm Pipe (50x40)	50мм Опорная часть 40мм "ласточкин хвост" (50 x40)	61
	LR64-503	50'lik Boruya Göre 50'lik Kurtağzı (50x50)	50mm Pipe Interconnection to 50mm Pipe (50x50)	50мм Трубная 50 мм "ласточкин хвост" (50x50)	61
	LR65-301	30'lik Dikmeye Göre 50'lik Dekorlu Kurtağzı (30x50)	30mm Strut Decorative Interconnection to 50mm Pipe (30x50)	30мм Опорная часть 50 мм Декоративный "ласточкин хвост" (30 x50)	61
	LR65-351	35'lik Sistem 35'lik Boruya Göre 50'lik Dekorlu Kurtağzı (35x50)	50mm decorative interconnection for 35mm pipe (35*50)	Декоративное крепление "ласточкин хвост" 50 мм для трубы 35 мм системы 35 мм (35 * 50)	61
	LR65-401	40'lik Dikmeye Göre 50'lik Dekorlu Kurtağzı (40x50)	40mm Strut Decorative Interconnection to 50mm Pipe (40x50)	40мм Опорная часть 50 мм Декоративный "ласточкин хвост" (40 x50)	62
	LR65-402	40'lik Dikmeye Göre 50'lik Dekorlu Kurtağzı Uzun (40x50)	40mm Strut Decorative Interconnection long to 50mm Pipe (40x50)	40мм Опорная часть 50 мм Декоративный "ласточкин хвост" длинный(40 x50)	62
	LR66-501	50'lik Dekorlu Tapa Bağlantısı	50mm Pipe Decorative Plug Connection	50мм Декоративное соединение заглушки	62
	LR66-601	60'lik Dekorlu Tapa Bağlantısı	60mm Pipe Decorative Plug Connection	60мм Декоративное соединение заглушки	62
	LR66-651	65'lik Dekorlu Tapa Bağlantısı	65mm Pipe Decorative Plug Connection	65мм Декоративное соединение заглушки	62
	LR67-501	50'lik Duvar Dibi Takım	50mm Pipe Wall Bottom Set	50мм Комплект для нижней части стены	62
	LR67-502	50'lik Boruya Göre Duvar Dibi Takım	50mm Pipe Wall Bottom Set	Комплект пристенный для трубы 50 мм	62
	LR68-301	30'lik Dikmeye Duvar Ara Bağlantı	30mm Strut Wall Interconnection	30мм Опорное настенное среднее соединение	62
	LR68-401	40'lik Dikmeye Duvar Ara Bağlantı	40mm Strut Wall Interconnection	40мм Опорное настенное среднее соединение	63
	LR68-402	40'lik Dikme Yandan Özel Ara Bağlantı	40mm Strut Sideway Special Interconnection	40мм опорное боковое специальное соединение	63
	LR68-501	50'lik Dikmeye Duvar Ara Bağlantı	50mm strut Wall interconnection	50мм опорное настенное среднее соединение	63
	LR69-301	30'lik Yandan Ara Bağlantı	30mm Lateral interconnection	30мм Боковое среднее соединение	63
	LR69-401	40'lik Yandan Ara Bağlantı	40mm Lateral interconnection	40мм Боковое среднее соединение	63
	LR69-501	50'lik Yandan Ara Bağlantı	50mm Lateral interconnection	50мм Боковое среднее соединение	63
	LR69-502	Duvar Pulu	Wall Washer	Настенная гайка	63
	LR69-251	25'lik Çiftli Askı	25mm dual hanger	Двойные подвески 25 мм	63
	LR69-351	30'lik Tekli Askı	30mm single hanger	Одинарные подвески 30 мм	64
	LR71-161	16 'lik Dirsek 90°	16mm Pipe 90° Tube Bend	16 мм Опора 90°	64
	LR71-162	16 'lik Dirsek 135°	16mm Pipe 135° Tube Bend	16 мм Опора 135°	64
	LR71-163	16'lik Dirsek 30°	16mm elbow 30°	Колено 30° 16 мм	64
	LR71-164	16'lik Dekorlu Emniyet Profili	16mm decorative security profile	Предохранительный декоративный профиль 16 мм	64
	LR71-501	50'lik Dirsek 90°	50mm elbow 90°	Колено 90° 50 мм	64
	LR72-161	16 'lik Küre Dirsek	16mm Sphere Bend	16 мм Шаровая Опора	64
	LR72-162	16'lik Küre 40'lik Boruya Göre Bağlantı	16mm ball coener joint for 40mm pipe	Крепление сферическое 16 мм для трубы 40 мм	64
	LR72-301	30'lik Küre Dirsek	30mm Sphere Bend	30 мм Шаровая Опора	65
	LR72-401	40'lik Bilezikli Küre Dirsek	40mm Sphere Bend	40мм Шаровая опора с кольцом	65
	LR72-501	50'lik Bilezikli Küre Dirsek	50mm Sphere Bend	50мм Шаровая опора с кольцом	65































CODE	Ελληνικά	ROMÂNĂ	فارسی	
LR64-502	40 ρικο στόμα του λάκου για 50 ρικια ανόρθωση (50x40)	Piesă îmbinare Φ40 pentru țevă Φ50 (40x50)	تبدیل عمودی 40 به 50 (40 * 50)	61 
LR64-503	50 ρικο στόμα του λάκου για 50 ρικια σωλήνα (50x50)	Piesă îmbinare Φ50 pentru țevă Φ50 (50x50)	تبدیل لوله 50 به 50 (50 * 50)	61 
LR-65-301	50 ρικο στόμα του λάκου με νεκρό άκρωνα με 30 ρικια ανόρθωση (30x50)	Piesă decorativă îmbinare Φ50 pentru țevă Φ30 (50x30)	تبدیل لوله 30 به 50 دکوری (30 * 50)	61 
LR65-351	Συστημα 35 χλιοστά 50 χλιοστά διακοσμησηκ διασύνδεση για 35 χλιοστά σωλήνα (35 * 50)	Piesa decorativa conectoare Ø50 mm cu Ø35 mm (40*50)	انصال مابى تزئينى لوله 50 مېلى مترى و 35 مېلى مترى	61 
LR65-401	50 ρικο στόμα του λάκου με νεκρό για 40 ρικια ανόρθωση (40x50)	Piesă decorativă îmbinare Φ40 pentru țevă Φ50 (40x50)	تبدیل لوله 40 به 50 دکورى (40 * 50)	62 
LR65-402	50 ρικο στόμα του λάκου με νεκρό για 40 ρικια ανόρθωση (40x50) MARKY	Piesă decorativă îmbinare Φ40 pentru țevă de Φ50 (40x50)	تبدیل لوله 40 به 50 دکورى دراز (40 * 50)	62 
LR66-501	Σύνδεση πάματος νε νεκρό 50 ρικια	Conector pentru Φ50	رابطه درپوش دکورى 50 ملى متر	62 
LR66-601	Σύνδεση πάματος με νεκρό 60 ρικια	Conector pentru Φ60	رابطه درپوش دکورى 60 ملى متر	62 
LR66-651	Σύνδεση πάματος με νεκρό 65 ρικια	Conector pentru Φ65	رابطه درپوش دکورى 65 ملى متر	62 
LR67-501	Σετ για βαση του τοίχου 50 ρικο	Sistem prindere laterală perete pentru Φ50	جهاز 50 ملى متر ديوارى	62 
LR67-502	Σετ διασύνδεσης δαπεδου για σωλήνα 50 χλιοστά	Set prindere laterala mana curenta Ø50 mm - perete	انصال ديوارى لوله 50 مېلى مترى	62 
LR68-301	Ενδιάμεση σύνδεση τοίχου για ανόρθωση 30 ρικια	Distantier cuplare laterală perete pentru Φ30	رابطه 30 ملى متر عمودى ديوار	62 
LR68-401	Ενδιάμεση σύνδεση τοίχου για ανόρθωση 40 ρικια	Distantier cuplare laterală perete pentru Φ40	رابطه 40 ملى متر عمودى ديوار	63 
LR68-402	Ιδιαίτερη ενδιάμεση σύνδεση από τα πλάγια για ανόρθωση 40 ρικια	Cuplaj intermediar special pentru prindere laterală Φ40	رابطه مخصوص 40 ملى متر عمودى ديوار	63 
LR68-501	Ενδιάμεση σύνδεση τοίχου για ανόρθωση 50 ρικια	Sistem prindere laterală perete pentru Φ50	رابطه 50 ملى متر عمودى ديوار	63 
LR69-301	Ενδιάμεση σύνδεση από τα πλάγια 30 ρικια	Cuplaj intermediar lateral Φ30	رابطه ما بين 30 ملى متر جانبى	63 
LR69-401	Ενδιάμεση σύνδεση από τα πλάγια 40 ρικια	Cuplaj intermediar lateral Φ40	رابطه ما بين 40 ملى متر جانبى	63 
LR69-501	Ενδιάμεση σύνδεση από τα πλάγια 50 ρικια	Cuplaj intermediar lateral Φ50	رابطه ما بين 50 ملى متر جانبى	63 
LR69-502	Ροδέλα του τοίχου	Flanșă mascare prindere perete	زده و واشر ديوار	63 
LR69-251	Διπλή κρεμάστρα 25 χλιοστά	Prindere dubla-suport pentru traversa Ø25 mm	نگهدارنده دوپل لوله 25 مېلى مترى	63 
LR69-301	Μονη κρεμάστρα 30 χλιοστά	Prindere-suport pentru traversa Ø30 mm	نگهدارنده تک لوله 30 مېلى مترى	64 
LR71-161	Καμπυλωτός σωλήνας 16 ρικιας 90°	Cot de 90° pentru Φ16	زانوى 16 ملى متر 90 درجه	64 
LR71-162	Καμπυλωτός σωλήνας 16 ρικιας 135°	Cot de 135° pentru Φ16	زانوى 16 ملى متر 135 درجه	64 
LR71-163	16 χλιοστά αγκώνας 30 °	Cot traversa Ø16 mm la 30°	زانوى 30 درجه لوله 16 مېلى مترى	64 
LR71-164	16 χλιοστά διακοσμησηκ προφιλ ασφαλειας	Cot decorativ traversa Ø16 mm pentru securitate	پروفيل 16 مېلى مترى تزئينى	64 
LR71-501	50 χλιοστά αγκώνας 90 °	Cot mana curenta Ø50 mm la 90°	زانوى 90 درجه لوله 50 مېلى مترى	64 
LR72-161	Καμπυλωτός σωλήνας σφαιρικός 16 ρικιας	Cot schimbare unghi variabil pentru Φ16	زانوى 16 ملى متر توپى حلقه اى	64 
LR72-162	16 χλιοστά σφαιρική άρθρωση για σωλήνα 40 χλιοστά	Cot unghi variabil traversa Ø16 mm pentru picior Ø40 mm	انصال قابل تنظيم لوله 16 مېلى مترى و 40 مېلى مترى	64 
LR72-301	Καμπυλωτός σωλήνας σφαιρικός 30 ρικιας	Cot schimbare unghi variabil pentru Φ30	زانوى 30 ملى متر توپى حلقه اى كروى	65 
LR72-401	Καμπυλωτός σωλήνας σφαιρικός με βραχόλι 40 ρικιας	Cot unghi variabil Ø40 mm	زانوى 40 ملى متر توپى حلقه اى	65 
LR72-501	Καμπυλωτός σωλήνας σφαιρικός με βραχόλι 50 ρικιας	Cot schimbare unghi variabil pentru Φ50	زانوى 50 ملى متر توپى حلقه اى	65 

	CODE	TÜRKÇE	ENGLISH	Русский	
	LR72-502	50'lik Mafsallı Küre Dirsek	50mm Sphere Bent with joint	50мм Шаровая опора с шарниром	65
	LR72-503	50'lik Fransız Balkon Küre	Adjustable wall flange for 50mm pipe	Сферическое крепление для французского балкона 50 мм	65
	LR72-601	60'lik Küre Dirsek	60mm Sphere Bend	60мм Круглая опора	65
	LR73-301	30'luk 1/8 Simit Bağlı	30mm 1/8 Bend with Connection	30мм 1/8 Кольцевое соединение	65
	LR73-401	40'lik 1/4 Simit Bağlı	40mm 1/4 Bend with connection	40мм 1/4 Кольцевое соединение	65
	LR73-402	40'lik 1/8 Simit Bağlı	40mm 1/8 Bend with connection	40мм 1/8 Кольцевое соединение	66
	LR73-501	50'lik 1/4 Simit Bağlı	50mm 1/4 Bend with connection	50мм 1/4 Кольцевое соединение	66
	LR73-502	50'lik 1/8 Simit Bağlı	50mm 1/8 Bend	50мм 1/8 Кольцевое соединение	66
	LR73-601	60'lik 1/4 Simit Bağlı	60mm 1/4 Bend	60мм 1/4 Кольцевое соединение	66
	LR73-602	60'lik 1/8 Simit Bağlı	60mm 1/8 Bend	60мм 1/8 Кольцевое соединение	66
	LR74-501	50'lik 1/8 Simit Boş Takozlu	50mm 1/8 Empty Bend	50мм 1/8 кольцо с пустым клином	66
	LR74-502	50'lik 1/4 Simit Boş Takozlu	50mm 1/4 Empty Bend	50мм 1/4 кольцо с пустым клином	66
	LR74-503	50'lik 1/8 Simit Boş Bilezikli	45° adjustable elbow with adapters for 50 mm	Патрубок 1/8 50 мм с переходником	66
	LR74-504	50'lik 1/4 Simit Boş Bilezikli	90° adjustable elbow with adapters for 50 mm	Патрубок 1/4 50 мм с переходником	67
	LR81-301	30'luk Ankraj Demiri	30mm Strut Anchor	30мм анкерное железо	67
	LR81-401	40'lik Ankraj Demiri 14 cm	40mm Strut anchor 14 cm	40мм анкерное железо 14 см	67
	LR81-402	40'lik Ankraj Demiri 24 cm	40mm Strut Anchor 24 cm	40мм анкерное железо 24 см	67
	LR81-403	40'lik Ankraj Demiri 22 cm	40mm Strut Anchor 22 cm	40мм анкерное железо 22 см	67
	LR81-404	40'lik Vidalı Ankraj Demiri	40mm Strut Screwable Anchor	40мм винтовое анкерное железо	67
	LR81-405	Yandan Ankraj Demiri	Anchor from side	Боковое анкерное железо	67
	LR81-406	40'lik Ankraj Demiri 48 cm	40mm anchore 48cm long	Анкер 40 мм, длинный 48 см	67
	LR81-407	40'lik Dekoratif Flaş Ankraji	40mm decorative flange anchor	Декоративный фланцевый анкер 40 мм	68
	LR82-351	M8 x 1000 35'lik Dikme Demiri	M8 x 1000 35mm strut anchore	Анкер для стойки 35 мм M8 x 1000	68
	LR82-352	35'lik Çelik Dübel Takımı	35MM	Комплект стальных дюбелей 35 мм	68
	LR82-601	M6-100 Çelik Dübel (Duvar Dibi)	M6-100 Steel Dowel (Baseboard)	M6-100 стальной дюбель (нижняя часть стены)	68
	LR82-501	M5-100 Alyen Vida	M5-100 Allen Screw	M5-100 винт с шестигранным шлицем	68
	LR82-401	Dikme Dekorlu Bağlantı Demiri	Strut Decorative Steel Connection Bar	Соединительная часть для декорированной опоры	68
	LR83-101	Küpeşte Kapı Menteşesi	Handrail Door Hinge	Дверная петля перилы	68
	LR83-102	Küpeşte Kapı Sürgüsü	Handrail Door Bolt	Дверная задвижка перилы	68
	LR84-101	Epoksi	Epoxy	Эпоксид	69
	LR84-102	Epoksi Tabancası	Epoxy Gun	Эпоксидный пистолет	69
	LR84-103	Selfix Mermer Yapıştırıcısı	Selfix Marble Adhesive	Selfix клей для мрамора	69

















CODE	Ελληνικά	ROMÂNĂ	فارسی	
LR72-502	Καμπυλωτός σωλήνας με κλειδώσεις 50 ρικος	Sistem prindere picior-cot schimbare unghi variabil pentru Ø50	زانوی 50 ملی متر توپی حلقه ای مفصلدار	65 
LR72-503	Ρυθμιζόμενη φλάντζα τοίχου για σωλήνα 50 χιλιοστά	Flansa reglabila mana curenta Ø50 mm - prindere perete	انصال دیواری قابل تنظیم لوله 50 میلی متری	65 
LR72-601	Καμπυλωτός σωλήνας σφαιρικός 60 ρικος	Cot schimbare unghi variabil pentru Ø60	زانوی 60 ملی متر توپی حلقه ای	65 
LR73-301	30 ρικος συνδεδεμένος με κουλούρα 1/8	Cot de 135° pentru Ø30	رابط توپی حلقه ای 30 1/8 ملی متر	65 
LR73-401	40 ρικος συνδεδεμένος με κουλούρα ¼	Cot de 90° pentru Ø40	رابط توپی حلقه ای 40 1/4 ملی متر	65 
LR73-402	40 ρικος συνδεδεμένος με κουλούρα 1/8	Cot de 135° pentru Ø40	رابط توپی حلقه ای 40 1/8 ملی متر	66 
LR73-501	50 ρικος συνδεδεμένος με κουλούρα ¼	Cot de 90° pentru Ø50	رابط توپی حلقه ای 50 1/4 ملی متر	66 
LR73-502	50 ρικος συνδεδεμένος με κουλούρα 1/8	Cot de 135° pentru Ø50	رابط توپی حلقه ای 50 1/8 ملی متر	66 
LR73-601	60 ρικος συνδεδεμένος με κουλούρα ¼	Cot de 90° pentru Ø60	رابط توپی حلقه ای 60 1/4 ملی متر	66 
LR73-602	60 ρικος συνδεδεμένος με κουλούρα 1/8	Cot de 135° pentru Ø60	رابط توپی حلقه ای 60 1/8 ملی متر	66 
LR74-501	50 ρικος με άδαιο ξύλινο βύσμα με κουλούρα 1/8	Cot gol de 135° pentru Ø50	رابط توپی حلقه ای بدون تکیه گاه 50 1/8 ملی متر	66 
LR74-502	50 ρικος με άδαιο ξύλινο βύσμα με κουλούρα ¼	Cot gol de 90° pentru Ø50	رابط حلقه ای بدون تکیه گاه 50 1/4 ملی متر	66 
LR74-503	50 χιλιοστά 1/8 κενό αγκώνα με δακτύλιο	Cot 1/8 - mana curenta Ø50 mm - 135°	زانوی قابل تنظیم 45 درجه برای لوله 50 میلی متری	66 
LR74-504	50 χιλιοστά 1/4 κενό αγκώνα με δακτύλιο	Cot 1/4 - mana curenta Ø50 mm - 90°	زانوی قابل تنظیم 90 درجه برای لوله 50 میلی متری	67 
LR81-301	Σίδερο tot Ανκράζ 30 ρικο.	Element metalic de ancorare Ø30	لنگر فولادی 30 ملی متر	67 
LR81-401	Σίδερο του Ανκράζ 40 ρικα, 14 εκατοστίων	Element metalic de ancorare Ø40 - L=14 cm	لنگر فولادی 40 ملی متر 14 سانتیمتر	67 
LR81-402	Σίδερο του Ανκράζ 40 ρικα, 24 εκατοστίων	Element metalic de ancorare Ø40 - L=24 cm	لنگر فولادی 40 ملی متر 24 سانتیمتر	67 
LR81-403	Σίδερο του Ανκράζ 40 ρικα, 22 εκατοστίων	Element metalic de ancorare Ø40 - L=22 cm	لنگر فولادی 40 ملی متر 22 سانتیمتر	67 
LR81-404	Σίδερο του Ανκράζ 40 ρικα, με βίδα	Element metalic de ancorare filetat Ø40	لنگر فولادی 40 ملی متر پیچدار	67 
LR81-405	Σίδερο του Ανκράζ από τα πλάγια	Element metalic de ancorare laterală	لنگر فولادی نشیمنگاه	67 
LR81-406	Αγκυρα 40 χιλιοστων 48 εκ.	Prezon prindere pardoseala Ø40 mm L=48 cm	(قطعہ جهت نصب لوله 40 میلی متری بلند 48 سانتی متری)	67 
LR81-407	40 χιλιοστων Διακοσμητικη Αγκυρα Φλάντζας	Prezon decorativ prindere pardoseala Ø40 mm L=48 cm	قطعہ جهت نصب لوله 40 میلی متری	68 
LR82-351	M8 x 1 000 Σίδερο Ανέγερσης 35 χιλιοστά	Prezon prindere ardoseala M8 x 1000 mm Ø35 mm	قطعہ نصب 35 میلی متری	68 
LR82-352	35 Χαλύβδινη ούπα	Diblu metalic cu surub L=35 mm	35 میلی متری	68 
LR82-601	M6-100 Χαλύβδινη ούπα (για τη βάση του τοίχου)	Diblu metalic M6 - 100 (pervaz perete)	M6-100 دوپل فولادی (کنار دیوار)	68 
LR82-501	M5- 100 Βίδα από αλγίν	Şurub suport M5 - 100	M5-100 رابط فولادی یا پیچ اتصال	68 
LR82-401	Σίδερο σύνδεσης με ντεκόρ ανύψωσης	Element decorativ metalic cuplare pentru verticală	پیچ اتصال گالوانیزه	68 
LR83-101	Μεντεσές της θύρας της κουπαστής	Balama pentru usi in balustradă	لولای در لبه دار یا زوايه دار	68 
LR83-102	Σύρτης της θύρας της κουπαστής	Zăvor pentru usi in balustradă	کشوی در لبه دار	68 
LR84-101	Eroksi (Εποкси –Εποξια)	Silicon	پيستوله	69 
LR84-102	Πιστολάκι της εποξίας	Pistol pentru silicon	پيستوله و بارنگ پاش	69 
LR84-103	Συγκολλητής μαρμάρων Selfix	Adeziv pentru marmură și granit	چسب سنگ مرمر	69 

	CODE	TÜRKÇE	ENGLISH	Русский	
	LF 311	30 mm Dikdörtgen Ray Profil Flanş	REGULAR FLANGE FOR RECTANGULAR RAIL PROFILE	ФЛАНЕЦ ПРЯМОУГОЛЬНОГО РЕЛЬСОВОГО ПРОФИЛЯ 30 MM	73
	LF 421	Kare Dikme Flanş	REGULAR FLANGE FOR SQUARE POST	ФЛАНЕЦ КВАДРАТНОЙ СТОЙКИ	73
	LF 422	Kare Dikme Flanş Uzun	SQUARE STRUT FLANGE LONG	ФЛАНЕЦ КВАДРАТНОЙ СТОЙКИ ДЛИННЫЙ	73
	LF 521	Dikdörtgen Dikme Flanş	FLANGE FOR RECTANGULAR POST	ФЛАНЕЦ ПРЯМОУГОЛЬНОЙ СТОЙКИ	73
	LF 522	Dikdörtgen Dikme Flanş Uzun	RECTANGLE STRUT FLANGE LONG	ФЛАНЕЦ ПРЯМОУГОЛЬНОЙ СТОЙКИ ДЛИННЫЙ	73
	LF 611	60x25 mm Dikdörtgen Kúpeşte Flanş	FLANGE FOR 60x25 MM RECTANGULAR HANDRAIL	ФЛАНЕЦ ПРЯМОУГОЛЬНОГО ПОРУЧНЯ 60 x 25 MM	73
	LF 611A	60x25 mm Dikdörtgen Kúpeşte Flanş	60x25 MM RECTANGLE BALUSTRADE FLANGE	ПРЯМОУГОЛЬНЫЙ ФЛАНЕЦ ДЛЯ ПОРУЧНЯ 60 x 25 MM	73
	LF 751	75x75 mm Kare Baba Flanş	FLANGE FOR 75x75 SQUARE COLUMN	КВАДРАТНЫЙ ФЛАНЕЦ ДЛЯ КОЛОННЫЙ 75 x 75 MM	73
	LF 801	80x30 mm Dikdörtgen Kúpeşte Duvar Flanş	WALL FLANGE FOR 80x30 MM RECTANGULAR HANDRAIL	НАСТЕННЫЙ ФЛАНЕЦ ПРЯМОУГОЛЬНОГО ПОРУЧНЯ 80 x 30 MM	74
	LF 801A	80x30 mm Dikdörtgen Kúpeşte Duvar Flanş	80x30 MM RECTANGLE BALUSTRADE WALL FLANGE	НАСТЕННЫЙ ФЛАНЕЦ ПРЯМОУГОЛЬНОГО ПОРУЧНЯ 80 x 30 MM	74
	LM 102A	Duvar Kúpestesini L Mafsali	RAIL WALL L JOINT	L-ОБРАЗНЫЙ ШАРНИР ДЛЯ НАСТЕННОГО ПОРУЧНЯ	74
	LM 411B	4020 Seri Dikdörtgen Kúpeşte Mafsali	RECTANGULAR POST JOINT	ПРЯМОУГОЛЬНЫЙ ШАРНИР ДЛЯ ПОРУЧНЯ СЕРИИ 4020	74
	LM 417	4020 Seri Dikdörtgen Kúpeşte Mafsali	4020 SERIE BRACKET FOR RECTANGULAR HANDRAIL	ПРЯМОУГОЛЬНЫЙ ШАРНИР ДЛЯ ПОРУЧНЯ СЕРИИ 4020	74
	LM 417A	4020 Seri Dikdörtgen Köşe Kúpeşte Mafsali	RECTANGULAR CORNER POST JOINT	ПРЯМОУГОЛЬНЫЙ УГЛОВОЙ ШАРНИР ДЛЯ ПОРУЧНЯ СЕРИИ 4020	74
	LM 417B	4020 Seri Dikdörtgen Köşe Kúpeşte Mafsali	4020 SERIE CORNER BRACKET FOR RECTANGULAR HANDRAIL	ПРЯМОУГОЛЬНЫЙ УГЛОВОЙ ШАРНИР ДЛЯ ПОРУЧНЯ СЕРИИ 4020	74
	LM 418	4020 Seri Dikdörtgen Köşe Kúpeşte Mafsali 80x30	4020 SERIE CORNER BRACKET FOR RECTANGULAR HANDRAIL	УГЛОВОЙ ШАРНИР ДЛЯ ПРЯМОУГОЛЬНОГО ПОРУЧНЯ СЕРИИ 4020	74
	LM 419	4020 Seri Dikdörtgen Köşe Kúpeşte Mafsali 60x25	4020 SERIE CORNER BRACKET FOR RECTANGULAR HANDRAIL	УГЛОВОЙ ШАРНИР ДЛЯ ПРЯМОУГОЛЬНОГО ПОРУЧНЯ СЕРИИ 4020	75
	LM 421	Kare Dikme Üstten Mafsali	REGULAR BRACKET FOR 40 MM SQUARE POST	ШАРНИР ДЛЯ КВАДРАТНОЙ СТОЙКИ С КРЕПЛЕНИЕМ СВЕРХУ	75
	LM 421B	Kare Dikme Dikdörtgen Kúpeşte Mafsali	SQUARE CORNER POST JOINT	ШАРНИР ДЛЯ ПРЯМОУГОЛЬНОГО ПОРУЧНЯ, КВАДРАТНОЙ СТОЙКИ	75
	LM 422A	Dikdörtgen Kúpeşte Mafsali	RECTANGULAR L JOINT	ПРЯМОУГОЛЬНЫЙ ПОРУЧЕНЬ	75
	LM 425	Kare Dikme Sabit Mafsali	STABLE BRACKET FOR 40MM SQUARE POST	СТАЦИОНАРНЫЙ ШАРНИР ДЛЯ ПРЯМОУГОЛЬНОЙ СТОЙКИ	75
	LM 425A	Kare Dikme Üstten Mafsali	SQUARE POST JOINT FROM TOP	ШАРНИР ДЛЯ КВАДРАТНОЙ СТОЙКИ С КРЕПЛЕНИЕМ СВЕРХУ	75
	LM 426	Kare Dikme Köşe Mafsali	CORNER BRACKET FOR 40MM SQUARE POST	КВАДРАТНЫЙ УГЛОВОЙ ШАРНИР ДЛЯ СТОЙКИ	75
	LM 427	Kare Dikme Dikdörtgen Kúpeşte Mafsali	40 MM SQUARE BRACKET FOR RECTANGULAR HANDRAIL	ШАРНИР ДЛЯ ПРЯМОУГОЛЬНОГО ПОРУЧНЯ, КВАДРАТНОЙ СТОЙКИ	75
	LM 427A	Kare Dikme Dikdörtgen Kúpeşte Köşe Mafsali	40 MM SQUARE CORNER BRACKET FOR RECTANGULAR HANDRAIL	УГЛОВОЙ ШАРНИР ДЛЯ ПРЯМОУГОЛЬНОГО ПОРУЧНЯ, КВАДРАТНАЯ СТОЙКА	76
	LM 427B	Kare Dikme Dikdörtgen Kúpeşte Köşe Mafsali	SQUARE POST REGTANGULAR RAIL JOINT	УГЛОВОЙ ШАРНИР ДЛЯ ПРЯМОУГОЛЬНОГО ПОРУЧНЯ, КВАДРАТНАЯ СТОЙКА	76
	LM 427E	Ekonomik Dikdörtgen Kúpeşte Mafsali	ECONOMIC RECTANGULAR JOINT	ЭКОНОМИЧНЫЙ ПРЯМОУГОЛЬНЫЙ ПОРУЧЕНЬ	76
	LM 428	Kare Dikme Dikdörtgen Kúpeşte Köşe Mafsali 80x30	40 MM SQUARE CORNER BRACKET FOR RECTANGULAR HANDRAIL	УГЛОВОЙ ШАРНИР ДЛЯ ПРЯМОУГОЛЬНОГО ПОРУЧНЯ, КВАДРАТНАЯ СТОЙКА	76
	LM 429	Kare Dikme Dikdörtgen Kúpeşte Köşe Mafsali 60x25	SQUARE POST REGTANGULAR RAIL CORNER JOINT	УГЛОВОЙ ШАРНИР ДЛЯ ПРЯМОУГОЛЬНОГО ПОРУЧНЯ, КВАДРАТНАЯ СТОЙКА	76
	LM 521	Dikdörtgen Dikme Üstten Mafsali	RECTANGLE POST JOINT FROM TOP	ШАРНИР ДЛЯ ПРЯМОУГОЛЬНОЙ СТОЙКИ С КРЕПЛЕНИЕМ СВЕРХУ	76
	LM 521B	Dikdörtgen Dikme Dikdörtgen Kúpeşte Mafsali	RECTANGULAR POST REGTANGLE RAIL JOINT	ШАРНИР ДЛЯ ПРЯМОУГОЛЬНОГО ПОРУЧНЯ, ПРЯМОУГОЛЬНАЯ СТОЙКА	76
	LM 525	Dikdörtgen Dikme Sabit Mafsali	STABLE BRACKET FOR RECTANGULAR POST	СТАЦИОНАРНЫЙ ШАРНИР ДЛЯ ПРЯМОУГОЛЬНОЙ СТОЙКИ	76

CODE	Ελληνικά	ROMÂNĂ	فارسی	
LF 311	ΟΡΘΟΓΩΝΙΑ ΦΛΑΝΤΖΑ ΠΡΟΦΙΛ ΣΙΔΗΡΟΔΡΟΜΟΥ 30 ΧΙΛΙΟΣΤΑ	Flansa regulara pentru profil dreptunghiular de 30 mm cu sine	اتصال دسته برای پروفیل چهارگوش 30*25	73
LF 421	ΤΕΤΡΑΓΩΝΗ ΦΛΑΝΤΖΑ ΚΑΘΕΤΗ	Flansa pentru montura patrata	روکش کوناه پایه چهارگوش 40	73
LF 422	ΤΕΤΡΑΓΩΝΗ ΦΛΑΝΤΖΑ ΚΑΘΕΤΗ ΜΑΚΡΙΑ	Flansa patrata #40 mm	روکش بلند پایه پروفیل چهارگوش شماره دار 40	73
LF 521	ΟΡΘΟΓΩΝΙΑ ΦΛΑΝΤΖΑ ΚΑΘΕΤΗ	Flansa pentru montura dreptunghiulara	روکش پایه چهارگوش شماره دار 50*25	73
LF 522	ΟΡΘΟΓΩΝΙΑ ΦΛΑΝΤΖΑ ΚΑΘΕΤΗ ΜΑΚΡΙΑ	Flansa dreptunghiulara #50x25 mm	روکش بلند پایه پروفیل چهارگوش شماره دار 30*20	73
LF 611	ΟΡΘΟΓΩΝΙΑ ΦΛΑΝΤΖΑ ΚΟΥΠΑΣΤΗ 60 Χ 25 ΧΙΛΙΟΣΤΑ	Flansa cu balustrada dreptunghiulara de 60x25 mm	روکش پایه چهارگوش 60*25	73
LF 611A	ΟΡΘΟΓΩΝΙΑ ΦΛΑΝΤΖΑ ΚΟΥΠΑΣΤΗ 60 Χ 25 ΧΙΛΙΟΣΤΑ	Flansa dreptunghiulara pentru balustrada #60x25 mm	روکش پایه چهارگوش 60*25	73
LF 751	ΤΕΤΡΑΓΩΝΗ ΦΛΑΝΤΖΑ ΓΙΑ ΣΤΗΛΗ 75 Χ 75 ΧΙΛΙΟΣΤΑ	Flansa pentru coloana dreapta de 75x75	روکش پایه چهارگوش 75	73
LF 801	ΟΡΘΟΓΩΝΙΑ ΦΛΑΝΤΖΑ ΚΟΥΠΑΣΤΗ ΓΙΑ ΤΟΙΧΟ 80 Χ 30 ΧΙΛΙΟΣΤΑ	Flansa pentru perete cu balustrada dreptunghiulara de 80x30 mm	اتصال دیواری چهارگوش 80*30	74
LF 801A	ΟΡΘΟΓΩΝΙΑ ΦΛΑΝΤΖΑ ΚΟΥΠΑΣΤΗ ΓΙΑ ΤΟΙΧΟ 80 Χ 30 ΧΙΛΙΟΣΤΑ	Flansa dreptunghiulara pt. perete - balustrada #80x30 mm	اتصال دیواری چهارگوش 80*30	74
LM 102A	ΑΡΘΡΩΤΟ L ΚΟΥΠΑΣΤΗ ΤΟΙΧΟΥ	Conector "L" pentru perete	اتصال دیواری دسته	74
LM 411B	ΟΡΘΟΓΩΝΙΟ ΑΡΘΡΩΤΟ ΚΟΥΠΑΣΤΗ ΣΕΙΡΑΣ 4020	Imbinare rectangulara	اتصال پایه و دسته چهارگوش	74
LM 417	ΟΡΘΟΓΩΝΙΟ ΑΡΘΡΩΤΟ ΚΟΥΠΑΣΤΗ ΣΕΙΡΑΣ 4020	Articulatie Dreptunghiulara Seria 4020	(اتصال پایه و دسته چهارگوش) سری 4020	74
LM 417A	ΟΡΘΟΓΩΝΙΟ ΑΡΘΡΩΤΟ ΓΩΝΙΑΚΗΣ ΚΟΥΠΑΣΤΗΣ ΣΕΙΡΑΣ 4020	Imbinare rectangulara la 90°	اتصال زاویه پایه و دسته چهارگوش	74
LM 417B	ΟΡΘΟΓΩΝΙΟ ΑΡΘΡΩΤΟ ΓΩΝΙΑΚΗΣ ΚΟΥΠΑΣΤΗΣ ΣΕΙΡΑΣ 4020	Imbinare rectangulara la 90°	اتصال زاویه پایه و دسته چهارگوش	74
LM 418	ΟΡΘΟΓΩΝΙΟ ΑΡΘΡΩΤΟ ΓΩΝΙΑΚΗΣ ΚΟΥΠΑΣΤΗΣ ΣΕΙΡΑΣ 4020	Articulatie Dreptunghiulara Colt Seria 4020	اتصال زاویه چهارگوش سری 4020	74
LM 419	ΟΡΘΟΓΩΝΙΟ ΑΡΘΡΩΤΟ ΓΩΝΙΑΚΗΣ ΚΟΥΠΑΣΤΗΣ ΣΕΙΡΑΣ 4020	Imbinare rectangulara la 90°	اتصال زاویه چهارگوش	75
LM 421	ΤΕΤΡΑΓΩΝΟ ΑΛΑΖΟΝΙΚΟ ΑΡΘΡΩΤΟ ΑΠΟ ΠΛΑΝΟ	Articulatie cu montura patrata	اتصال لوله 50 و 60 و پروفیل چهارگوش 40	75
LM 421B	ΤΕΤΡΑΓΩΝΟ ΑΛΑΖΟΝΙΚΟ ΟΡΘΟΓΩΝΙΟ ΑΡΘΡΩΤΟ ΚΟΥΠΑΣΤΗ	Square corner post joint	اتصال زاویه پایه و دسته چهارگوش	75
LM 422A	ΟΡΘΟΓΩΝΙΑ ΚΟΥΠΑΣΤΗ	Imbinare rectangulara pentru perete	اتصال پروفیل چهارگوش	75
LM 425	ΣΤΑΘΕΡΟ ΑΡΘΡΩΤΟ ΤΕΤΡΑΓΩΝΟΥ ΑΛΑΖΟΝΙΚΟΥ	Articulatie fixa cu montura patrata	اتصال لوله 50 و پروفیل چهارگوش 40 میلی متری	75
LM 425A	ΕΠΑΝΩ ΑΡΘΡΩΤΟ ΤΕΤΡΑΓΩΝΟΥ ΑΛΑΖΟΝΙΚΟΥ	Sistem prindere mana curenta Ø50	اتصال لوله 50 و 60 و پروفیل چهارگوش	75
LM 426	ΓΩΝΙΑΚΟ ΑΡΘΡΩΤΟ ΤΕΤΡΑΓΩΝΟΥ ΑΛΑΖΟΝΙΚΟΥ	Articulatie colt cu montura patrata	زاویه اتصال لوله 50 و پروفیل چهارگوش 40 میلی متری	75
LM 427	ΟΡΘΟΓΩΝΙΟ ΓΩΝΙΑΚΟ ΑΡΘΡΩΤΟ ΚΟΥΠΑΣΤΗ ΤΕΤΡΑΓΩΝΟΥ ΑΛΑΖΟΝΙΚΟΥ	Articulatie dreptunghiulara cu montura patrata	اتصال پروفیل چهارگوش 40 میلی متری	75
LM 427A	ΟΡΘΟΓΩΝΙΟ ΓΩΝΙΑΚΟ ΑΡΘΡΩΤΟ ΚΟΥΠΑΣΤΗ ΤΕΤΡΑΓΩΝΟΥ ΑΛΑΖΟΝΙΚΟΥ	Articulatie dreptunghiulara de colt cu montura patrata	اتصال زاویه پروفیل چهارگوش 40 میلی متری	76
LM 427B	ΟΡΘΟΓΩΝΙΟ ΓΩΝΙΑΚΟ ΑΡΘΡΩΤΟ ΚΟΥΠΑΣΤΗ ΤΕΤΡΑΓΩΝΟΥ ΑΛΑΖΟΝΙΚΟΥ	Imbinare rectangulara pentru perete	اتصال زاویه پایه و دسته چهارگوش	76
LM 427E	ΟΙΚΟΝΟΜΙΚΗ ΤΕΤΡΑΓΩΝΗ ΚΟΥΠΑΣΤΗ	Imbinare economica rectangulara	اتصال پروفیل چهارگوش	76
LM 428	ΟΡΘΟΓΩΝΙΟ ΓΩΝΙΑΚΟ ΑΡΘΡΩΤΟ ΚΟΥΠΑΣΤΗ ΤΕΤΡΑΓΩΝΟΥ ΑΛΑΖΟΝΙΚΟΥ	Articulatie dreptunghiulara de colt cu montura patrata	زاویه اتصال 40 میلی متری و پروفیل 80*30	76
LM 429	ΟΡΘΟΓΩΝΙΟ ΓΩΝΙΑΚΟ ΑΡΘΡΩΤΟ ΚΟΥΠΑΣΤΗ ΤΕΤΡΑΓΩΝΟΥ ΑΛΑΖΟΝΙΚΟΥ	Imbinare rectangulara pentru perete	اتصال پروفیل 40 میلی متری و پروفیل 60*25	76
LM 521	ΕΠΑΝΩ ΑΡΘΡΩΤΟ ΟΡΘΟΓΩΝΙΟΥ ΑΛΑΖΟΝΙΚΟΥ	Rectangle post joint from top	اتصال لوله 50 و 60 و پروفیل چهارگوش	76
LM 521B	ΟΡΘΟΓΩΝΙΟ ΓΩΝΙΑΚΟ ΑΡΘΡΩΤΟ ΚΟΥΠΑΣΤΗ ΟΡΘΟΓΩΝΙΟΥ ΑΛΑΖΟΝΙΚΟΥ	Rectangle post joint from top	اتصال پایه و دسته پروفیل چهارگوش	76
LM 525	ΣΤΑΘΕΡΟ ΑΡΘΡΩΤΟ ΟΡΘΟΓΩΝΙΟΥ ΑΛΑΖΟΝΙΚΟΥ	Articulatie fixa cu montura patrata	اتصال لوله 50 و پایه چهارگوش	76

	CODE	TÜRKÇE	ENGLISH	Русский	
	LM 527	Dikdörtgen Dikme Dikdörtgen Küpeşte Mafsaltz	RECTANGULAR HANDRAIL BRACKET FOR RECTANGULAR POST	ШАРНИР ДЛЯ ПРЯМОУГОЛЬНОГО ПОРУЧНЯ, ПРЯМОУГОЛЬНАЯ СТОЙКА	77
	LB 141	Kare profil Bileziği 14 x 14	RING FOR 14x14 SQUARE PROFILE	14 x 14 МУФТА КВАДРАТНОГО ПРОФИЛЯ	77
	LB 311	30 mm Dikdörtgen Ray Profil Bileziği 30 x 25	RING FOR 30 MM RECTANGULAR RAIL PROFILE	30 ММ МУФТА ПРЯМОУГОЛЬНОГО РЕЛЬСОВОГО ПРОФИЛЯ	77
	LB 611	Dikdörtgen Küpeşte Bileziği 60 x 25	RING FOR 60x25 MM RECTANGULAR HANDRAIL	60 x 25 ММ МУФТА ПРЯМОУГОЛЬНОГО ПОРУЧНЯ	77
	LB 801	Dikdörtgen Küpeşte Bileziği 80 x 30	RING FOR 80x30 MM RECTANGULAR HANDRAIL	80 x 30 ММ МУФТА ПРЯМОУГОЛЬНОГО ПОРУЧНЯ	77
	LT 141	Kare Profil Tapası 14 x 14	CAP FOR 14x14 SQUARE PROFILE	14 x 14 ЗАГЛУШКА КВАДРАТНОГО ПРОФИЛЯ	77
	LT 311	30 mm Dikdörtgen Ray Profil Tapası	CAP FOR 30 MM RECTANGULAR RAIL PROFILE	30 ММ ЗАГЛУШКА ПРЯМОУГОЛЬНОГО РЕЛЬСОВОГО ПРОФИЛЯ	77
	LT 421	Kare Dikme Tapası	CAP FOR 40MM SQUARE POST	КВАДРАТНАЯ ЗАГЛУШКА ДЛЯ СТОЙКИ	77
	LT 611	Dikdörtgen Küpeşte Tapası 60 x 25	CAP FOR 60x25 RECTANGULAR HANDRAIL PROFILE	60 x 25 ПРЯМОУГОЛЬНАЯ ЗАГЛУШКА ДЛЯ ПОРУЧНЯ	78
	LT 751	Kare Baba Tapası 75 x 75	CAP FOR 75x75 SQUARE COLUMN	75 x 75 СФЕРИЧЕСКАЯ ЗАГЛУШКА ДЛЯ КОЛОННЫ	78
	LT 801	Dikdörtgen Küpeşte Tapası 80 x 30	CAP FOR 80x30 MM RECTANGULAR HANDRAIL	80 x 30 ММ ПРЯМОУГОЛЬНАЯ ЗАГЛУШКА ДЛЯ ПОРУЧНЯ	78
	LT 306	18-306-00 Profil Yan Tapası	18-306-00 PROFILE SIDE CAP	18-306-00 БОКОВАЯ ЗАГЛУШКА ПРОФИЛЬНАЯ	78
	LC 521	Dikdörtgen Dikme Cam Tutucu	GLASS HOLDER FOR RECTANGULAR POST	СТЕКЛЯНЫЙ ШТАПИК ДЛЯ ПРЯМОУГОЛЬНОЙ СТОЙКИ	78
	LC 421	Kare Dikmeye Göre Cam Tutucu	REGULAR GLASS HOLDER FOR 40 MM SQUARE POST	СТЕКЛО ДЕРЖАТЕЛЬ ДЛЯ КВАДРАТНОЙ СТОЙКИ	78
	LY 103	Kare Çapraz Motif Göbeği 12 x 12	12x12 MM PROFILE DIAGONAL CENTER HOLDER	12 x 12 ММ ПЕРЕХОДНИК КВАДРАТНЫЙ С ДИАГОНАЛЬНЫМ МОТИВОМ	78
	LY 311	30 mm Dikdörtgen Ray Profil Bağlantı Adaptörü (Sağ)	ADAPTOR FOR 30 MM RECTANGULAR RAIL PROFILE	30 ММ СОЕДИНИТЕЛЬНЫЙ АДАПТЕР ПРЯМОУГОЛЬНОГО РЕЛЬСОВОГО ПРОФИЛЯ (ПРАВЫЙ)	78
	LY 311A	30 mm Dikdörtgen Ray Profil Bağlantı Adaptörü (Sol)	30x25 30 MM RECTANGLE RAIL PROFILE JOINT ELEMENT (LEFT)	30 ММ СОЕДИНИТЕЛЬНЫЙ АДАПТЕР ПРЯМОУГОЛЬНОГО РЕЛЬСОВОГО ПРОФИЛЯ (ПРАВЫЙ)	79
	LY 402A	40 mm Dikme Kare Adaptörü Boruya Göre	SQUARE ADAPTER FOR ROUND PART OF	40 ММ СОЕДИНИТЕЛЬНЫЙ АДАПТЕР ДЛЯ СТОЙКИ В СООТВЕТСТВИИ С ТРУБОЙ	79
	LY 428	Kare Dikme Yan Bağlantı Pabucu	SIDE INSTALLATION BRACKET FOR SQUARE POST	СТЯЖКА ДЛЯ КВАДРАТНОЙ СТОЙКИ	79
	LY 428A	Kare Dikme Yan Bağlantı Pabucu (Uzun)	40 SIDE INSTALLATION BRACKET FOR SQUARE POST (LONG)	Стяжка для квадратной стойки длины	79
	LY 521	Dikdörtgen Dikme Yan Bağlantı Pabucu	50 x 25 SIDE INSTALLATION BRACKET FOR RECTANGULAR POST	БОКОВОЕ КРЕПЛЕНИЕ ДЛЯ ПРЯМОУГОЛЬНОЙ СТОЙКИ	79
	LY 521A	Dikdörtgen Dikme Yan Bağlantı Pabucu (Uzun)	50 x 25 SIDE INSTALLATION BRACKET FOR RECTANGLE POST (LONG)	БОКОВОЕ КРЕПЛЕНИЕ ДЛЯ ПРЯМОУГОЛЬНОЙ СТОЙКИ (ДЛИННОЕ)	79
	LY 611	Dikdörtgen Küpeşte Bağlantı Adaptörü 60 x 25	WALL ADAPTER FOR 60x25 RECTANGULAR HANDRAIL	60 x 25 СОЕДИНИТЕЛЬНЫЙ АДАПТЕР ПРЯМОУГОЛЬНОГО ПОРУЧНЯ	79
	LS 141	Kare 90° Dönüş 14 X 14	90° ELBOW FOR 14x14 MM	14 x 14 КВАДРАТНЫЙ УГЛОВОЙ АДАПТЕР 90°	79
	LS 142	Kare 45° Dönüş 14 X 14	45° ELBOW FOR 14x14 MM	14 x 14 КВАДРАТНЫЙ УГЛОВОЙ АДАПТЕР 45°	80
	LS 142A	Kare 30° Dönüş 14 X 14	30° ELBOW FOR 14x14 MM	14 x 14 КВАДРАТНЫЙ УГЛОВОЙ АДАПТЕР 30°	80
	LS 143	Kare Dönüş Küresi 0 - 90° 14 x 14	ADJUSTABLE ELBOW FOR 14x14 MM	14 x 14 УГЛОВОЙ РЕГУЛИРУЕМЫЙ (СФЕРИЧЕСКИЙ) АДАПТЕР 0 - 90°	80
	LS 311	Dikdörtgen 90° Dönüş 30 x 25	30x25 RECTANGLE 90° BEND	30 x 25 ПРЯМОУГОЛЬНЫЙ УГЛОВОЙ АДАПТЕР 90°	80
	LS 314	Dikdörtgen Dönüş Küresi 30 x 25	30x25 RECTANGLE 90° CORNER JOINT	30 x 25 ПРЯМОУГОЛЬНОЕ УГЛОВОЙ РЕГУЛИРУЕМОЕ КРЕПЛЕНИЕ	80
	LS 506	Cam Kanallı Ayarlanabilir Dizek 0 - 90°	0 - 90° ADJUSTABLE ELBOW	РЕГУЛИРУЕМОЕ КОЛЕНО С КАНАЛОМ ДЛЯ СТЕКЛА 0 - 90°	80

CODE	Ελληνικά	ROMÂNĂ	فارسی	
LM 527	ΟΡΘΟΓΩΝΙΟ ΓΩΝΙΑΚΟ ΑΡΘΡΩΤΟ ΚΟΥΠΙΑΣΤΗ ΟΡΘΟΓΩΝΙΟΥ ΑΛΑΖΟΝΙΚΟΥ	Articulație dreptunghiulară cu montura dreptunghiulară	انصال پایه و دسته چهارگوش	77
LB 141	14 X 14 ΔΑΚΤΥΛΙΟΣ ΤΕΤΡΑΓΩΝΟΥ ΠΡΟΦΙΛ	Bratara pentru profil patrat 14x14	حلقه 14*14 مربع شکل	77
LB 311	ΔΑΚΤΥΛΙΟΣ ΟΡΘΟΓΩΝΙΟΥ ΠΡΟΦΙΛ ΣΙΔΗΡΟΔΡΟΜΟΥ 30 ΧΙΛΙΟΣΤΩΝ	Bratara pentru profil dreptunghiular cu role 30 mm	حلقه برای پروفیل 30 میلی متری چهارگوش	77
LB 611	60 X 25 ΧΙΛΙΟΣΤΑ ΟΡΘΟΓΩΝΙΟΣ ΔΑΚΤΥΛΙΟΣ ΚΟΥΠΙΑΣΤΗ	Bratara dreptunghiulară cu balustrada 60x25 mm	حلقه برای پروفیل 60*25 میلی متری	77
LB 801	80 X 30 ΧΙΛΙΟΣΤΑ ΟΡΘΟΓΩΝΙΟΣ ΔΑΚΤΥΛΙΟΣ ΚΟΥΠΙΑΣΤΗ	Bratara dreptunghiulară cu balustrada 80x30 mm	حلقه برای پروفیل 80*30 میلی متری	77
LT 141	14 X 14 ΒΥΣΜΑ ΤΕΤΡΑΓΩΝΟΥ ΠΡΟΦΙΛ	Dop cu profil patrat 14X14	درپوش پروفیل 14*14 میلی متری	77
LT 311	30 ΧΙΛΙΟΣΤΑ ΒΥΣΜΑ ΟΡΘΟΓΩΝΙΟΥ ΠΡΟΦΙΛ ΣΙΔΗΡΟΔΡΟΜΟΥ	Dop cu profil dreptunghiular cu role 30 mm	درپوش زاویه برای پروفیل 30 میلی متری	77
LT 421	ΒΥΣΜΑ ΤΕΤΡΑΓΩΝΟΥ ΑΛΑΖΟΝΙΚΟΥ	Dop cu montura patrata	درپوش پروفیل 40 میلی متری چهارگوش	77
LT 611	60 X 25 ΒΥΣΜΑ ΟΡΘΟΓΩΝΙΑΣ ΚΟΥΠΙΑΣΤΗΣ	Dop cu balustrada dreptunghiulară 60X25	درپوش برای پروفیل 60*25	78
LT 751	75 X 75 ΒΥΣΜΑ ΤΕΤΡΑΓΩΝΗΣ ΣΤΗΛΗΣ	Dop pentru columna de 75x75	دسته برای پایه 75*75	78
LT 801	80 X 30 ΧΙΛΙΟΣΤΑ ΒΥΣΜΑ ΟΡΘΟΓΩΝΙΑΣ ΚΟΥΠΙΑΣΤΗΣ	Dop dreptunghiular cu balustrada de 80x30 mm	درپوش پروفیل 80*30	78
LT 306	ΠΡΟΦΙΛ ΠΛΕΥΡΙΚΗ ΒΑΣΗ 18-306-00	DOP CAPAT PROFIL 18-306-00	درپوش پروفیل بغل 18-306-00	78
LC 521	ΒΑΣΗ ΤΖΑΜΙΟΥ ΓΙΑ ΟΡΘΟΓΩΝΙΑ ΚΟΛΩΝΑ	GLASS HOLDER FOR RECTANGULAR POST	نگهدارنده شیشه	78
LC 421	ΛΑΒΗ ΓΥΑΛΙΟΥ ΤΕΤΡΑΓΩΝΟΥ ΑΛΑΖΟΝΙΚΟΥ	Suport geam pentru montura patrata	نگهدارنده شیشه برای پروفیل 40 میلی متری	78
LY 103	ΚΕΝΤΡΟ ΤΕΤΡΑΓΩΝΟΥ ΣΤΑΥΡΟΤΟΥ ΜΟΤΙΒΟΥ 12 X 12	Suport central cu profil diagonal 12x12 mm	قطعه وسط نرده	78
LY 311	ΠΡΟΣΑΡΜΟΓΕΑΣ ΣΥΝΔΕΣΗΣ ΟΡΘΟΓΩΝΙΟΥ ΣΙΔΗΡΟΔΡΟΜΙΚΟΥ ΠΡΟΦΙΛ 30 ΧΙΛΙΟΣΤΩΝ (ΔΕΞΙ)	Adaptor pentru profil dreptunghiular cu role 30 mm (dreapta)	انصال پروفیل 30 میلی متری چهارگوش	78
LY 311A	ΠΡΟΣΑΡΜΟΓΕΑΣ ΣΥΝΔΕΣΗΣ ΟΡΘΟΓΩΝΙΟΥ ΣΙΔΗΡΟΔΡΟΜΙΚΟΥ ΠΡΟΦΙΛ 30 ΧΙΛΙΟΣΤΩΝ (ΑΡΙΣΤΕΡΟ)	Element 30 mm de legatura pentru mana curenta rectangulara 30x25 (stanga)	انصال پروفیل 30 میلی متری چهارگوش	79
LY 402A	ΠΡΟΣΑΡΜΟΓΕΑΣ ΤΕΤΡΑΓΩΝΟΥ ΑΛΑΖΟΝΙΚΟΥ ΑΝΑΛΟΓΑ ΜΕ ΤΟΝ ΣΩΛΗΝΑ 40 ΧΙΛΙΟΣΤΩΝ	Adaptor cu montura pentru teava de 40 mm	انصال پروفیل چهارگوش و پروفیل لوله	79
LY 428	ΤΕΡΜΑΤΙΚΟ ΣΥΝΔΕΣΗΣ ΠΛΑΙΣΙΟΥ ΤΕΤΡΑΓΩΝΟΥ ΑΛΑΖΟΝΙΚΟΥ (ΜΑΚΡΗ)	Brat conectare laterala cu montura patrata	قطعه انصال دیواری برای پروفیل چهارگوش	79
LY 428A	ΤΕΡΜΑΤΙΚΟ ΣΥΝΔΕΣΗΣ ΠΛΑΙΣΙΟΥ ΤΕΤΡΑΓΩΝΟΥ ΑΛΑΖΟΝΙΚΟΥ (ΜΑΚΡΗ)	Prindere laterala pentru mana curenta rectangulara 40 x 40	قطعه انصال دیواری بلند برای پروفیل چهارگوش 40	79
LY 521	ΤΕΡΜΑΤΙΚΟ ΣΥΝΔΕΣΗΣ ΠΛΑΙΣΙΟΥ ΟΡΘΟΓΩΝΙΟΥ ΑΛΑΖΟΝΙΚΟΥ	Brat conectare laterala cu montura dreptunghiulara 50X25	قطعه انصال دیواری برای پروفیل چهارگوش 50*25	79
LY 521A	ΤΕΡΜΑΤΙΚΟ ΣΥΝΔΕΣΗΣ ΠΛΑΙΣΙΟΥ ΟΡΘΟΓΩΝΙΟΥ ΑΛΑΖΟΝΙΚΟΥ (ΜΑΚΡΗ)	Prindere laterala pentru mana curenta rectangulara 50 x 25	قطعه انصال دیواری بلند برای پروفیل چهارگوش 50*25	79
LY 611	ΠΡΟΣΑΡΜΟΓΕΑΣ ΣΥΝΔΕΣΗΣ ΟΡΘΟΓΩΝΙΑΣ ΚΟΥΠΙΑΣΤΗΣ 60 X 25	Adaptor cu montura dreptunghiulara (lung) 60X25	قطعه انصال دیواری برای پروفیل چهارگوش 60*25	79
LS 141	14 X 14 ΤΕΤΡΑΓΩΝΟΣ ΑΓΚΩΝΑΣ 90°	Cot patrat 90° pentru 14x14 mm	زانوی 90 درجه برای پروفیل 14*14	79
LS 142	14 X 14 ΤΕΤΡΑΓΩΝΟΣ ΑΓΚΩΝΑΣ 45°	Cot patrat 45° pentru 14x14 mm	زانوی 45 درجه برای پروفیل 14*14	80
LS 142A	14 X 14 ΤΕΤΡΑΓΩΝΟΣ ΑΓΚΩΝΑΣ 30°	Cot patrat 30° pentru 14x14 mm	زانوی 30 درجه برای پروفیل 14*14	80
LS 143	14 X 14 ΣΦΑΙΡΑ ΑΓΚΩΝΑΣ 0 - 90°	Cot sferic ajustabil 0 - 90° pentru 14x14 mm	زانوی قابل تنظیم برای پروفیل 14*14	80
LS 311	30 X 25 ΟΡΘΟΓΩΝΙΟΣ ΑΓΚΩΝΑΣ 90°	Conector pentru rectangulara 30 x 25	زاویه خم 90 درجه برای پروفیل 30*25	80
LS 314	30 X 25 ΣΦΑΙΡΑ ΟΡΘΟΓΩΝΙΟΥ ΑΓΚΩΝΑΣ	Coltar 90° pentru rectangulara 30 x 25	زاویه خم 90 درجه برای پروفیل 30*25	80
LS 506	ΡΥΘΜΙΖΟΜΕΝΟΣ ΑΓΚΩΝΑΣ ΜΕ ΓΥΑΛΙΝΟ ΚΑΝΑΛΙ 0 - 90°	Imbinare unghi variabil 0 - 90°	زانوی قابل تنظیم 0-90 درجه	80









	CODE	TÜRKÇE	ENGLISH	Русский	
	LS 611B	90° Köşe Birleşim Sacı 60x25	60X25 90° CORNER JOINT PLATE	90° УГЛОВАЯ СОЕДИНИТЕЛЬНАЯ ПЛАСТИНА	80
	LS 612B	45° Köşe Birleşim Sacı	60X25 45° CORNER JOINT PLATE	45° УГЛОВАЯ СОЕДИНИТЕЛЬНАЯ ПЛАСТИНА	80
	LS 614	Dikdörtgen Küpeşte Ayarlı Dönüş Küresi 0 - 90° 60 x 25	60x25 MM REGTANGLE RAIL ADJUSTABLE CORNER 0 - 90°	60 x 25 MM УГЛОВОЙ РЕГУЛИРУЕМЫЙ АДАПТЕР 0 - 90° ДЛЯ ПРЯМОУГОЛЬНОГО ПОРУЧНЯ	81
	LS 614A	Dikdörtgen Küpeşte Ayarlı Dönüş Küresi 0 - 45° 60 x 25	60x25 MM REGTANGLE RAIL ADJUSTABLE CORNER 0 - 45°	60 x 25 MM УГЛОВОЙ РЕГУЛИРУЕМЫЙ АДАПТЕР 0 - 45° ДЛЯ ПРЯМОУГОЛЬНОГО ПОРУЧНЯ	81
	LS 614B	Dikd. Küpeşte Ayarlı Dönüş Küresi 0 - 45° + 90° 60 x 25	60x25 MM REGTANGLE RAIL ADJUSTABLE CORNER 0 - 45°	60 x 25 MM УГЛОВОЙ РЕГУЛИРУЕМЫЙ АДАПТЕР ДЛЯ ПРЯМОУГОЛЬНОГО ПОРУЧНЯ 0 - 45° + 90°	81
	LS 801	Dikdörtgen Küpeşte 90° Dönüş	90° ELBOW FOR RECTANGULAR HANDRAIL	УГЛОВОЙ АДАПТЕР 90° ДЛЯ ПРЯМОУГОЛЬНОГО ПРОФИЛЯ	81
	LS 801A	Dikdörtgen Küpeşte 90° Dönüş	90° ELBOW FOR RECTANGULAR HANDRAIL	УГЛОВОЙ АДАПТЕР 90° ДЛЯ ПРЯМОУГОЛЬНОГО ПРОФИЛЯ	81
	LS 801B	90° Köşe Birleşim Sacı 80x30	80x30 90° COENER JOINT PLATE	90° УГЛОВАЯ СОЕДИНИТЕЛЬНАЯ ПЛАСТИНА	81
	LS 801C	90° Köşe Birleşim Sacı 80x30	80x30 90° COENER JOINT PLATE	90° УГЛОВАЯ СОЕДИНИТЕЛЬНАЯ ПЛАСТИНА	81
	LS 801D	90° Köşe Birleşim Destek Sacı	90° COENER JOINT PLATE	90° УГЛОВАЯ СОЕДИНИТЕЛЬНАЯ ОПОРНАЯ ПЛАСТИНА	81
	LS 802	Dikdörtgen Küpeşte 45° Dönüş	45° ELBOW FOR RECTANGULAR HANDRAIL	УГЛОВОЙ АДАПТЕР 45° ДЛЯ ПРЯМОУГОЛЬНОГО ПРОФИЛЯ	82
	LS 802B	45° Köşe Birleşim Sacı 80x30	80x30 45° COENER JOINT PLATE SACI	45° УГЛОВАЯ СОЕДИНИТЕЛЬНАЯ ПЛАСТИНА	82
	LS 802C	45° Köşe Birleşim Sacı 80x30	80x30 45° COENER JOINT PLATE	45° УГЛОВАЯ СОЕДИНИТЕЛЬНАЯ ПЛАСТИНА	82
	LS 804	Dikdörtgen Küpeşte Ayarlı Dönüş Küresi 45° 80x30	ADJUSTABLE ELBOW FOR 80x30 MM RECTANGULAR HANDRAIL	80 x 30 MM УГЛОВОЙ РЕГУЛИРУЕМЫЙ (СФЕРИЧЕСКИЙ) АДАПТЕР 45° ДЛЯ ПРЯМОУГОЛЬНОГО ПОРУЧНЯ	82
	LA 611	Ara Bağlantı	MIDDLE JOINT	ПРОМЕЖУТОЧНОЕ КРЕПЛЕНИЕ	82
	LA 751	Kare Baba Zemin Bağlantı Adaptörü 75 x 75	75x75 MM COLUMN GROUND ADAPTER	75 x 75 MM СОЕДИНИТЕЛЬНЫЙ НАПОЛЬНЫЙ АДАПТЕР ДЛЯ КВАДРАТНОЙ КОЛОННЫ	82
	LA 801	Ara Bağlantı	MIDDLE JOINT	ПРОМЕЖУТОЧНОЕ КРЕПЛЕНИЕ	82









CODE	Ελληνικά	ROMÂNĂ	فارسی	
LS 611B	ΦΥΛΛΟ ΕΝΩΣΗΣ ΓΩΝΙΑΣ 90°	Imbinare 90° pentru rectangulara 60 x 25	پلاک اتصال گوشه 90 درجه بروفیل 60*25	80
LS 612B	ΦΥΛΛΟ ΕΝΩΣΗΣ ΓΩΝΙΑΣ 45°	Imbinare 45° pentru rectangulara 60 x 25	پلاک اتصال گوشه 45 درجه بروفیل 60*25	80
LS 614	60 X 25 ΡΥΘΜΙΖΟΜΕΝΗ ΣΦΑΙΡΑ ΣΤΡΟΦΗΣ ΓΙΑ ΟΡΘΟΓΩΝΙΑ ΚΟΥΠΑΣΤΗ 0 - 90°	Imbinare unghi variabil mana curenta rectangulara 60 x 25 mm unghi 0 - 90°	زاویه قابل تنظیم 0-90 درجه بروفیل 60*25	81
LS 614A	60 X 25 ΡΥΘΜΙΖΟΜΕΝΗ ΣΦΑΙΡΑ ΣΤΡΟΦΗΣ ΓΙΑ ΟΡΘΟΓΩΝΙΑ ΚΟΥΠΑΣΤΗ 0 - 45°	Imbinare unghi variabil mana curenta rectangulara 60 x 25 mm unghi 0 - 45°	انصال بروفیل دسته قابل تنظیم 0-45 درجه برای بروفیل 60*25	81
LS 614B	60 X 25 ΡΥΘΜΙΖΟΜΕΝΗ ΣΦΑΙΡΑ ΣΤΡΟΦΗΣ ΓΙΑ ΟΡΘΟΓΩΝΙΑ ΚΟΥΠΑΣΤΗ 0 - 45° + 90°	Imbinare unghi variabil mana curenta rectangulara 60 x 25 mm unghi 0 - 45° + 90°	انصال بروفیل دسته قابل تنظیم 0-45 و 90 درجه برای بروفیل 60*25	81
LS 801	ΟΡΘΟΓΩΝΙΑ ΚΟΥΠΑΣΤΗ ΣΤΡΟΦΗ 90°	Cot dreptunghiular 90°	زانوی 90 درجه برای بروفیل چهارگوش	81
LS 801A	ΟΡΘΟΓΩΝΙΑ ΚΟΥΠΑΣΤΗ ΣΤΡΟΦΗ 90°	Cot dreptunghiular 90°	زانوی 90 درجه برای بروفیل چهارگوش	81
LS 801B	ΦΥΛΛΟ ΕΝΩΣΗΣ ΓΩΝΙΑΣ 90°	Imbinare 90° pentru 80 x 30 mm	پلاک گوشه 90 درجه برای بروفیل 80*30	81
LS 801C	ΦΥΛΛΟ ΕΝΩΣΗΣ ΓΩΝΙΑΣ 90°	Imbinare 90° pentru 80 x 30 mm	پلاک گوشه 90 درجه برای بروفیل 80*30	81
LS 801D	ΦΥΛΛΟ ΕΝΥΣΧΥΣΗΣ ΕΝΩΣΗΣ ΓΩΝΙΑΣ 90°	Imbinare 90°	پلاک گوشه 90 درجه	81
LS 802	ΟΡΘΟΓΩΝΙΑ ΚΟΥΠΑΣΤΗ ΣΤΡΟΦΗ 45°	Cot dreptunghiular 45°	زانوی 45 درجه برای بروفیل چهارگوش	82
LS 802B	ΦΥΛΛΟ ΕΝΩΣΗΣ ΓΩΝΙΑΣ 45°	Imbinare 45° pentru 80 x 30 mm	پلاک گوشه 45 درجه برای بروفیل 80*30	82
LS 802C	ΦΥΛΛΟ ΕΝΩΣΗΣ ΓΩΝΙΑΣ 45°	Imbinare 45° pentru 80 x 30 mm	پلاک گوشه 45 درجه برای بروفیل 80*30	82
LS 804	80 X 30 ΡΥΘΜΙΖΟΜΕΝΗ ΣΦΑΙΡΑ ΣΤΡΟΦΗΣ ΓΙΑ ΟΡΘΟΓΩΝΙΑ ΚΟΥΠΑΣΤΗ 45°	Cot sferic ajustabil 45° pentru piese dreptunghiulare de 80x30 mm	زانوی قابل تنظیم برای بروفیل 80*30	82
LA 611	ΕΝΔΙΑΜΕΣΗ ΣΥΝΔΕΣΗ	Piesa interconectare	اتصال وسط	82
LA 751	ΠΡΟΣΑΡΜΟΓΕΑΣ ΔΙΠΕΔΟΥ ΤΕΤΡΑΓΩΝΗΣ ΣΤΗΛΗΣ 75 X 75	Adaptor patrat cu conectare la sol 75x75 mm	محافظ اتصال ستون 75*75 میلی متری	82
LA 801	ΕΝΔΙΑΜΕΣΗ ΣΥΝΔΕΣΗ	Piesa interconectare	اتصال وسط	82





















miniprofiles









miniprofiller





Code/Kod	Drawing/Çizim	Theoretical Weight kg/m Teorik Ağırlık kg/m
10-128-025	 Ø50x2.5	1.011
10-128-020	 Ø50x2	0.817
10-128-015	 Ø50x1.5	0.619
10-124-025	 Ø40x2.5	0.798
10-122-025	 Ø35x2.5	0.692
10-119-030	 Ø30x3	0.689
10-119-025	 Ø30x2.5	0.585
10-119-022	 Ø30x2.2	0.521
10-103-040	 Ø16x4	0.408

Code/Kod	Drawing/Çizim	Theoretical Weight kg/m Teorik Ağırlık kg/m
10-103-020	 Ø16x2	0.238
10-103-050	 Ø16x5	0.467
10-103-015	 Ø16x1.5	0.185
12-141-020R	 Ø12x12x2	0.211
12-153-020R	 Ø14x14x2	0.258
12-133-013	 Ø50x12x1.3	0.418
13-104-030	 Ø20x3	0.163
18-101-023	 Ø40x2.3	1.219
18-102-020	 Ø40x2	1.050

Code/Kod	Drawing/Çizim	Theoretical Weight kg/m Teorik Ağırlık kg/m
18-103-015	 Ø40x1.5	0.904
18-104-023	 Ø40x2.3	0.945
18-105-020	 Ø40x2	0.848
18-106-016	 Ø40x1.6	0.718
18-107-020	 Ø40x2	0.896
18-108-018	 Ø40x1.8	0.853
18-113-023	 Ø40x2.3	1.142
18-114-016	 Ø40x1.6	1.065
18-126-015	 Ø40x1.5	0.895

Code/Kod	Drawing/Çizim	Theoretical Weight kg/m Teorik Ağırlık kg/m
18-112-025	 Ø50x2.5	1.652
18-109-018	 Ø30x1.8	0.621
18-301-00	 Ø66x3	1.380
18-110-015	 Ø25x1.5	0.354
18-111-015	 Ø30x1.5	0.415
18-123-015	 Ø30x1.5	0.457
18-201-00		0.059
18-202-00		0.067
18-203-00		0.075

Code/Kod	Drawing/Çizim	Theoretical Weight kg/m Teorik Ağırlık kg/m
18-204-00		0.059
18-205-00		0.112
18-209-00		0.081
18-302-025	 Ø50x2.5	1.282
18-303-025	 Ø60x2.5	1.494
18-306-00		5.262
18-308-013		0.295
18-309-013		0.198
18-117-020	 50x2	1.367

Code/Kod	Drawing/Çizim	Theoretical Weight kg/m Teorik Ağırlık kg/m
18-118-020	 50x2	1.204
18-124-00		1.398
18-311-00		3.894
18-312-00		6.689
18-313-017	 Ø50x1.7	1.040

Square & Rectangular Handrails
Kare ve Dikdörtgen Küpeřteler



Code/Kod	Drawing/Çizim	Theoretical Weight kg/m Teorik Ağırlık kg/m
18-119-020	 80x30x2	1.355
18-120-020	 80x30x2	1.606
18-127-018	 60x25x1.8	1.108
18-128-018	 60x25x1.8	0.921
18-121-00	 50x25x2.3	1.026
18-129-00	 50x25x2.3	1.150
18-122-00	 30x25x1.8	0.508
18-116-015	 40x40x1.5	1.092
18-115-015	 40x40x1.5	0.990

Code/Kod	Drawing/Çizim	Theoretical Weight kg/m Teorik Ağırlık kg/m
18-125-016	 75x75x1.6	1.423
18-207-00	 75x75x1.6	0.064
18-208-00	 75x75x1.6	0.171
18-206-00	 75x75x1.6	0.058

Aluminium Design Gürsan Reserved
Tasarım Gürsan Alüminyum'a aittir.

The image features a series of curved, overlapping bands in various shades of gray and white, creating a sense of depth and movement. The bands are separated by thin white lines. The overall composition is minimalist and modern.

profiles

profiller

CODE / KOD

10-128-025

**THEORETICAL
WEIGHT kg/m**

TEORİK AĞIRLIK kg/m

1.011

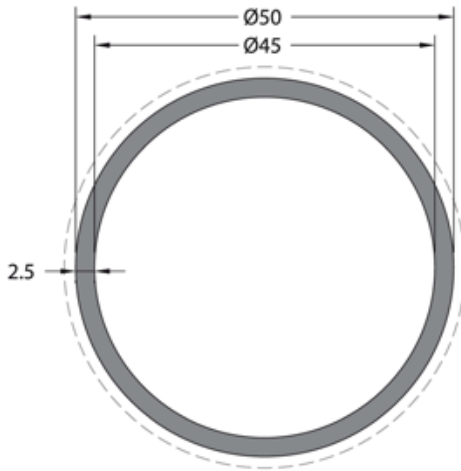

CODE / KOD

10-124-025

**THEORETICAL
WEIGHT kg/m**

TEORİK AĞIRLIK kg/m

0.798

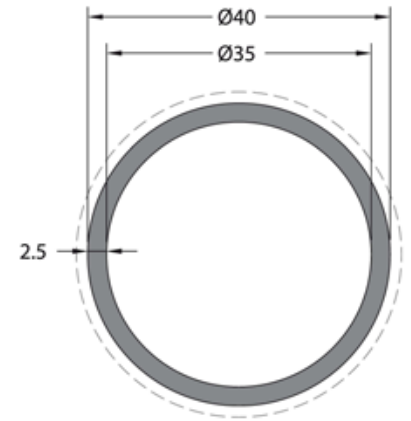

CODE / KOD

10-128-020

**THEORETICAL
WEIGHT kg/m**

TEORİK AĞIRLIK kg/m

0.817

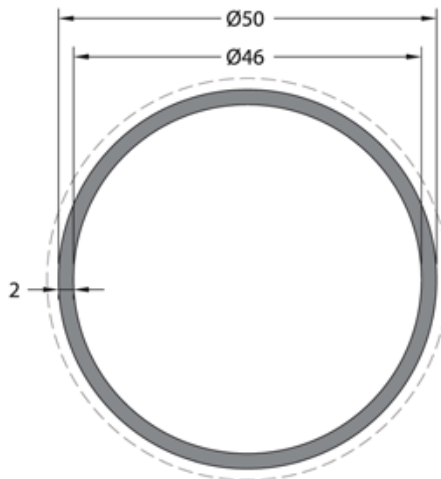

CODE / KOD

10-122-025

**THEORETICAL
WEIGHT kg/m**

TEORİK AĞIRLIK kg/m

0.692

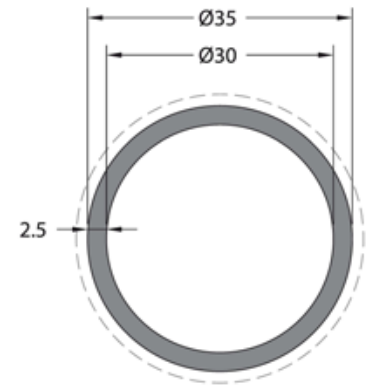

CODE / KOD

10-128-015

**THEORETICAL
WEIGHT kg/m**

TEORİK AĞIRLIK kg/m

0.619

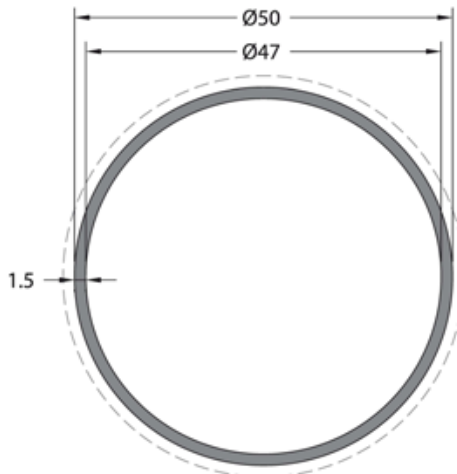

CODE / KOD

10-119-030

**THEORETICAL
WEIGHT kg/m**

TEORİK AĞIRLIK kg/m

0.689

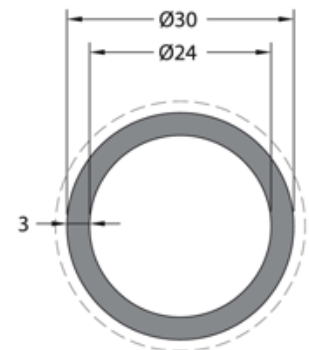

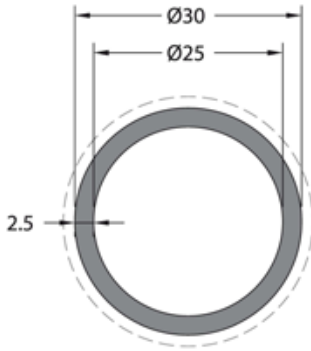

CODE / KOD
10-119-025
THEORETICAL WEIGHT kg/m
 TEORİK AĞIRLIK kg/m
0.585

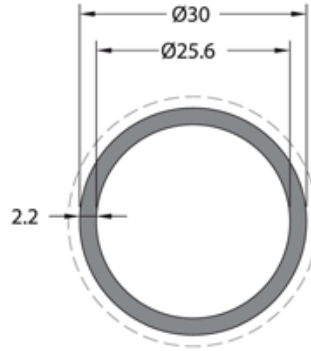

CODE / KOD
10-119-022
THEORETICAL WEIGHT kg/m
 TEORİK AĞIRLIK kg/m
0.521

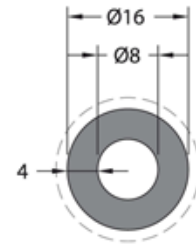

CODE / KOD
10-103-040
THEORETICAL WEIGHT kg/m
 TEORİK AĞIRLIK kg/m
0.408

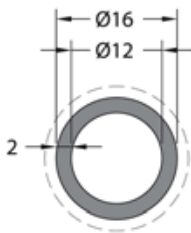

CODE / KOD
10-103-020
THEORETICAL WEIGHT kg/m
 TEORİK AĞIRLIK kg/m
0.238

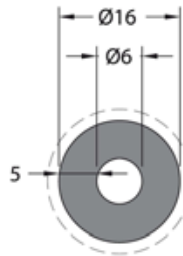

CODE / KOD
10-103-050
THEORETICAL WEIGHT kg/m
 TEORİK AĞIRLIK kg/m
0.467

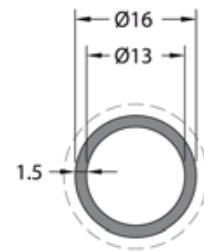

CODE / KOD
10-103-015
THEORETICAL WEIGHT kg/m
 TEORİK AĞIRLIK kg/m
0.185

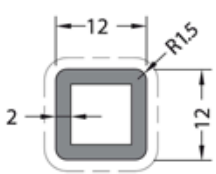

CODE / KOD
12-141-020R
THEORETICAL WEIGHT kg/m
 TEORİK AĞIRLIK kg/m
0.211

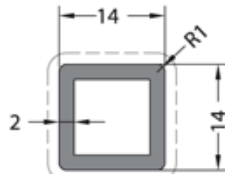

CODE / KOD
12-153-020R
THEORETICAL WEIGHT kg/m
 TEORİK AĞIRLIK kg/m
0.258

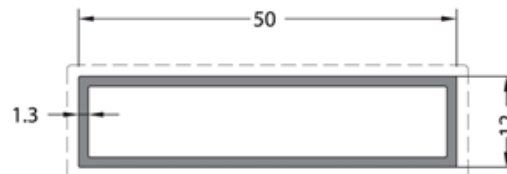

CODE / KOD
12-133-013
THEORETICAL WEIGHT kg/m
 TEORİK AĞIRLIK kg/m
0.418

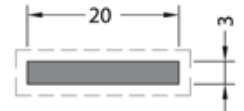

CODE / KOD
13-104-030
THEORETICAL WEIGHT kg/m
 TEORİK AĞIRLIK kg/m
0.163

CODE / KOD

18-101-023

THEORETICAL
WEIGHT kg/m

TEORİK AĞIRLIK kg/m

1.219

APPLICATION PROFILE

UYGULAMA PROFİLİ

18-201-00

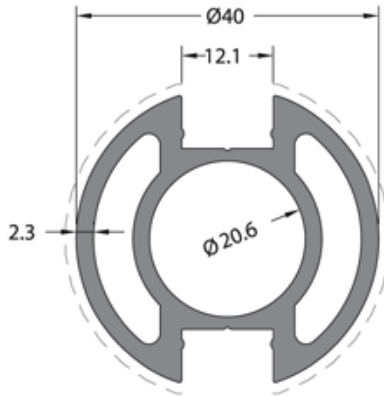

CODE / KOD

18-102-020

THEORETICAL
WEIGHT kg/m

TEORİK AĞIRLIK kg/m

1.050

APPLICATION PROFILE

UYGULAMA PROFİLİ

18-201-00

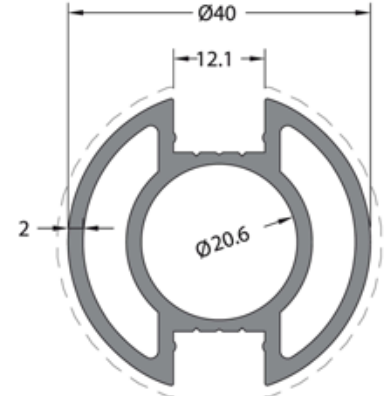

CODE / KOD

18-103-015

THEORETICAL
WEIGHT kg/m

TEORİK AĞIRLIK kg/m

0.904

APPLICATION PROFILE

UYGULAMA PROFİLİ

18-201-00

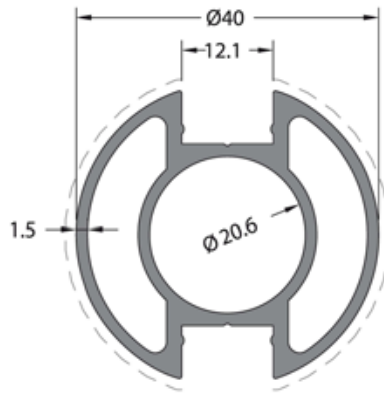

CODE / KOD

18-104-023

THEORETICAL
WEIGHT kg/m

TEORİK AĞIRLIK kg/m

0.945

APPLICATION PROFILE

UYGULAMA PROFİLİ

18-201-00

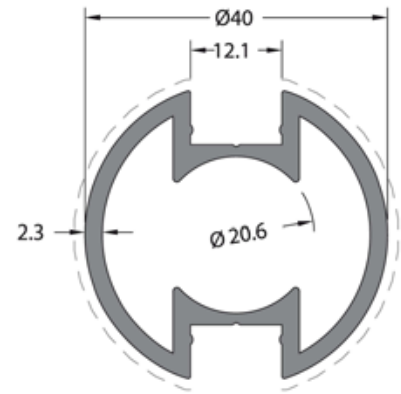

CODE / KOD

18-105-020

THEORETICAL
WEIGHT kg/m

TEORİK AĞIRLIK kg/m

0.848

APPLICATION PROFILE

UYGULAMA PROFİLİ

18-201-00

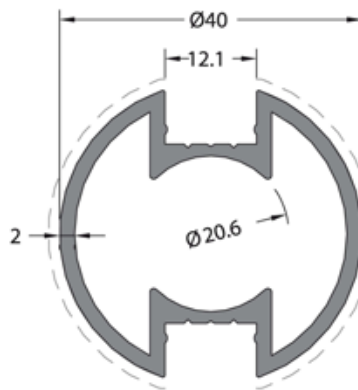

CODE / KOD

18-106-016

THEORETICAL
WEIGHT kg/m

TEORİK AĞIRLIK kg/m

0.718

APPLICATION PROFILE

UYGULAMA PROFİLİ

18-201-00

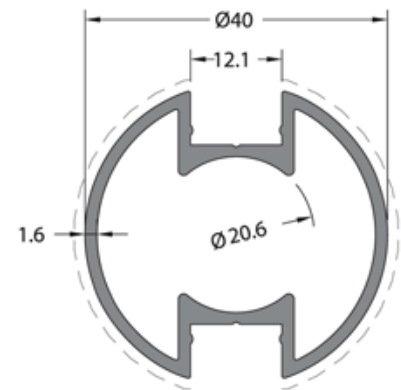

CODE / KOD

18-107-020

THEORETICAL
WEIGHT kg/m

TEORİK AĞIRLIK kg/m

0.896

APPLICATION PROFILE
UYGULAMA PROFİLİ

18-202-00

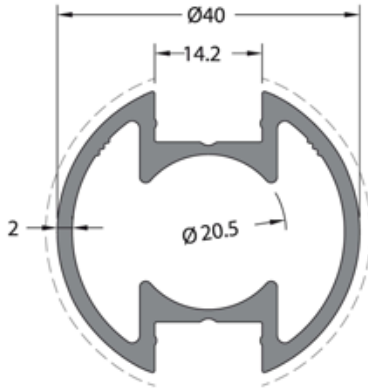

CODE / KOD

18-108-018

THEORETICAL
WEIGHT kg/m

TEORİK AĞIRLIK kg/m

0.853

APPLICATION PROFILE

18-201-00

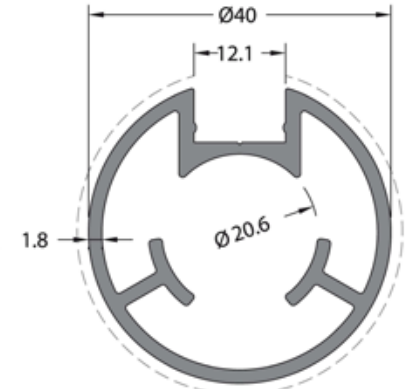

CODE / KOD

18-113-023

THEORETICAL
WEIGHT kg/m

TEORİK AĞIRLIK kg/m

1.142

APPLICATION PROFILE
UYGULAMA PROFİLİ

18-201-00

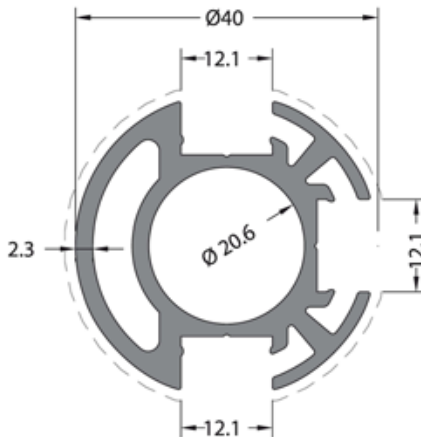

CODE / KOD

18-114-016

THEORETICAL
WEIGHT kg/m

TEORİK AĞIRLIK kg/m

1.065

APPLICATION PROFILE

18-201-00

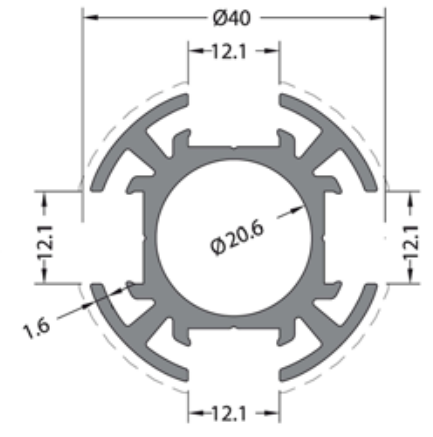

CODE / KOD

18-126-015

THEORETICAL
WEIGHT kg/m

TEORİK AĞIRLIK kg/m

0.895

APPLICATION PROFILE
UYGULAMA PROFİLİ

18-201-00

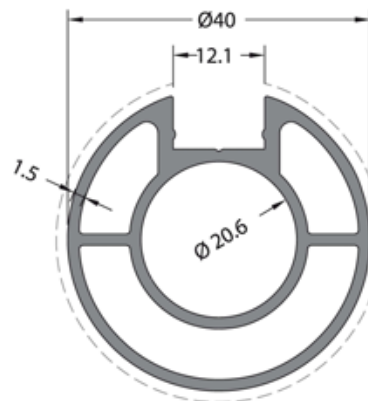

CODE / KOD

18-112-025

THEORETICAL
WEIGHT kg/m

TEORİK AĞIRLIK kg/m

1.652

APPLICATION PROFILE

18-205-00

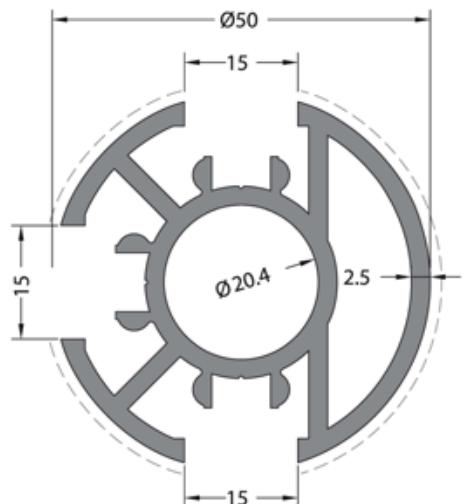

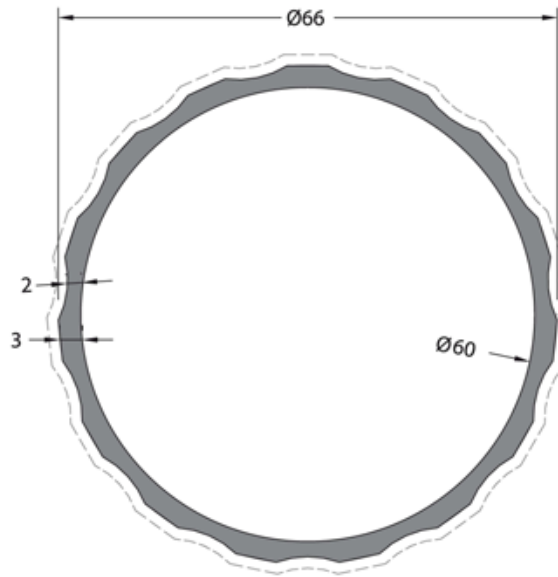

CODE / KOD

18-301-00

**THEORETICAL
WEIGHT kg/m**

TEORİK AĞIRLIK kg/m

1.380

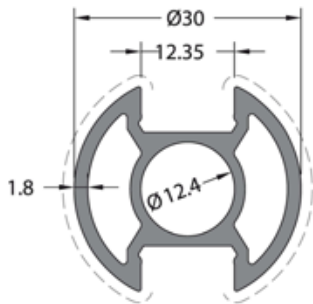

CODE / KOD

18-109-018

**THEORETICAL
WEIGHT kg/m**

TEORİK AĞIRLIK kg/m

0.621

APPLICATION PROFILE

UYGULAMA PROFİLİ

18-204-00

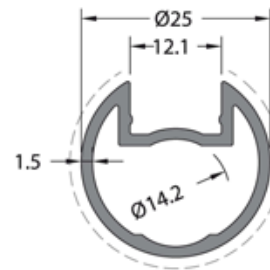

CODE / KOD

18-110-015

**THEORETICAL
WEIGHT kg/m**

TEORİK AĞIRLIK kg/m

0.354

APPLICATION PROFILE

UYGULAMA PROFİLİ

18-201-00



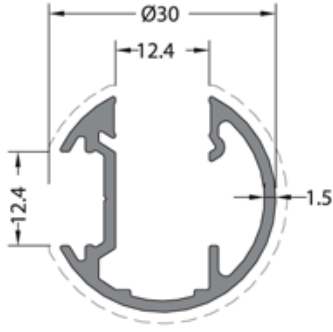

CODE / KOD
18-111-015

THEORETICAL WEIGHT kg/m
TEORİK AĞIRLIK kg/m
0.415

APPLICATION PROFILE
UYGULAMA PROFİLİ

18-203-00



18-204-00

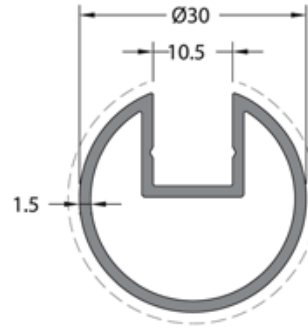

CODE / KOD
18-123-015

THEORETICAL WEIGHT kg/m
TEORİK AĞIRLIK kg/m
0.457

APPLICATION PROFILE
UYGULAMA PROFİLİ

18-209-00

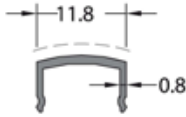

CODE / KOD
18-201-00
THEORETICAL WEIGHT kg/m
TEORİK AĞIRLIK kg/m
0.059

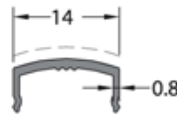

CODE / KOD
18-202-00
THEORETICAL WEIGHT kg/m
TEORİK AĞIRLIK kg/m
0.067

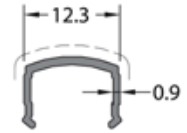

CODE / KOD
18-203-00
THEORETICAL WEIGHT kg/m
TEORİK AĞIRLIK kg/m
0.075

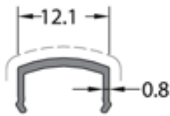

CODE / KOD
18-204-00
THEORETICAL WEIGHT kg/m
TEORİK AĞIRLIK kg/m
0.059

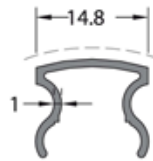

CODE / KOD
18-205-00
THEORETICAL WEIGHT kg/m
TEORİK AĞIRLIK kg/m
0.112

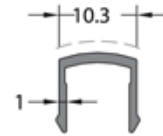

CODE / KOD
18-209-00
THEORETICAL WEIGHT kg/m
TEORİK AĞIRLIK kg/m
0.081

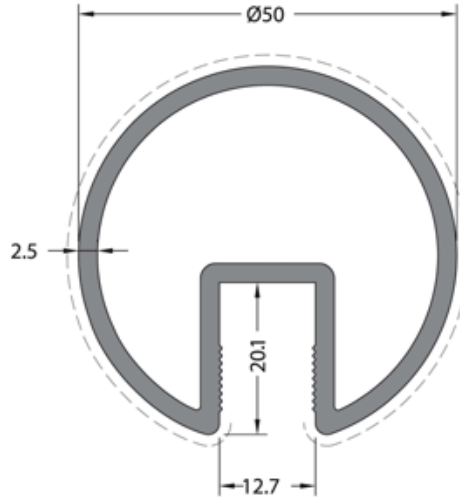

CODE / KOD

18-302-025

**THEORETICAL
WEIGHT kg/m**

TEORİK AĞIRLIK kg/m

1.282

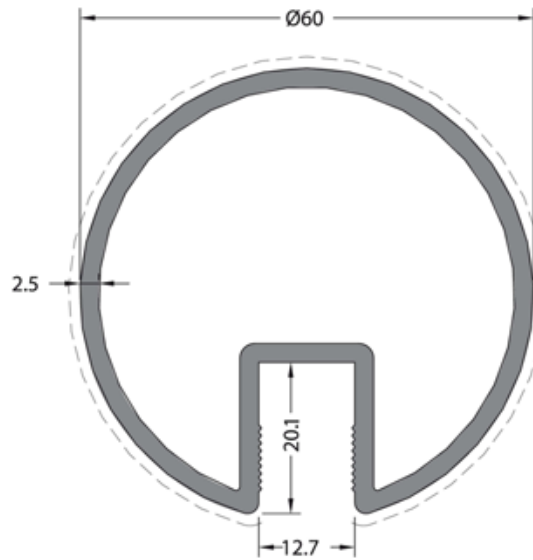

CODE / KOD

18-303-025

**THEORETICAL
WEIGHT kg/m**

TEORİK AĞIRLIK kg/m

1.494

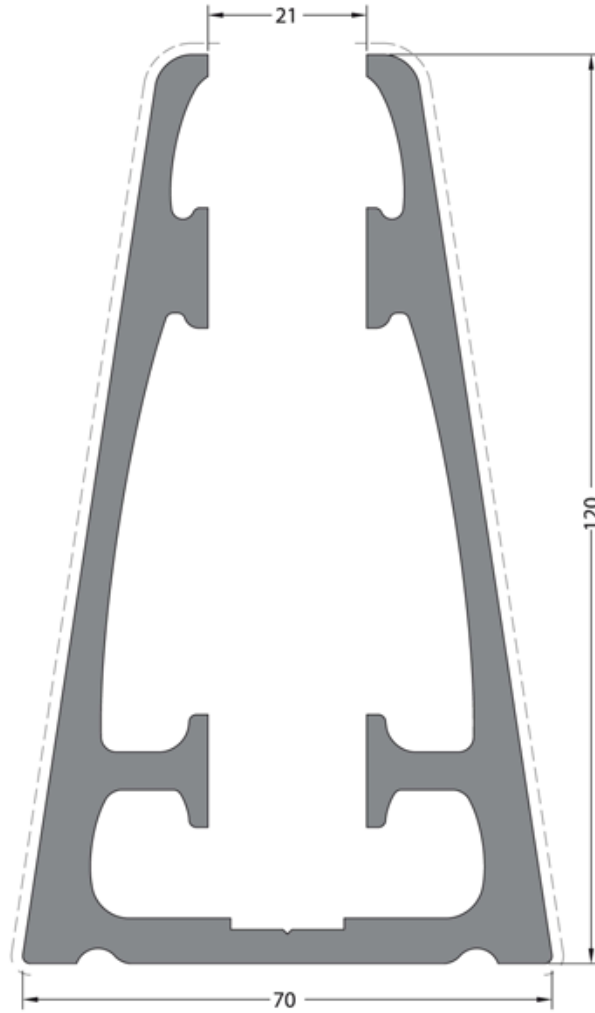

CODE / KOD

18-306-00

**THEORETICAL
WEIGHT kg/m**

TEORİK AĞIRLIK kg/m

5.262

handrail profiles / küpeşteprofilleri

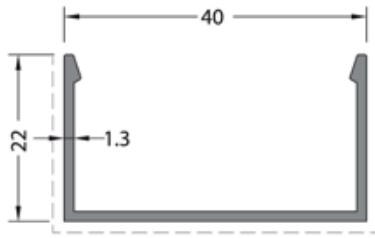

CODE / KOD
18-308-013 **THEORETICAL**
WEIGHT kg/m
TEORİK AĞIRLIK kg/m
0.295

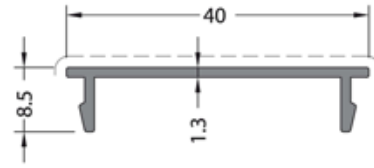

CODE / KOD
18-309-013 **THEORETICAL**
WEIGHT kg/m
TEORİK AĞIRLIK kg/m
0.198

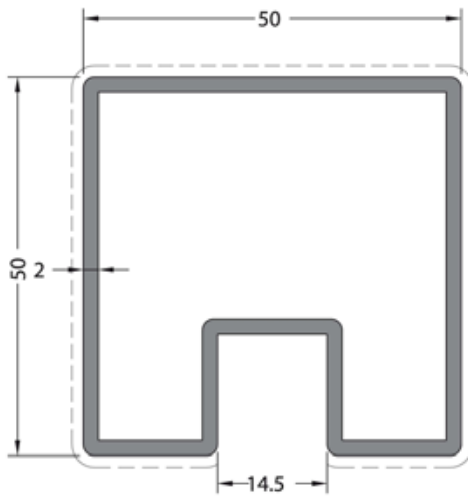

CODE / KOD
18-118-020 **THEORETICAL**
WEIGHT kg/m
TEORİK AĞIRLIK kg/m
1.204

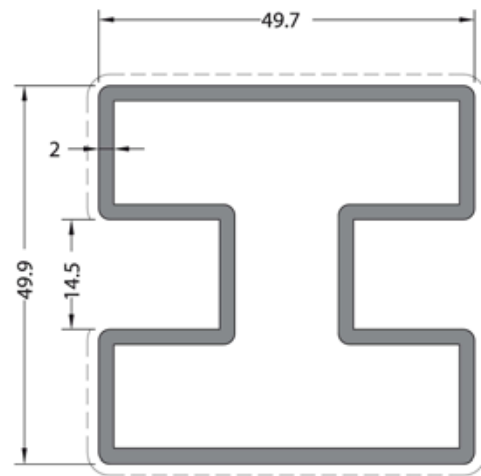

CODE / KOD
18-117-020 **THEORETICAL**
WEIGHT kg/m
TEORİK AĞIRLIK kg/m
1.367

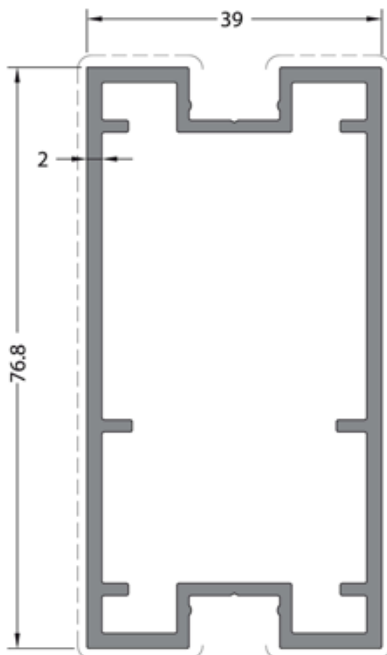

CODE / KOD
18-124-00 **THEORETICAL**
WEIGHT kg/m
TEORİK AĞIRLIK kg/m
1.398

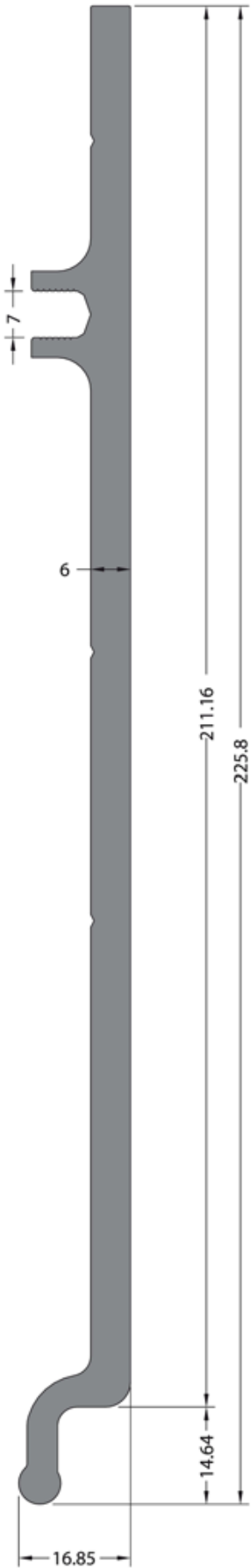

CODE / KOD
18-311-00
THEORETICAL WEIGHT kg/m
 TEORİK AĞIRLIK kg/m
3.894

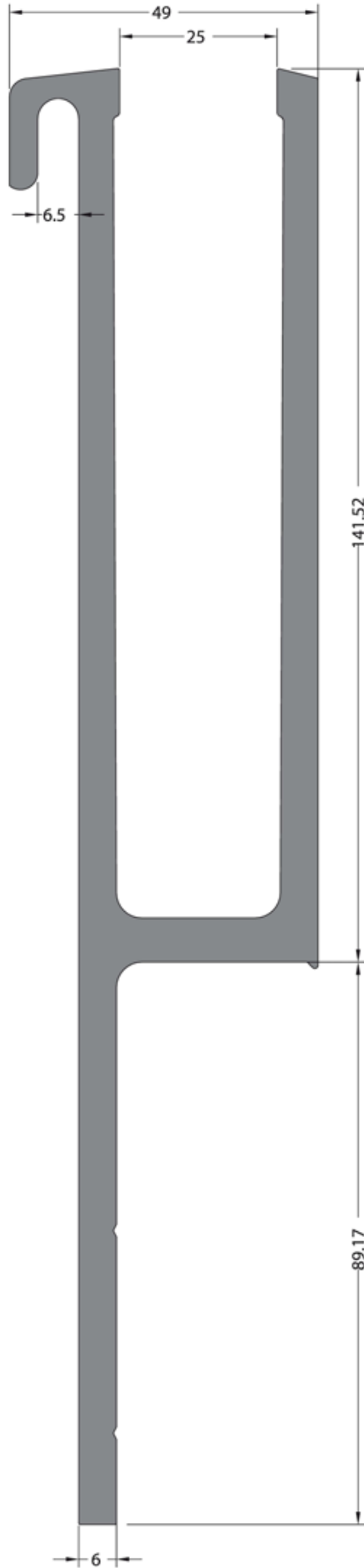

CODE / KOD
18-312-00
THEORETICAL WEIGHT kg/m
 TEORİK AĞIRLIK kg/m
6.689

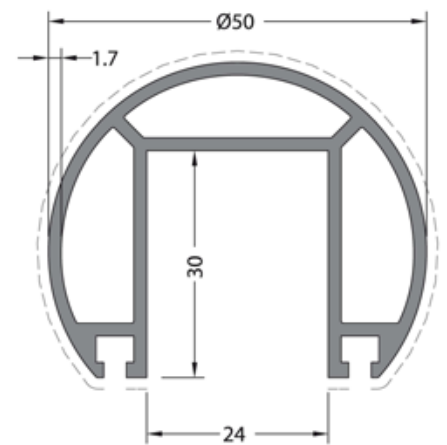

CODE / KOD
18-313-017
THEORETICAL WEIGHT kg/m
 TEORİK AĞIRLIK kg/m
1.040



Square & Rectangular Handrails Kare ve Dikdörtgen Küpeşteler

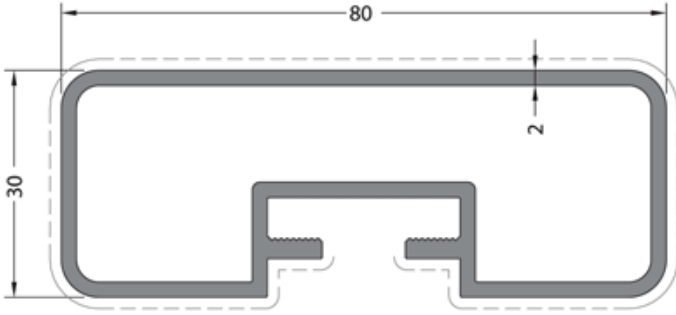

CODE / KOD
18-119-020
THEORETICAL WEIGHT kg/m
TEORİK AĞIRLIK kg/m
1.355

APPLICATION PROFILE
UYGULAMA PROFİLİ
18-208-00

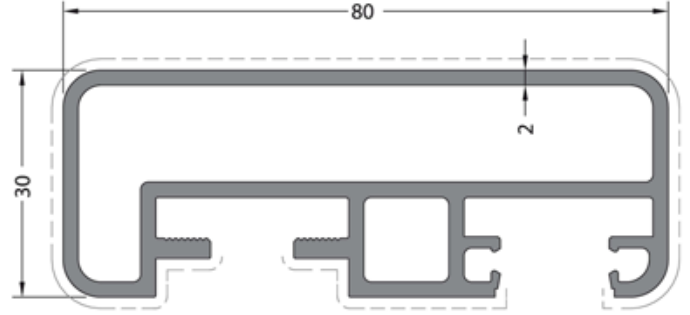

CODE / KOD
18-120-020
THEORETICAL WEIGHT kg/m
TEORİK AĞIRLIK kg/m
1.606

APPLICATION PROFILE
UYGULAMA PROFİLİ
18-208-00



18-207-00

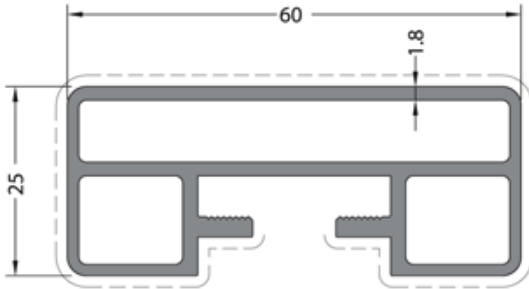

CODE / KOD
18-127-018
THEORETICAL WEIGHT kg/m
TEORİK AĞIRLIK kg/m
1.108

APPLICATION PROFILE
UYGULAMA PROFİLİ
18-208-00

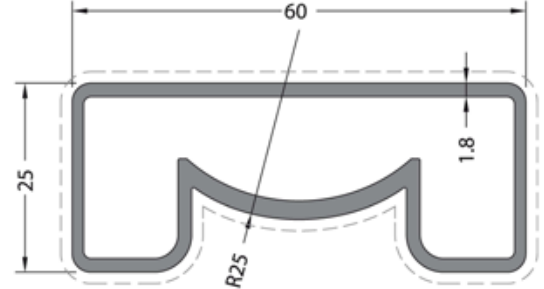

CODE / KOD
18-128-018
THEORETICAL WEIGHT kg/m
TEORİK AĞIRLIK kg/m
0.921

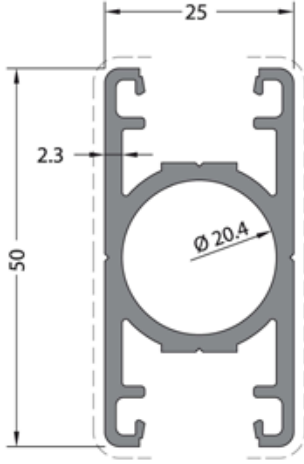

CODE / KOD

18-121-00

THEORETICAL WEIGHT kg/m

TEORİK AĞIRLIK kg/m

1.026

APPLICATION PROFILE

UYGULAMA PROFİLİ

18-207-00

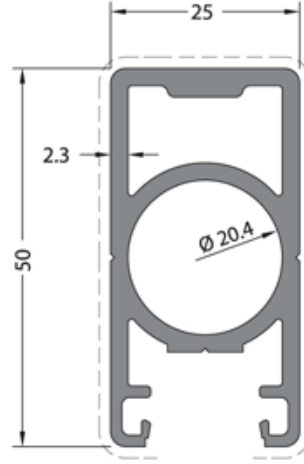

CODE / KOD

18-129-00

THEORETICAL WEIGHT kg/m

TEORİK AĞIRLIK kg/m

1.150

APPLICATION PROFILE

UYGULAMA PROFİLİ

18-207-00

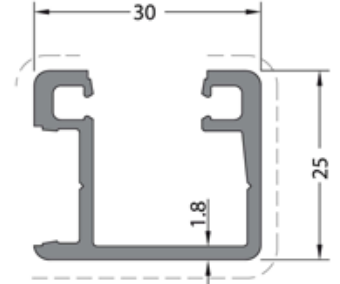

CODE / KOD

18-122-00

THEORETICAL WEIGHT kg/m

TEORİK AĞIRLIK kg/m

0.508

APPLICATION PROFILE

UYGULAMA PROFİLİ

18-207-00

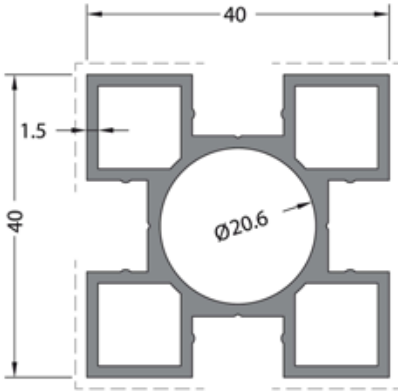

CODE / KOD

18-116-015

THEORETICAL WEIGHT kg/m

TEORİK AĞIRLIK kg/m

1.092

APPLICATION PROFILE

UYGULAMA PROFİLİ

18-206-00

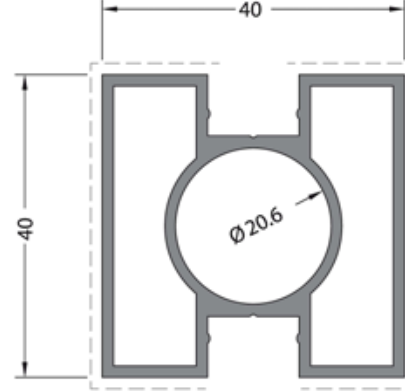

CODE / KOD

18-115-015

THEORETICAL WEIGHT kg/m

TEORİK AĞIRLIK kg/m

0.990

APPLICATION PROFILE

UYGULAMA PROFİLİ

18-206-00



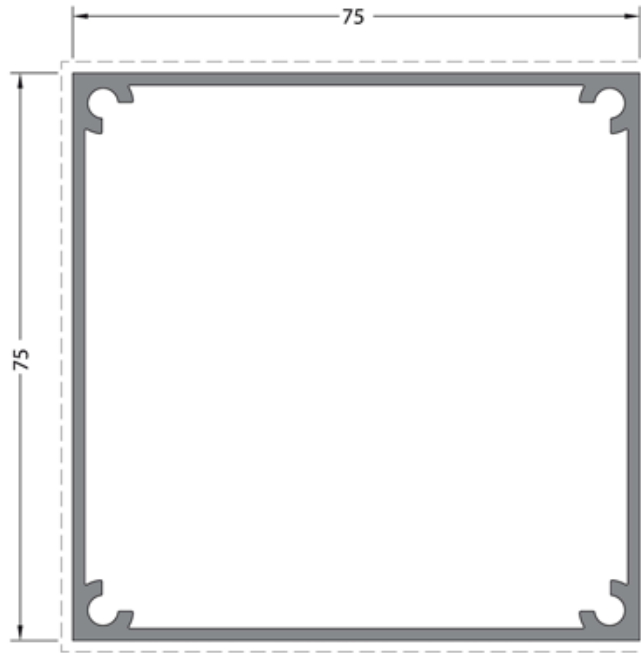

CODE / KOD
18-125-016
THEORETICAL
WEIGHT kg/m
TEORİK AĞIRLIK kg/m
1.423

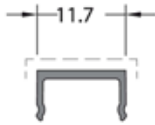

CODE / KOD
18-206-00
THEORETICAL
WEIGHT kg/m
TEORİK AĞIRLIK kg/m
0.058

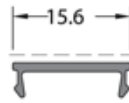

CODE / KOD
18-207-00
THEORETICAL
WEIGHT kg/m
TEORİK AĞIRLIK kg/m
0.064

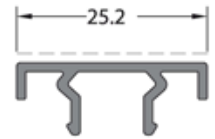

CODE / KOD
18-208-00
THEORETICAL
WEIGHT kg/m
TEORİK AĞIRLIK kg/m
0.171

accessories

aksesuarlar

LR11-161

16mm External Screwed Flange
16'lık Dıştan Vidalı Flanş

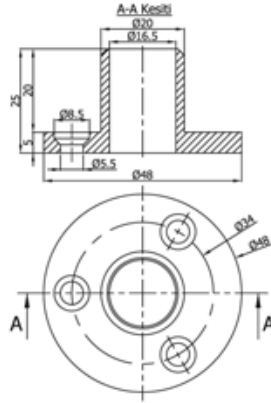
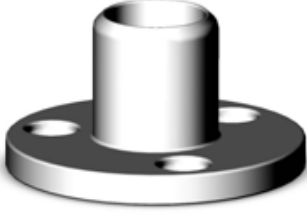

LR11-501

50mm External Screwed Flange
50'lık Dıştan Vidalı Flanş

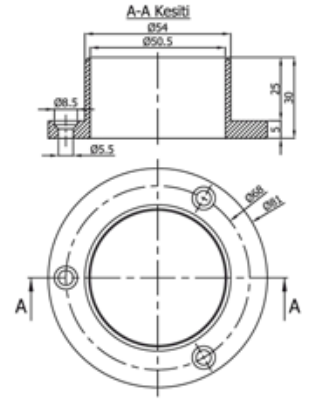

LR11-301

30mm External Screwed Flange
30'lık Dıştan Vidalı Flanş

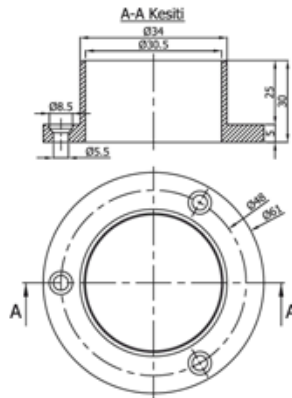

LR11-502

50mm External Screwed Flange Long
50'lık Dıştan Vidalı Flanş Uzun

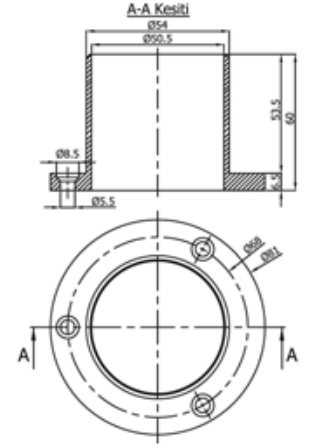
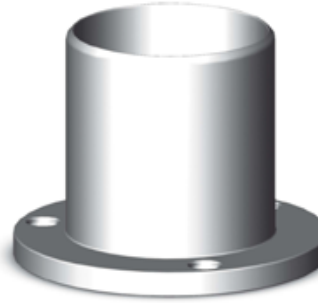

LR11-401

40mm External Screwed Flange
40'lık Dıştan Vidalı Flanş

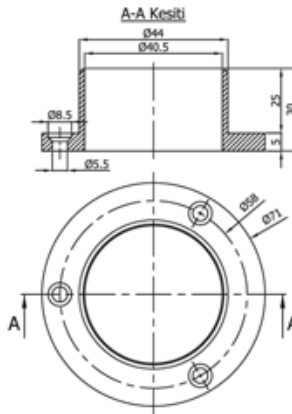
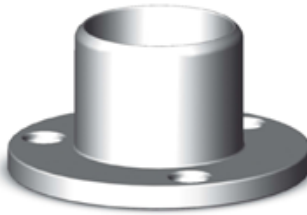

LR10-503

50mm Decorative Flange (Without Pin)
50'lık Dekoratif Flanş (Tirmaksız)

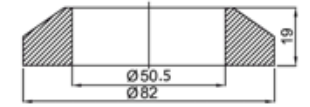

LR11-402

40mm External Screwed Flange Long
40'lık Dıştan Vidalı Flanş Uzun

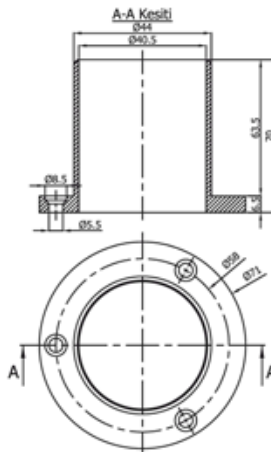

LR11-601

60mm External Screwed Flange
60'lık Dıştan Vidalı Flanş

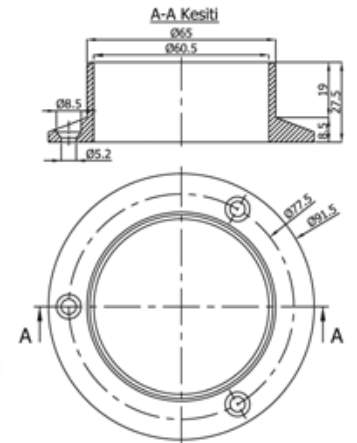

LR12-401

40mm Strut Flange
40'lık Dikme Flaşı (Çift Tırnaklı)

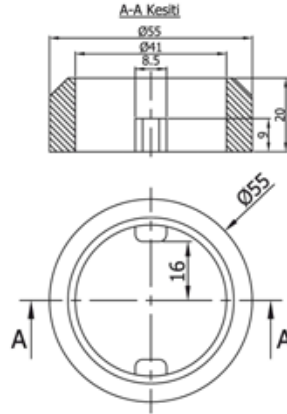

LR12-405

40mm Strut Flange (Without Pin)
40'lık Dikme Flaşı (Tırnaksız)

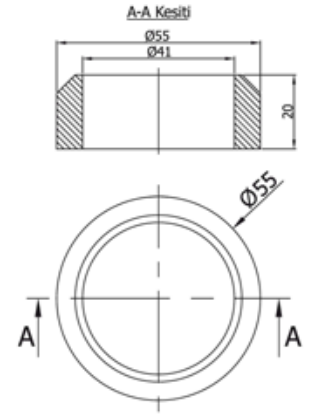

LR12-402

40mm Strut Flange Long
40'lık Dikme Flaşı Uzun

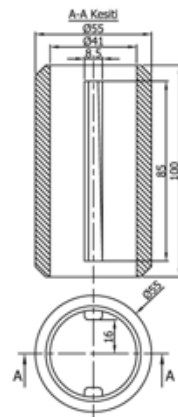

LR12-406

40mm Decorative Flange (Without Pin)
40'lık Dikme Flaşı (Tırnaksız)

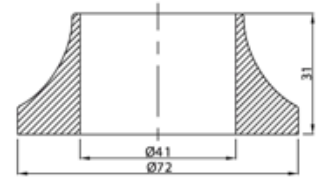

LR12-403

40mm Decorative Flange
40'lık Dekorlu Dikme Flaşı

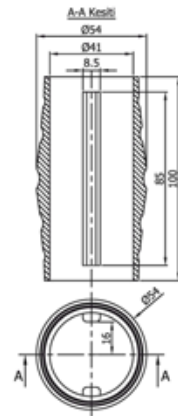

LR13-161

16mm Pipe Flange
16'lık Boru Flaşı

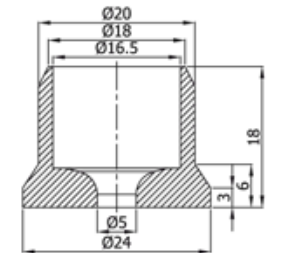

LR12-404

40mm Strut Flange (Single Pin)
40'lık Dikme Flaşı (Tek Tırnaklı)

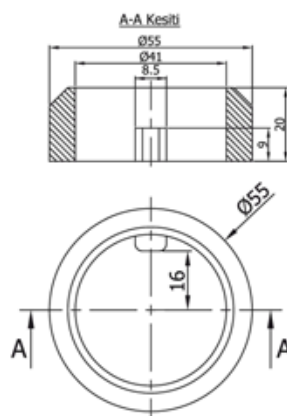

LR13-301

30mm Pipe Flange
30'lık Boru Flaşı

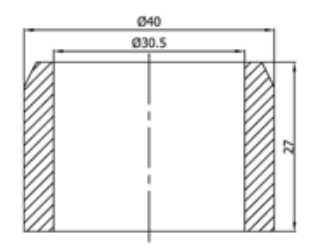

LR13-302

30mm Long Pipe Flange
30'luk Uzun Boru Flaşı

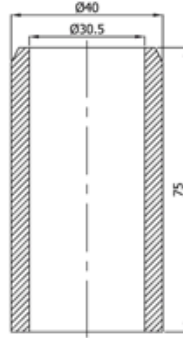

LR13-303

30mm Decorated Pipe Flange
30'luk Dekorlu Boru Flaşı

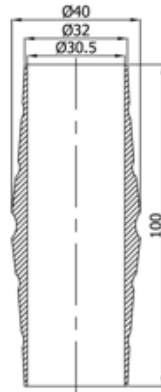

LR13-304

30mm Pipe Flange
30'luk Boru Flaşı

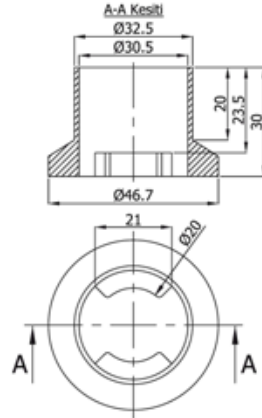

LR13-401

40mm Pipe Flange
40'luk Boru Flaşı

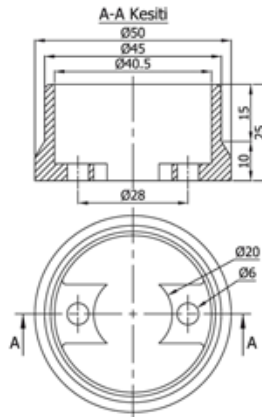

LR13-501

50mm Pipe Flange
50'luk Boru Flaşı

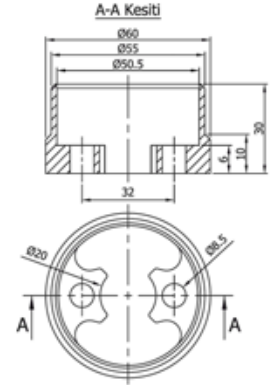

LR13-502

50mm Pipe Flange Long
50'luk Boru Flaşı Uzun

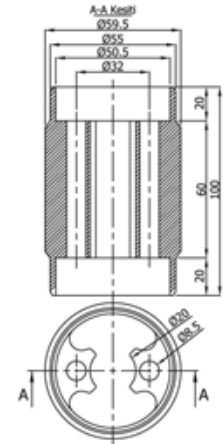

LR13-503

50mm Flange
50'luk Yer Dibi Flaşı

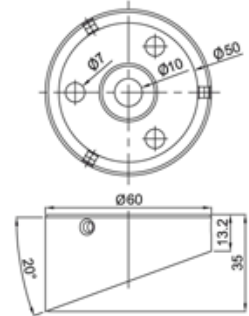

LR13-601

60mm Pipe Flange
60'luk Boru Flaşı

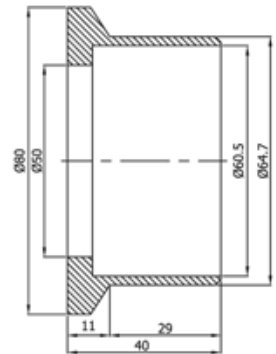
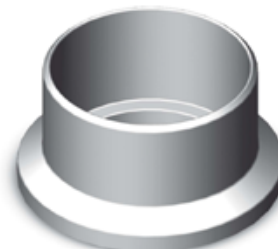

LR13-701

70mm Perforated Pipe
70'lik Tırtıllı Boru

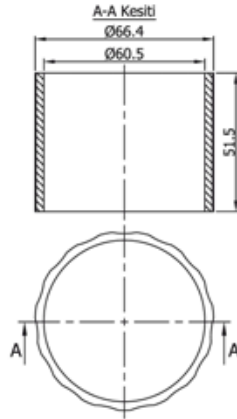

LR13-702

70mm Decorated Flange
70'lik Dekorlu Flanş

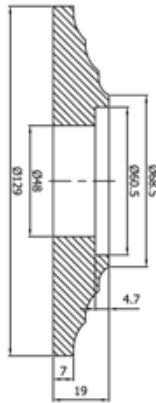

LR14-401

40mm External Screwed Flange Cap Interlaced
40'lik Dıştan Vidalı Flanş Kapağı Geçmeli

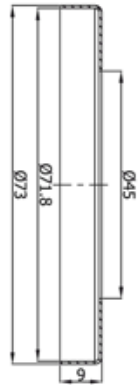

LR14-501

50mm External Screwed Flange Cap Interlaced
50'lik Dıştan Vidalı Flanş Kapağı Geçmeli

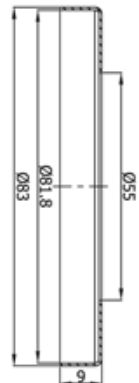

LR16-351

35mm System Strut Flange
35'lik Sistem Dikme Flanşı

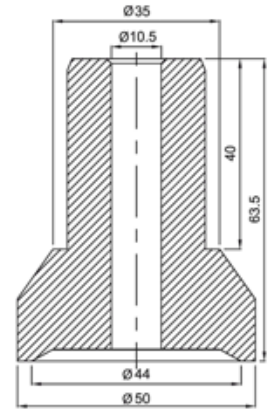

LR17-401

40mm Decorative Flange
40'lik Dekoratif Flanş

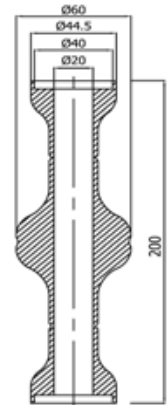

LR21-351

50mm Crescent Connection to 35mm Strut (35x50)
35'lik Dikmeye 50'lik Ay Bağlantı (35x50)

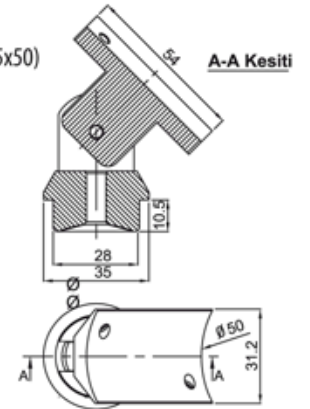

LR21-301

40mm Crescent Connection to 30mm Strut (30x40)
30'luk Dikmeye 40'lik Ay Bağlantı (30x40)

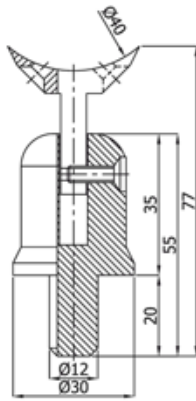

LR21-401

40mm Crescent Connection to 40mm Strut (40x40)
40'lik Dikmeye 40'lik Ay Bağlantı (40x40)

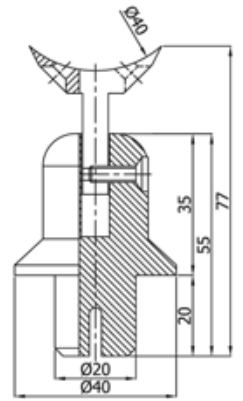

LR21-302

40mm Crescent Connection to 30mm Pipe (30x40)
30'luk Boruya 40'lik Ay Bağlantı (30x40)

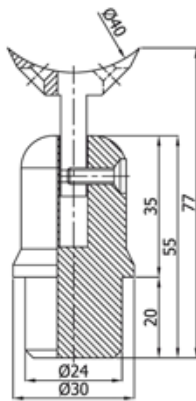

LR21-402

40mm Crescent Connection to 40mm Pipe (40x40)
40'lik Boruya 40'lik Ay Bağlantı (40x40)

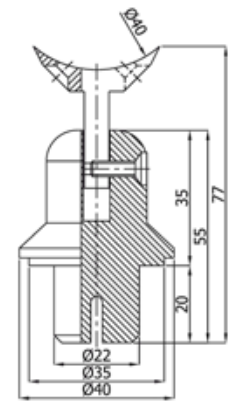

LR21-303

50mm Crescent Connection to 30mm Strut (30x50)
30'luk Dikmeye 50'lik Ay Bağlantı (30x50)

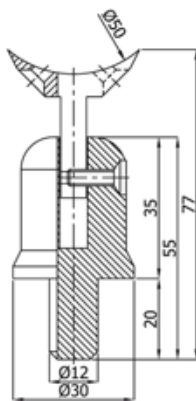

LR21-403

50mm Crescent Connection to 40mm Strut (40x50)
40'lik Dikmeye 50'lik Ay Bağlantı (40x50)

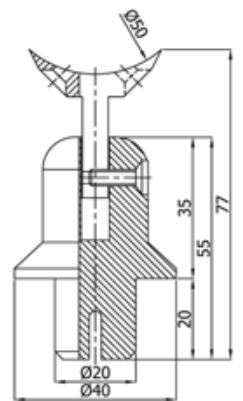

LR21-304

50mm Crescent Connection to 30mm Pipe (30x50)
30'luk Boruya 50'lik Ay Bağlantı (30x50)

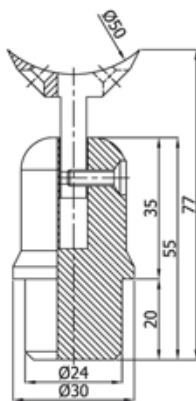

LR21-404

50mm Crescent Connection to 40mm Pipe (40x50)
40'lik Boruya 50'lik Ay Bağlantı (40x50)

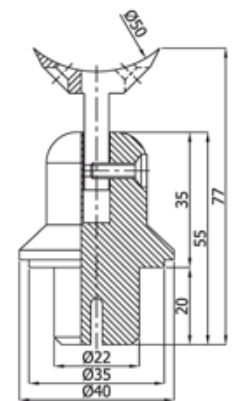

LR31-201

20mm Ring
20'lik Bilezik

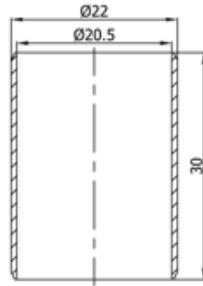

LR31-301

30mm Ring
30'luk Bilezik

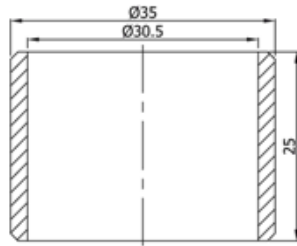

LR31-401

40mm Ring
40'lik Bilezik

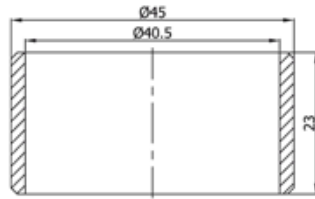

LR31-501

50mm Ring
50'lik Bilezik

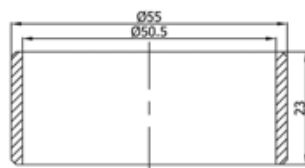

LR31-502

50mm Long Ring
50'lik Uzun Bilezik

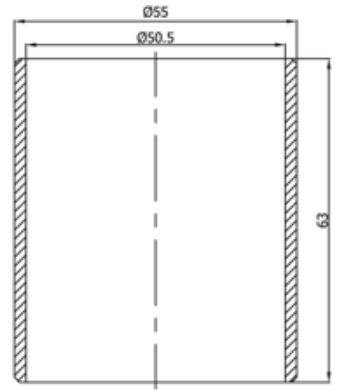

LR31-601

60mm Ring
60'lik Bilezik

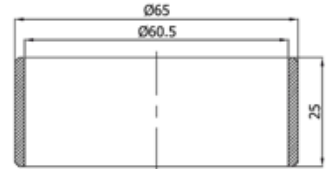

LR32-401

40mm Ceiling Clamp to Strut
40'lik Dikmeye Tavan Bileziği

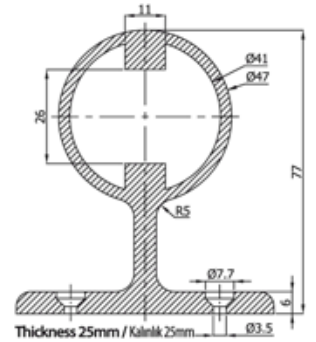

LR32-402

40mm Ceiling Clamp to Pipe
40'lik Boruya Tavan Bileziği

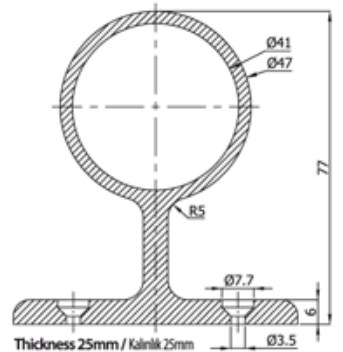

LR32-501

50mm Ceiling Clamp
50'lik Tavan Bileziği

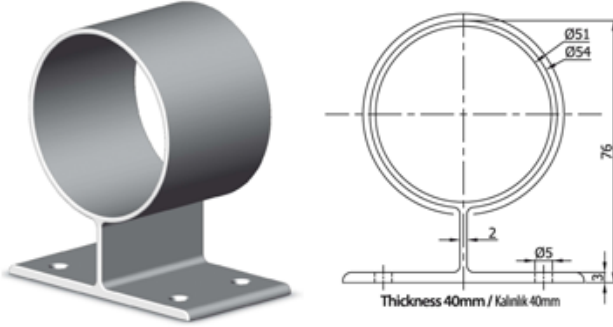

LR41-161

16mm Pipe Plug 16x5mm
16'lik Dolu Tapası

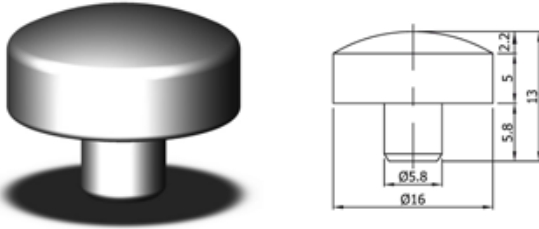

LR41-162

16mm Pipe Plug 16x2mm
16'lik Boru Tapası

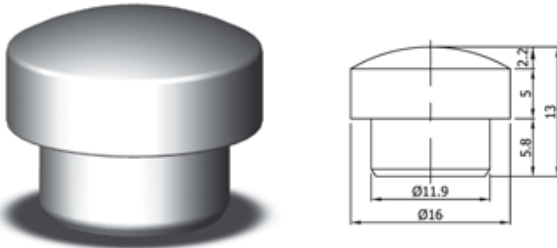

LR41-201

20mm Pipe Plug
20'lik Boru Tapası

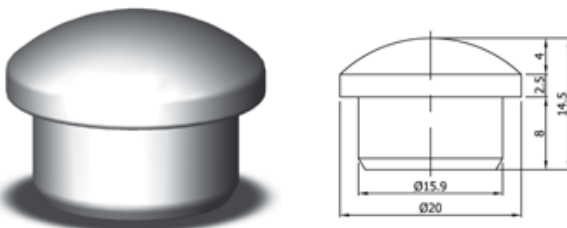

LR41-251

25mm Strut Plug
25'lik Dikme Tapası

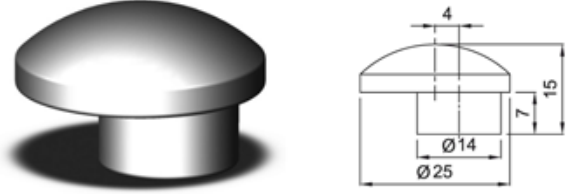

LR41-301

30mm Strut Plug
30'luk Dikme Tapası

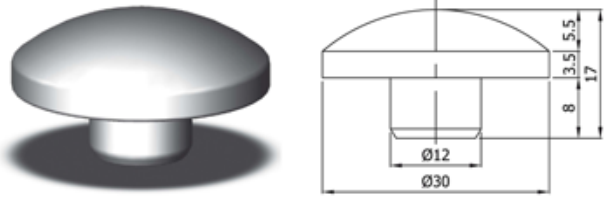

LR41-302

30mm Pipe Plug
30'luk Boru Tapası

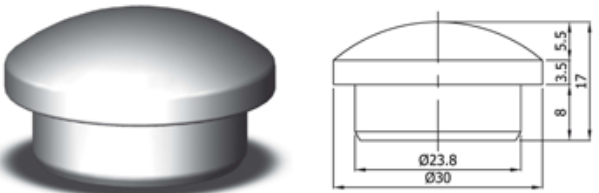

LR41-401

40mm Strut Plug
40'lik Dikme Tapası

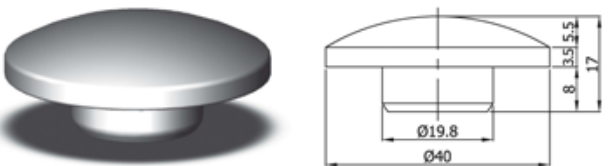

LR41-402

40mm Pipe Plug
40'lik Boru Tapası

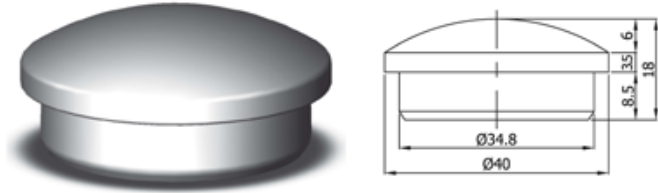

LR41-501

50mm Pipe Plug
50'lik Boru Tapası

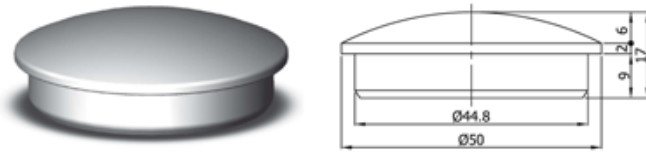

LR41-502

50mm Eco pipe Plug
50'lik Boru Tapası Ekonomik

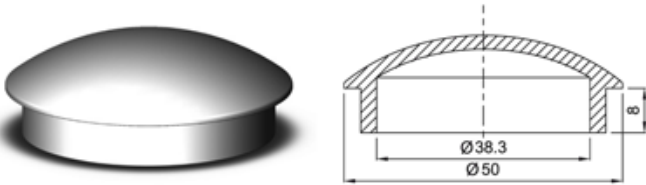

LR41-601

60mm Pipe Plug
60'lik Boru Tapası

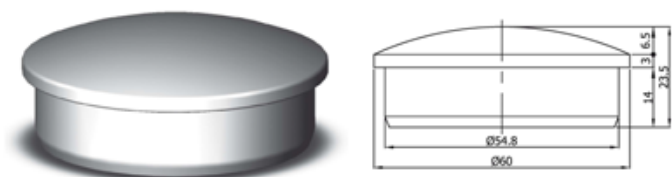

LR41-651

65mm Pipe Plug
65'lik Boru Tapası

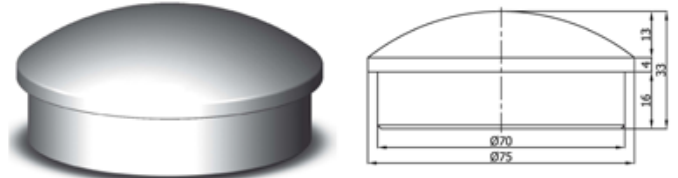

LR42-161

16mm Decorative Plug
16'lik Dekorlu Tapa

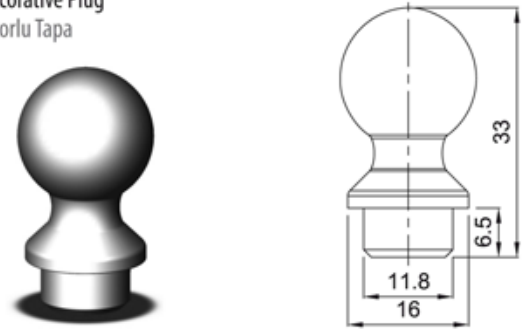

LR42-301

30mm Decorative Plug
30'lik Dekorlu Tapa

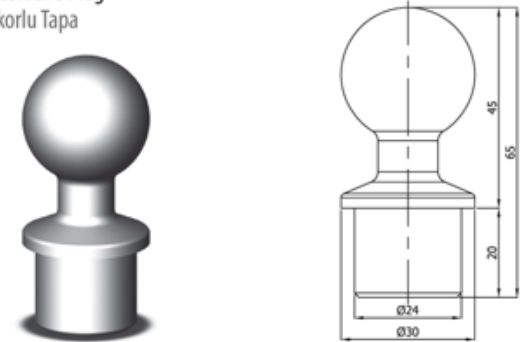

LR42-401

40mm Strut Decorative Plug
40'lik Dikme Dekorlu Tapa

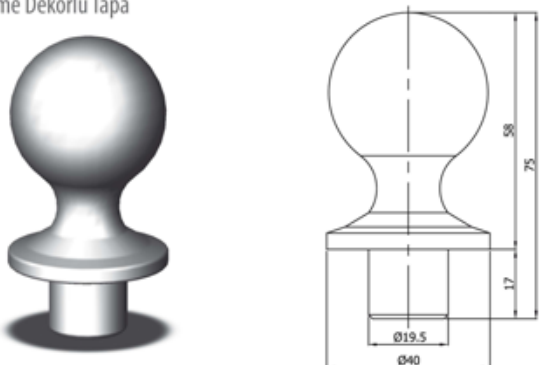

LR42-402

40mm Pipe Decorative Plug
40'lık Boru Dekorlu Tapa

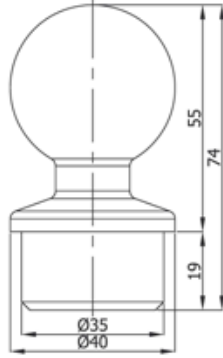

LR42-651

65mm Decorative Plug
65'lik Dekorlu Tapa

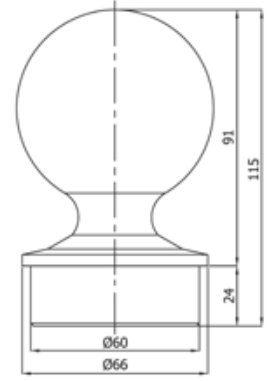

LR42-501

50mm Strut Decorative Plug
50'lik Dikme Dekorlu Tapa

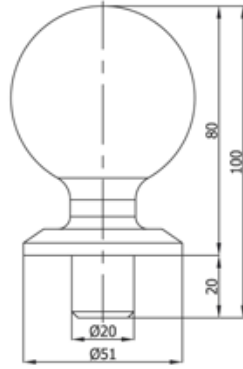

LR43-401

40mm Decorative Crystal Plug
40'lik Dikmeye Göre Dekorlu Kristal Tapa

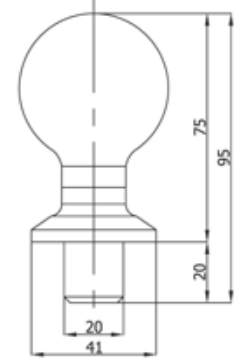

LR42-502

50mm Pipe Decorative Plug
50'lik Boru Dekorlu Tapa

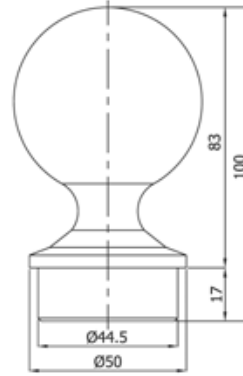

LR43-501

50mm Decorative Crystal Plug
50'lik Boruya Göre Kristal Tapa

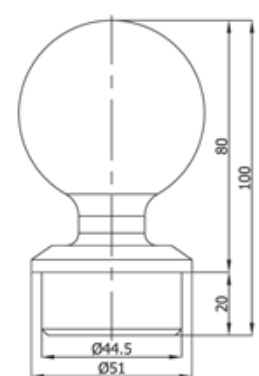

LR42-601

60mm Pipe Decorative Plug
60'lik Boru Dekorlu Tapa

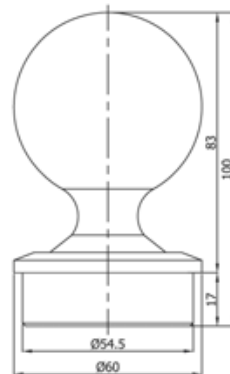

LR43-601

60mm Decorative Crystal Plug
60'lik Boruya Göre Dekorlu Kristal Tapa

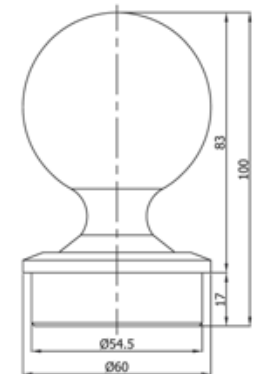

LR43-651

65mm Decorative Crysrtal Plug
65'lik Boruya Göre Dekorlu Kristal Tapa

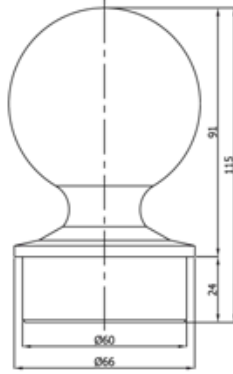

LR44-161

16mm Decorative Plug
16'lik Boruya Göre Dekorlu Tapa

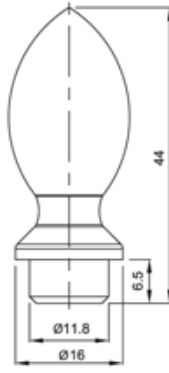

LR44-301

30mm Decorative Plug
30'luk Boruya Göre Dekorlu Tapa

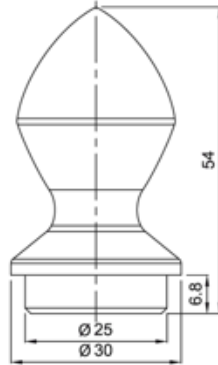

LR51-301

30mm Pipe Glass Holder
30'luk Boru Cam Tutamağı

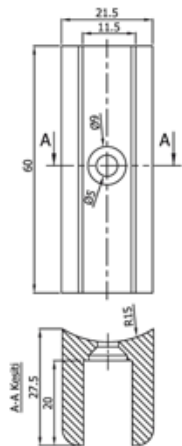
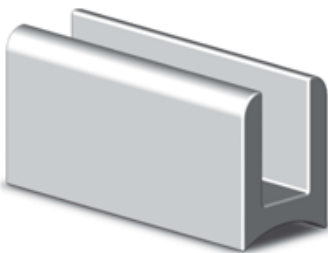

LR51-401

40mm Pipe Glass Holder
40'lik Boru Cam Tutamağı

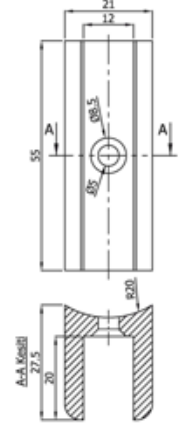
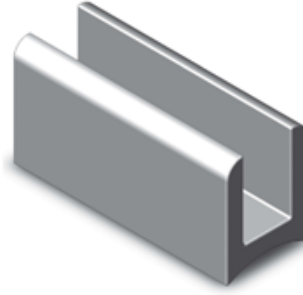

LR51-402

40mm Strut Glass Holder
40'lik Dikme Cam Tutamağı

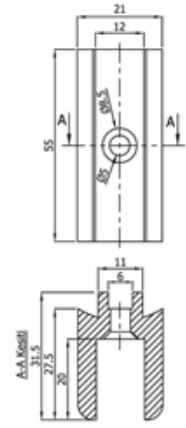
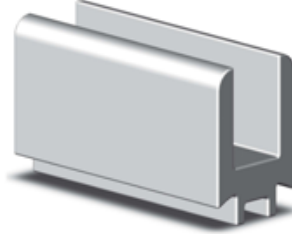

LR51-403

40mm Pipe Screwed Glass Holder
40'lik Boruya Vidalı Cam Tutamağı

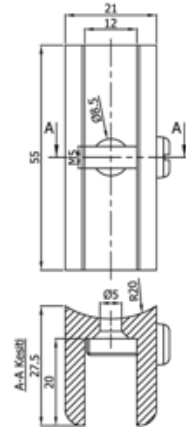
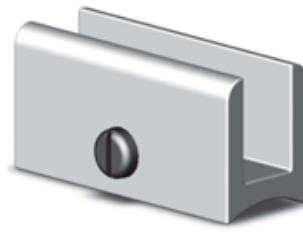

LR51-404

40mm Strut Screwed Glass Holder
40'lik Dikme Vidalı Cam Tutamağı

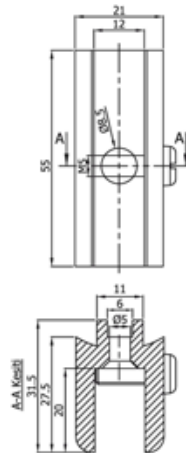
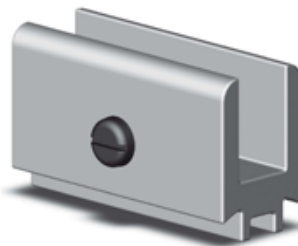

LR51-405

40mm Pipe Sideway Screwed Glass Holder
40'lık Yandan Vidalı Cam Tutamağı

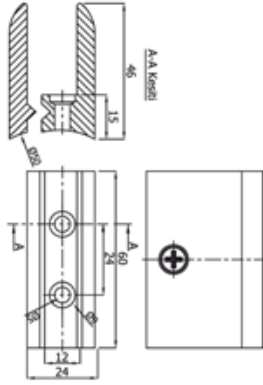

LR51-406

40mm Strut Glass Holder
40'lık Dikme Arası Cam Tutamağı

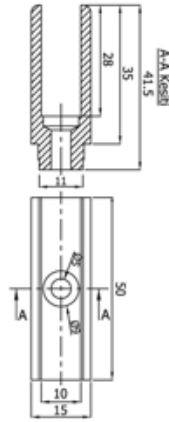

LR51-407

40mm Pipe Adjustable Glass Holder
40'lık Boruya Ayarlı Cam Tutamağı

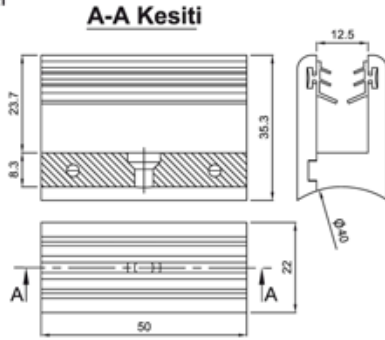

LR51-408

40mm Strut Glass Holder
40'lık Dikmeye Ayarlı Cam Tutamağı

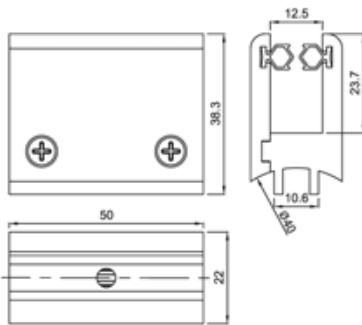

LR52-401

40mm Single Glass Holder
40'lık Tekli Cam Tutamağı

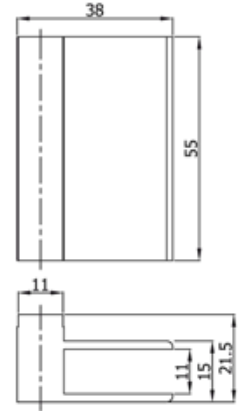

LR52-402

40mm Double Glass Holder
40'lık Çiftli Cam Tutamağı

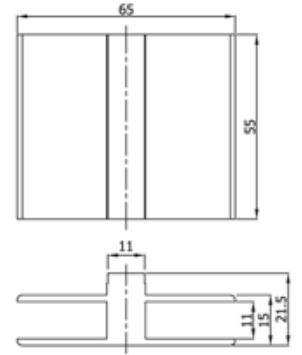
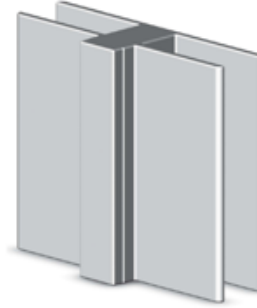

LR52-403

40mm Strut Glass Holder
40'lık Dikme Cam Tutamağı

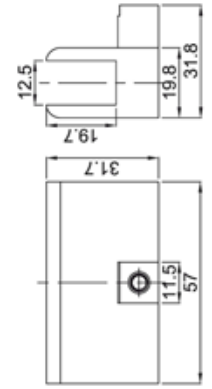
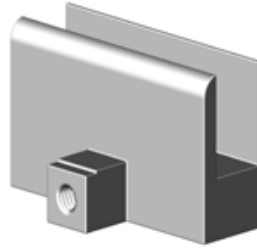

LR53-401

40mm Single Spider Glass Holder
40'lık Tekli Spider Cam Tutamağı

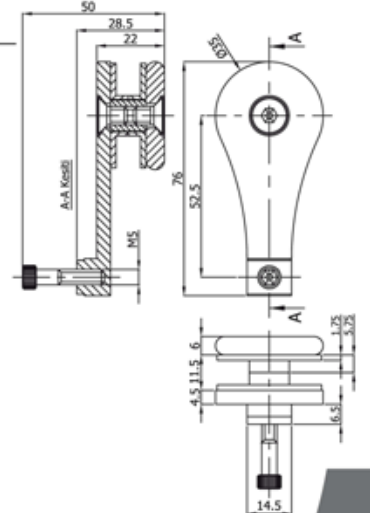

LR53-402

40mm Double Spider Glass Holder
40'luk Çiftli Spider Cam Tutamağı

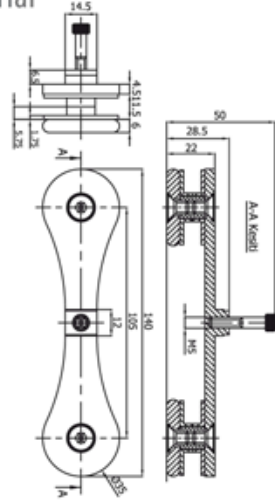

LR53-403

40mm Single Spider Glass Holder
40'luk Tekli Spider Cam Tutamağı

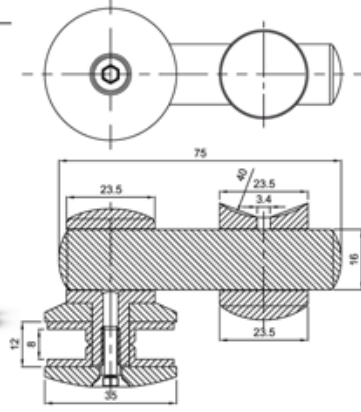

LR53-404

40mm Double Spider Glass Holder
40'luk Çiftli Spider Cam Tutamağı

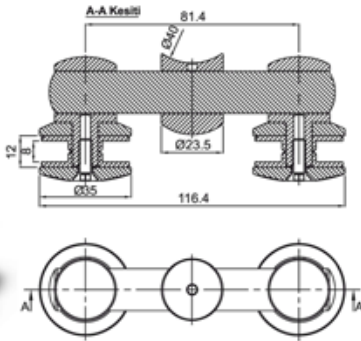

LR54-401

Glass Stopper
Cam Takozu

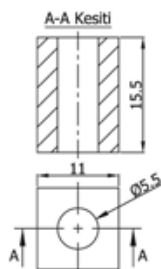

LR61-161

16mm Pipe Holder
16'luk Tutamak Kurt Ağızlı

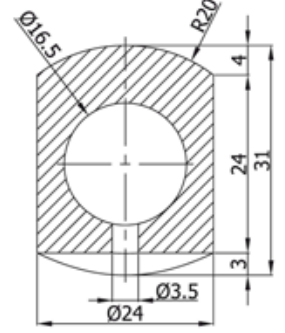

LR61-162

16mm Pipe Holder
16'luk Tutamak

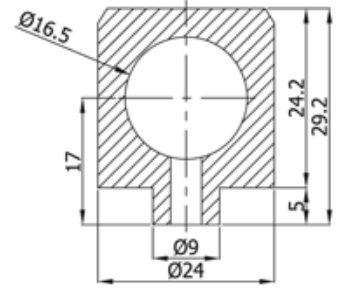

LR61-163

16mm Double Holder
16'luk Tutamak Çiftli

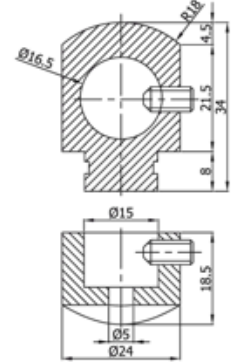

LR61-164

16mm Double Holder (Long)
16'luk Tutamak Çiftli (Uzun)

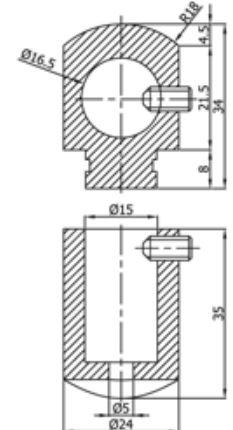

LR61-165

16mm Oval Holder
16'lık Oval Tutamak

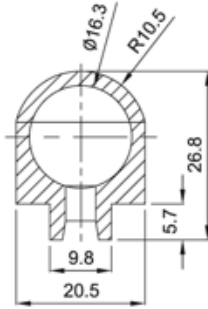

LR64-162

30mm Interconnection For 16mm Pipe (16x30)
16'lık Boruya Göre 30'luk Kurtağzı (16x30)

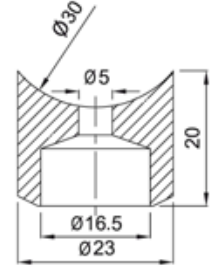

LR62-161

16mm Interconnection
16'lık İç Dış Bağlantı

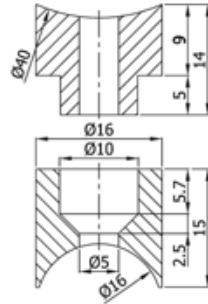

LR64-163

40mm Interconnection for 16mm Pipe (16x40)
16'lık Boruya Göre 40'luk Kurtağzı (16x40)

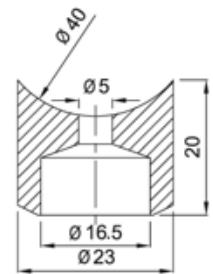

LR63-161

16mm Screwable Plug
16'lık Vida Tapası

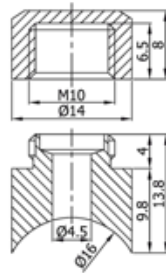

LR64-164

30mm Interconnection For 16mm Pipe (16x30)
16'lık Boruya Göre 30'luk Kurtağzı (16x30)

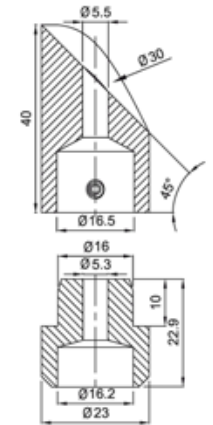

LR64-161

16mm Pipe Interconnection to 30mm Pipe (16x30)
16'lık Dikmeye Göre 30'luk Kurtağzı (16x30)

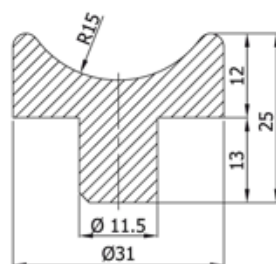

LR64-165

30mm Interconnection For 16mm Pipe (16x30)
16'lık Boruya Göre 30'luk Kurtağzı (16x30)

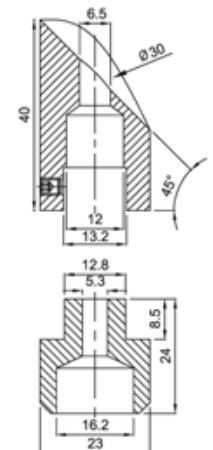
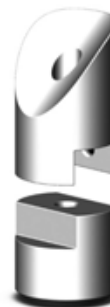

LR64-301

30mm Pipe İnterconnection to 40mm Pipe (30x40)
30'luk Boruya Göre 40'lik Kurtađızı (30x40)

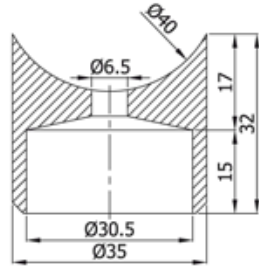

LR64-305

50mm Pipe İnterconnection to 30mm Pipe (30x50)
30'luk Boruya Göre 50'lik Kurtađızı (30x50)

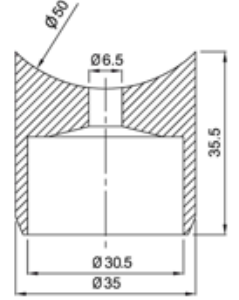

LR64-302

30mm Strut İnterconnection to 40mm Pipe (30x40)
30'luk Dikmeye Göre 40'lik Kurtađızı (30x40)

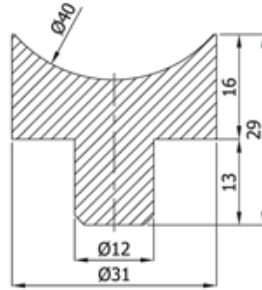

LR64-401

40mm Strut İnterconnection to 40mm Pipe (40x40)
40'luk Dikmeye Göre 40'lik Kurtađızı (40x40)

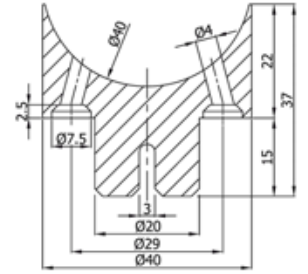

LR64-303

30mm Pipe İnterconnection to 50mm Pipe (30x50)
30'luk Boruya Göre 50'lik Kurtađızı (30x40)

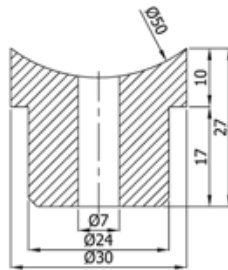

LR64-402

40mm Pipe İnterconnection to 40mm Pipe (40x40)
40'luk Boruya Göre 40'lik Kurtađızı (40x40)

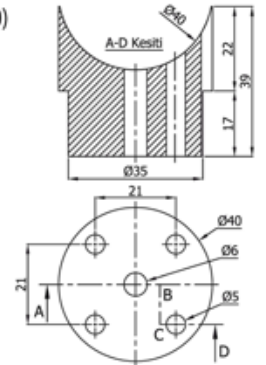

LR64-304

30mm Pipe İnterconnection to 50mm Pipe (30x50)
30'luk Boruya Göre 30'lik Kurtađızı (30x30)

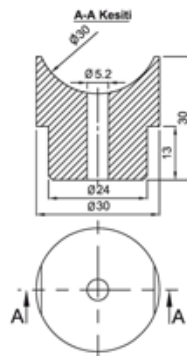

LR64-403

40mm Strut İnterconnection to 50mm Pipe (40x50)
40'luk Dikmeye Göre 50'lik Kurtađızı (40x50)

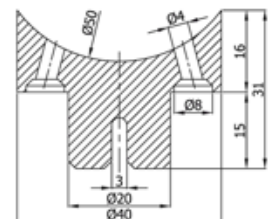

LR64-404

40mm Pipe Interconnection to 50mm Pipe (40x50)
40'lık Boruya Göre 50'lik Kurtağzı (40x50)

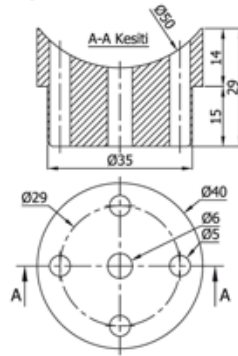

LR64-502

50mm Strut Interconnection to 40mm Pipe (50x40)
50'lik Dikmeye Göre 40'lik Kurtağzı (50x40)

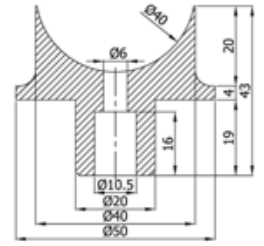

LR64-405

40mm Interconnection For 40mm Pipe (40x40)
40'lık Boruya Göre 40'lik Kurtağzı (40x40)

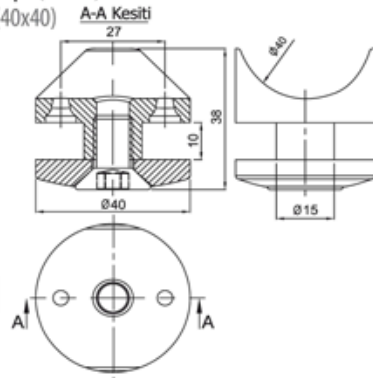

LR64-503

50mm Pipe Interconnection to 50mm Pipe (50x50)
50'lik Boruya Göre 50'lik Kurtağzı (50x50)

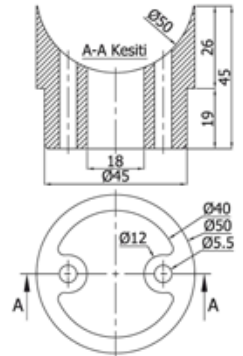

LR64-406

50mm Interconnection For 40mm Strut (40x50)
40'lik Dikmeye Göre 50'lik Ayarlı Kurtağzı (40x50)

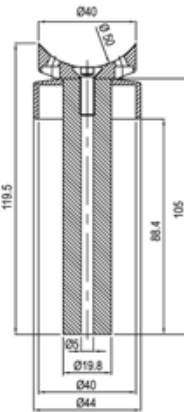

LR65-301

30mm Strut Decorative Interconnection to 50mm Pipe (30x50)
30'lik Dikmeye Göre 50'lik Dekorlu Kurtağzı (30x50)

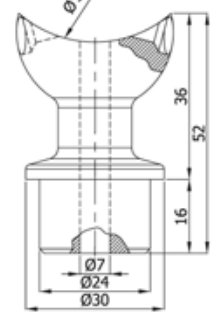

LR64-501

50mm Pipe Interconnection to 40mm Pipe (50x40)
50'lik Boruya Göre 40'lik Kurtağzı (50x40)

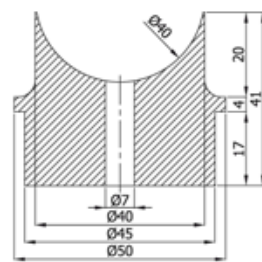

LR65-351

50mm Decorative Interconnection For 35mm Pipe (35x50)
35'lik Sistem 35'lik Boruya Göre 50'lik Dekorlu Kurtağzı (35x50)

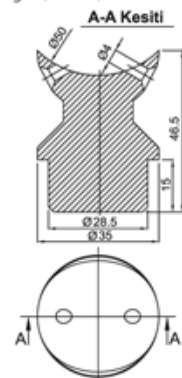

LR65-401

40mm Strut Decorative İnterconnection to 50mm Pipe (40x50)
40'lık Dikmeye Göre 50'lik Dekorlu Kurtağzı (40x50)

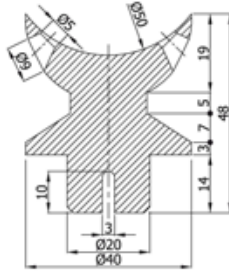

LR65-402

40mm Strut Decorative İnterconnection long to 50mm Pipe (40x50)
40'lık Dikmeye Göre 50'lik Dekorlu Kurtağzı Uzun (40x50)

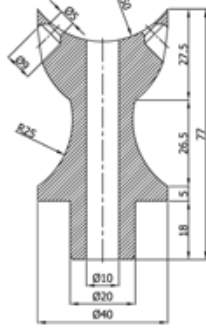

LR66-501

50mm Pipe Decorative Plug Connection
50'lik Dekorlu Tapa Bağlantısı

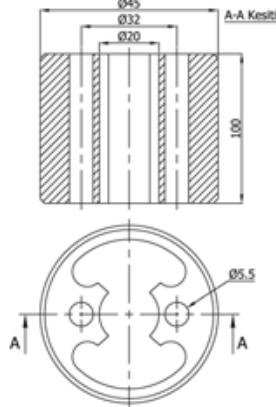

LR66-601

60mm Pipe Decorative Plug Connection
60'lik Dekorlu Tapa Bağlantısı

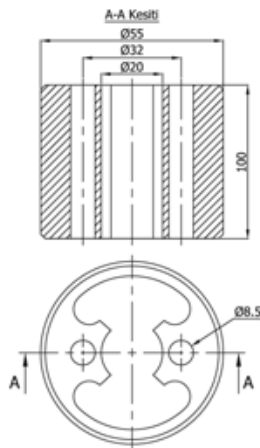

LR66-651

65mm Pipe Decorative Plug Connection
65'lik Dekorlu Tapa Bağlantısı

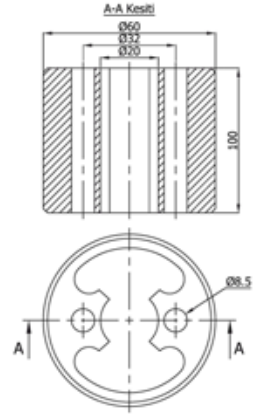

LR67-501

50mm Pipe Wall Bottom Set
50'lik Duvar Dibi Takım

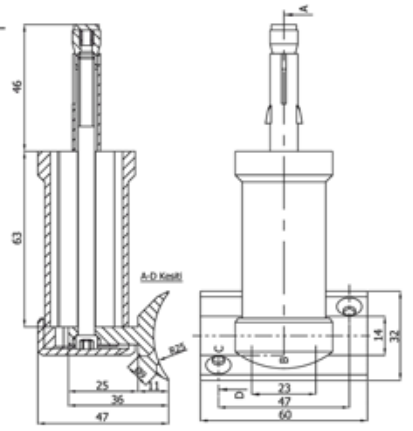

LR67-502

50mm Pipe Wall Bottom Set
50'lik Boruya Göre Duvar Dibi Takım

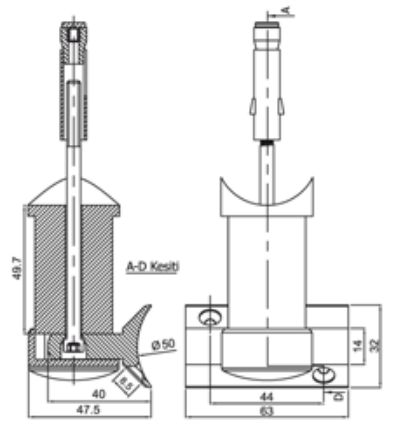

LR68-301

30mm Strut Wall Interconnection 30x40
30'luk Dikmeye Duvar Ara Bağlantı 30x40

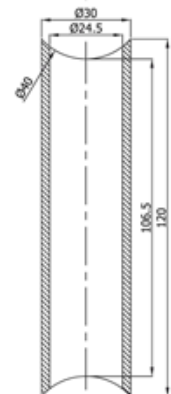
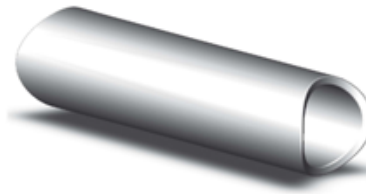

LR68-401

40mm Strut Wall Interconnection
40'lık Dikmeye Duvar Ara Bağlantı

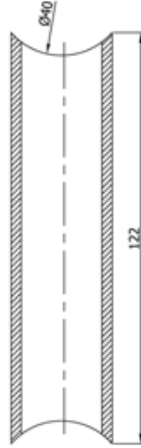

LR68-402

40mm Strut Sideway Special Interconnection
40'lık Dikme Yandan Özel Ara Bağlantı

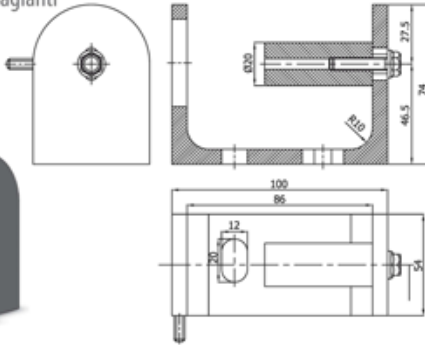

LR68-501

50mm Strut Wall Interconnection
50'lık Dikmeye Duvar Ara Bağlantı

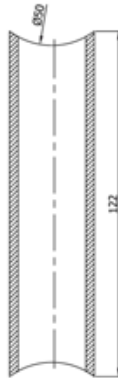

LR69-301

30mm Lateral Interconnection
30'luk Yandan Ara Bağlantı

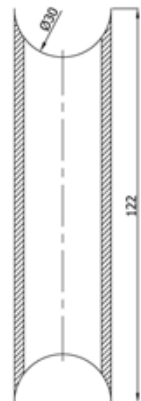

LR69-401

40mm Lateral Interconnection
40'lık Yandan Ara Bağlantı

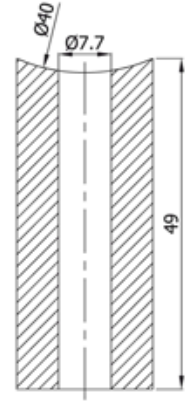

LR69-501

50mm Lateral Interconnection
50'lık Yandan Ara Bağlantı

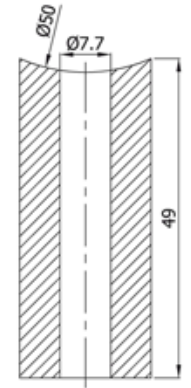

LR69-502

Wall Washer
Duvar Pulu

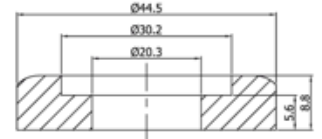
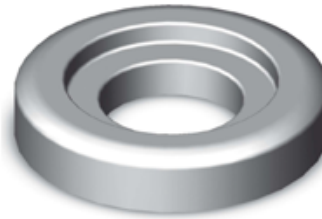

LR69-251

25mm Dual Hanger
25'lik Çifli Askı

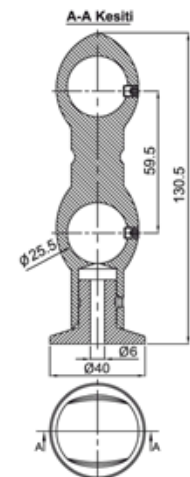

LR69-351

30mm Single Hanger
30'luk Tekli Askı

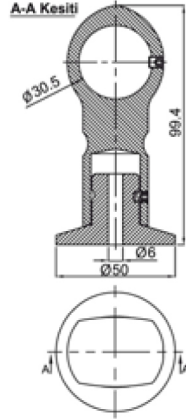
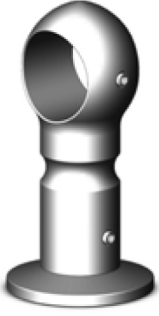

LR71-161

16mm Pipe 90° Tube Bend
16'luk Dirsek 90°

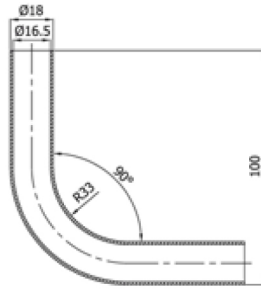

LR71-162

16mm Pipe 135° Tube Bend
16'luk Dirsek 135°

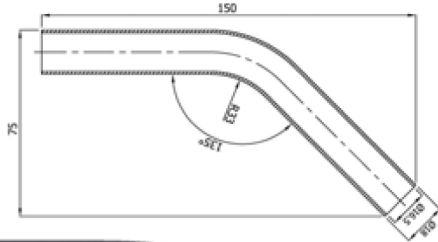

LR71-163

16mm Elbow 30°
16'luk Dirsek 30°

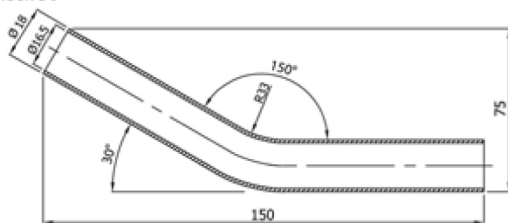

LR71-164

16mm Decorative Security Profile
16'luk Dekorlu Emniyet Profili

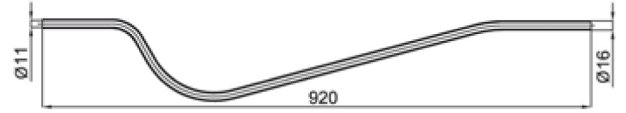
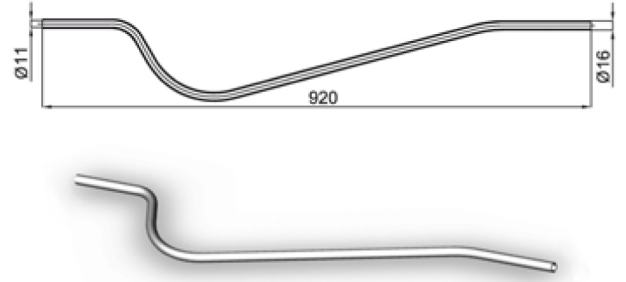

LR71-501

50mm Elbow 90°
50'luk Dirsek 90°

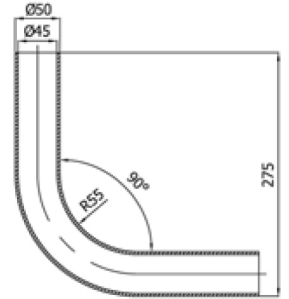

LR72-161

16mm Sphere Bend
16'luk Küre Dirsek

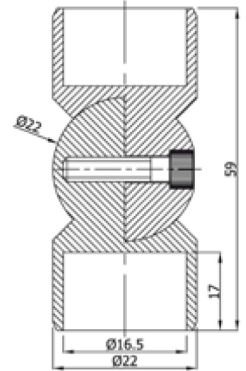

LR72-162

16mm Ball Corner Joint For 40mm Pipe
16'luk Küre 40'luk Boruya Göre Bağlantı

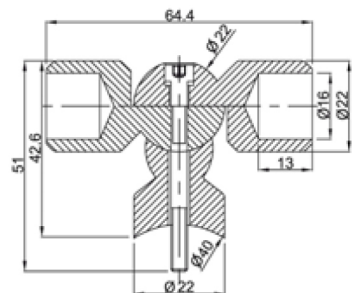
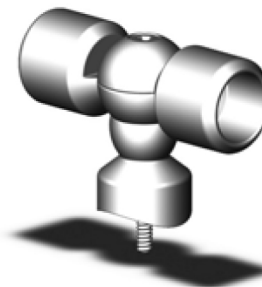

LR72-301

30mm Sphere Bend
30'luk Küre Dirsek

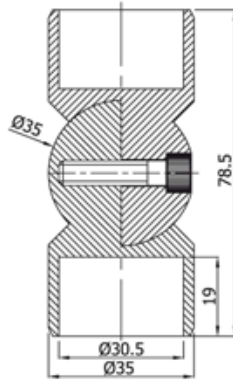

LR72-503

Adjustable Wall Flange For 50mm Pipe
50'lik Fransız Balkon Küre

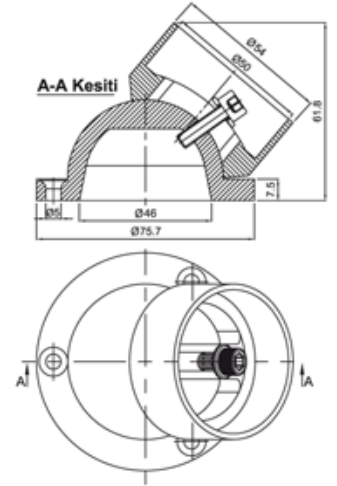

LR72-401

40mm ball corner joint
40'lik Bilezikli Küre Dirsek

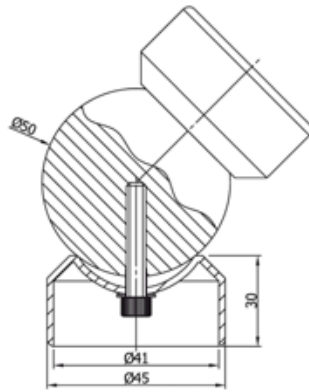

LR72-601

60mm Sphere Bend
60'lik Küre Dirsek

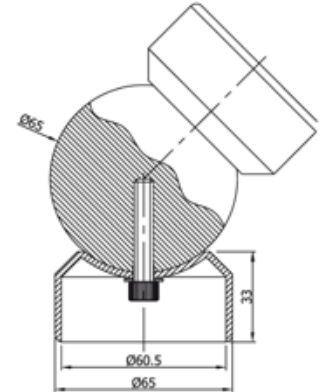

LR72-501

50mm Sphere Bend With Joint
50'lik Bilezikli Küre Dirsek

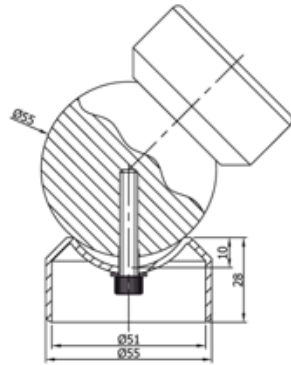

LR73-301

30mm 1/8 Bend With Connection
30'luk 1/8 Simit Bağlı

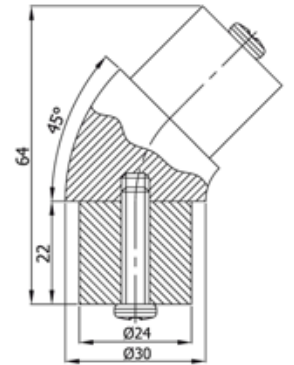

LR72-502

50mm Sphere Bend With Joint
50'lik Mafsallı Küre Dirsek

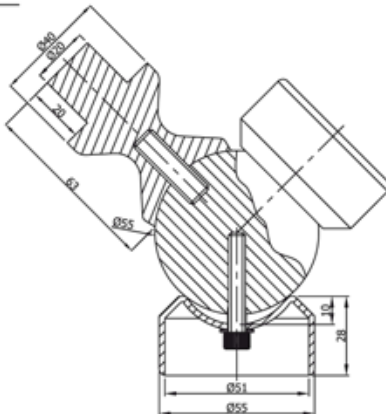

LR73-401

40mm 1/4 Bend With Connection
40'luk 1/4 Simit Bağlı

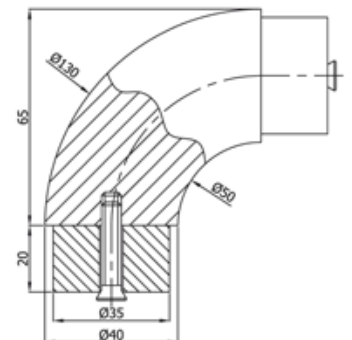

LR73-402

40mm 1/8 Bend With Connection
40'lık 1/8 Simit Bağlı

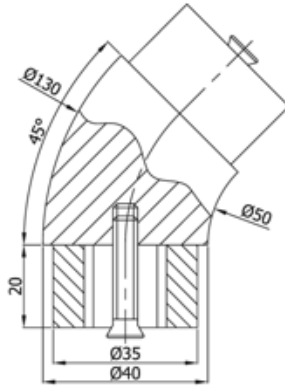

LR73-602

60mm 1/8 Bend
60'lık 1/8 Simit Bağlı

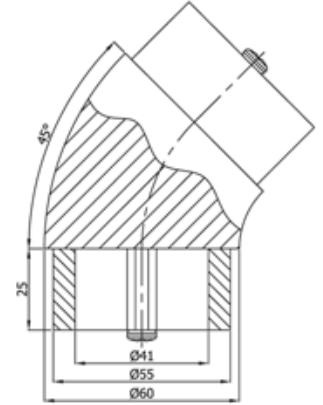

LR73-501

50mm 1/4 Bend With Connection
50'lık 1/4 Simit Bağlı

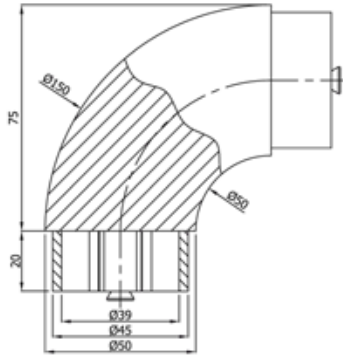

LR74-501

50mm 1/8 Empty Bend
50'lık 1/8 Simit Boş Takozlu

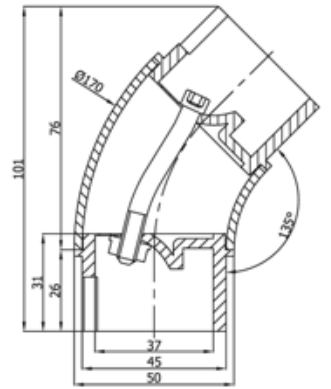

LR73-502

50mm 1/8 Bend
50'lık 1/8 Simit Bağlı

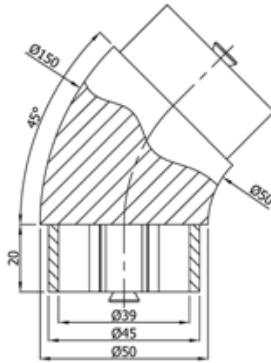

LR74-502

50mm 1/4 Empty Bend
50'lık 1/4 Simit Boş Takozlu

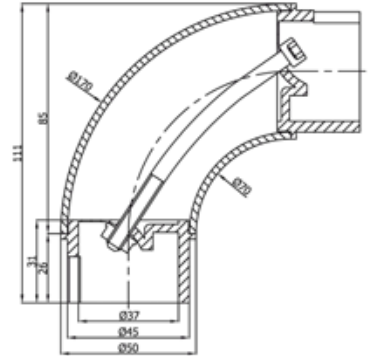

LR73-601

60mm 1/4 Bend
60'lık 1/4 Simit Bağlı

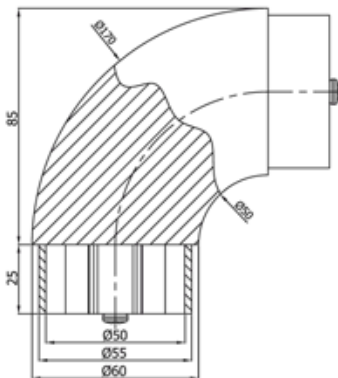

LR74-503

50mm 1/8 Empty Bend
50'lık 1/8 Simit Boş Bilezikli

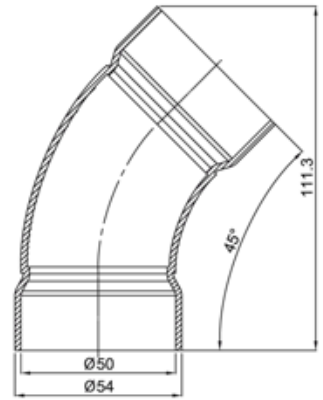

LR74-504

50mm 1/4 Empty Bend
50'lik 1/4 Simit Boş Bilezikli

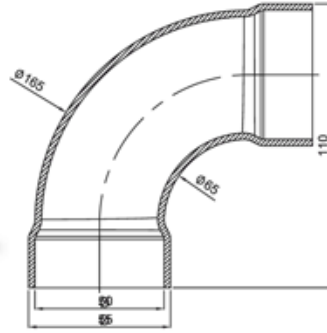

LR81-301

30mm Strut Anchor 21cm
30'luk Ankrāj Demiri 21cm

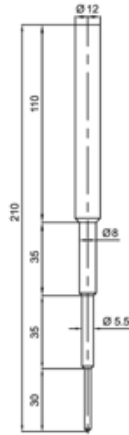

LR81-401

40mm strut Anchor 14cm
40'lik Ankrāj Demiri 14 cm

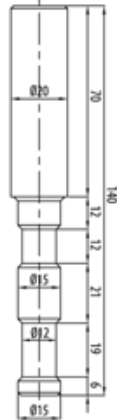

LR81-402

40mm Strut Anchor 24cm
40'lik Ankrāj Demiri – 24 cm



LR81-403

40mm Strut Anchor 22cm
40'lik Ankrāj Demiri 22 cm

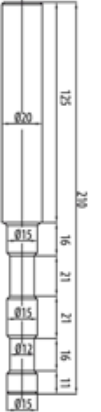

LR81-404

40mm Strut Screwable Anchor
40'lik Vidalı Ankrāj Demiri

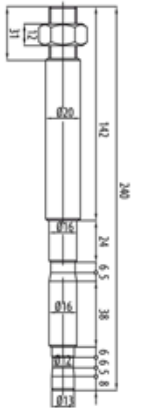

LR81-405

Anchor From Side
Yandan Ankrāj Demiri

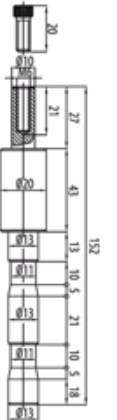
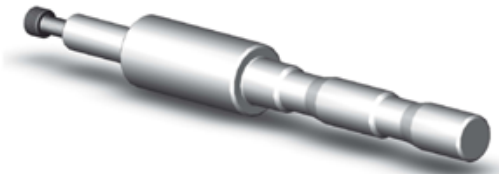

LR81-406

40mm Strut Anchor 48cm
40'lik Ankrāj Demiri 48cm

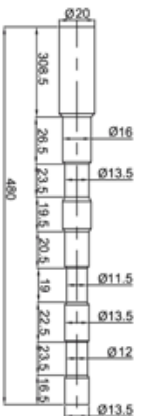

LR84-101

Epoxy
Epoksi



LR84-102

Epoxy gun
Epoksi Tabancası



LR84-103

Selfix Marble Adhesive
Selfix Mermer Yapıştırıcısı



accessories

Square & Rectangular Handrails
Kare ve Dikdörtgen Küpeřteler

gürsanpatentlidir / gürsanpatented

aksesuarlar

flatbarposts / lamadikmeler

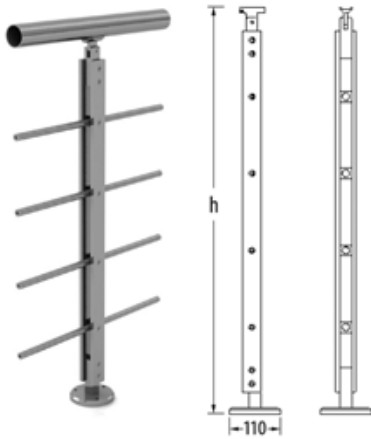

Code / Kod	h (mm)	# Paralel
LLA 853	850	3
LLA 854	850	4
LLA 954	950	4
LLA 955	950	5

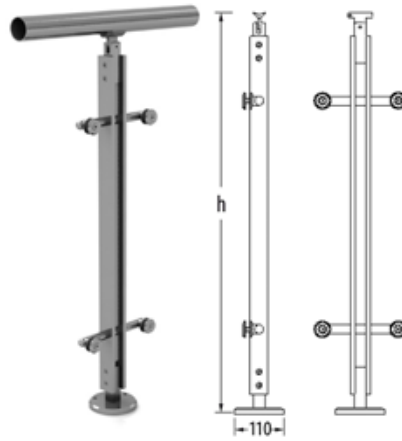

Code / Kod	h (mm)
LLA 85 CD	850
LLA 95 CD	950



Code / Kod	h (mm)
LLA 85 CS	850
LLA 95 CS	950

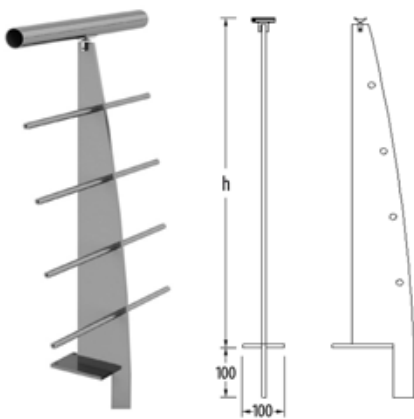

Code / Kod	h (mm)	# Paralel
LLC 853	850	3
LLC 854	850	4
LLC 954	950	4
LLC 955	950	5

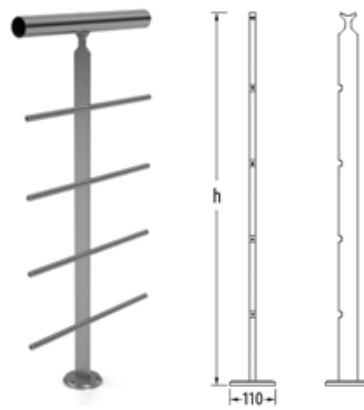

Code / Kod	h (mm)	# Paralel
LLB 853	850	3
LLB 854	850	4
LLB 954	950	4
LLB 955	950	5



infillpanels / cumbalar

Code / Kod	h (mm)	a (mm)
LP 121 C	70	12
LP 141 C	70	14
LP 141 CL	80	14

LF 311 \square 30x25

Regular Flang For Rectangular Rail Profile
30mm Dikdörtgen Ray Profil Flaşı

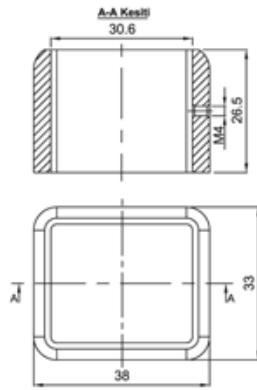

LF 522 \square 50x25

Regtangle Strut Flange Long
Dikdörtgen Dikme Flaşı Uzun

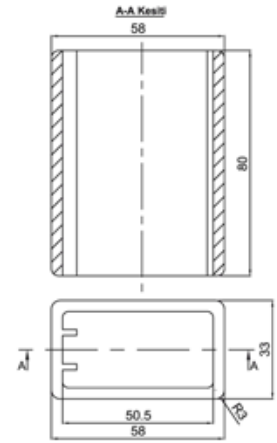

LF 421 \square 40

Regular Flange For Square Post
Kare Dikme Flaşı

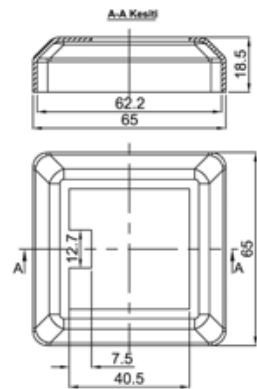

LF 611 \square 60x25

Flange For Rectangular Handrail
Dikdörtgen Küpeşte Flaşı

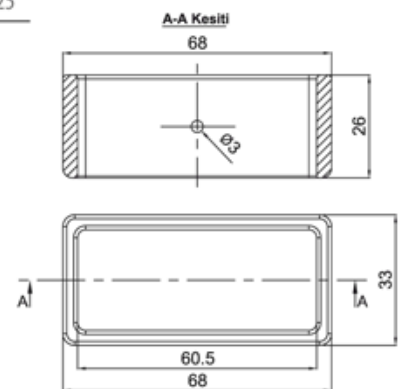

LF 422 \square 40

Square Strut Flange Long
Kare Dikme Flaşı Uzun

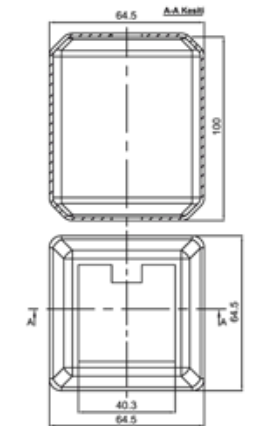

LF 611A \square 60x25

Regtangle Balustrade Flange
Dikdörtgen Küpeşte Flaşı

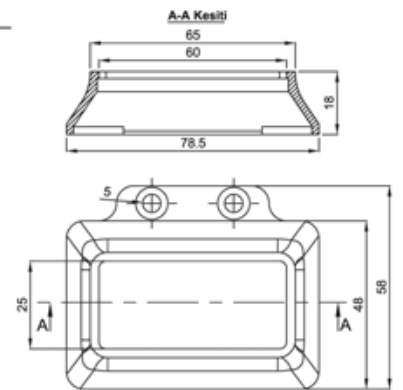

LF 521 \square 50x25

Flange For Rectangular Post
Dikdörtgen Dikme Flaşı

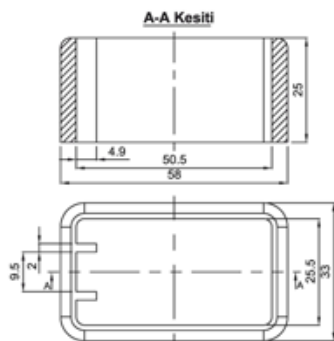

LF 751 \square 75

Flange For Square Column
Kare Baba Flaşı

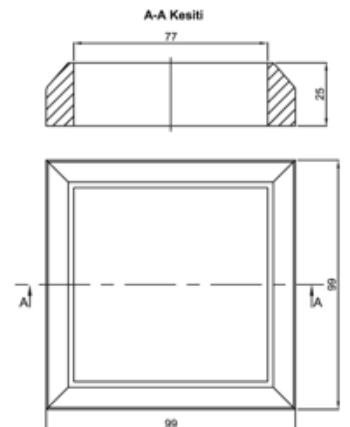

LF 801

80x30

Wall Flange For Rectangular Handrail
Dikdörtgen Küpeşte Duvar Flanşı

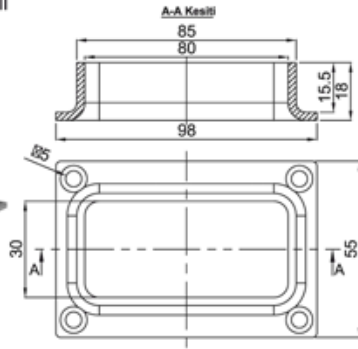

LF 801A

80x30

Rectangle Balustrade Wall Flange
Dikdörtgen Küpeşte Duvar Flanşı

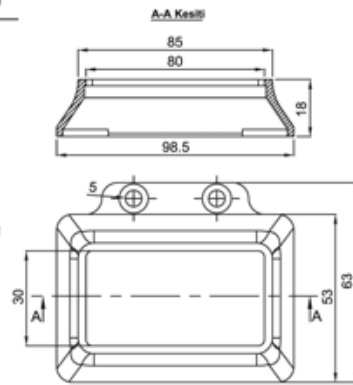

LM 102A

Rail Wall L Joint
Duvar Küpeşesi L Mafsalı

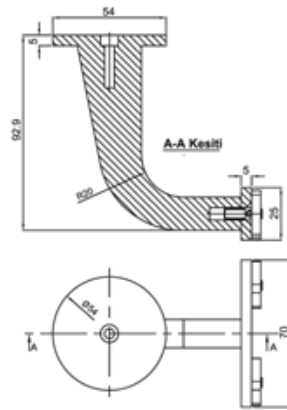

18-127-018
18-119-020
18-120-020

LM 411B

Rectangular Post Joint
4020 Seri Dikdörtgen Küpeşte Mafsalı

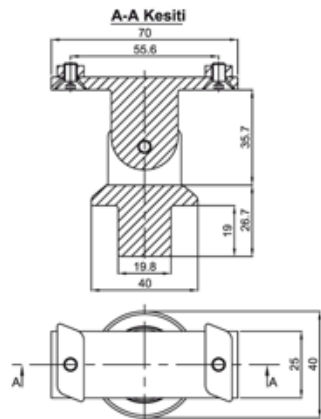

18-127-018
18-119-020
18-120-020

LM 417

4020 Serie Bracket For Rectangular Handrail
4020 Seri Dikdörtgen Küpeşte Mafsalı



18-127-018
18-119-020
18-120-020

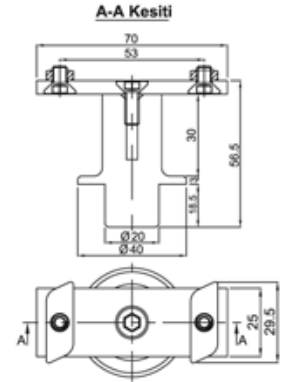

LM 417A

Rectangular Corner Post Joint
4020 Seri Dikdörtgen Köşe Küpeşte Mafsalı



18-127-018
18-119-020
18-120-020

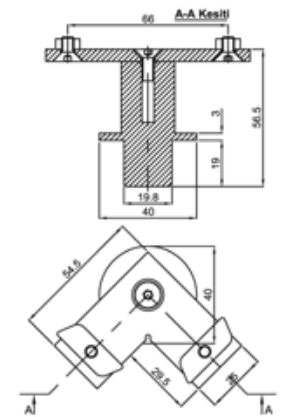

LM 417B

Rectangular Corner Post Joint
4020 Seri Dikdörtgen Köşe Küpeşte Mafsalı



18-127-018
18-119-020
18-120-020

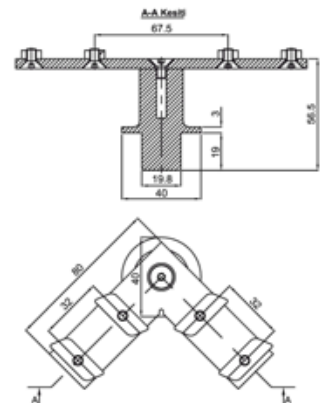

LM 418

80x30

4020 Serie Corner Bracket For Rectangular Handrail
4020 Seri Dikdörtgen Küpeşte Köşe Mafsalı

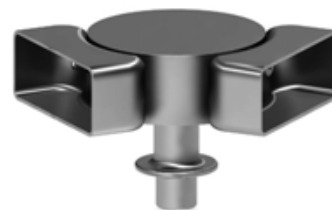

18-119-020
18-120-020

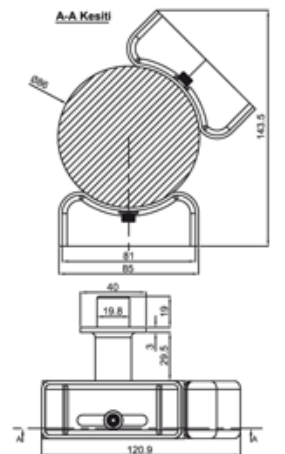

LM 419

60x25

4020 Series Corner Bracket For Rectangular Handrail
4020 Seri Dikdörtgen Küpeşte Köşe Mafsalı

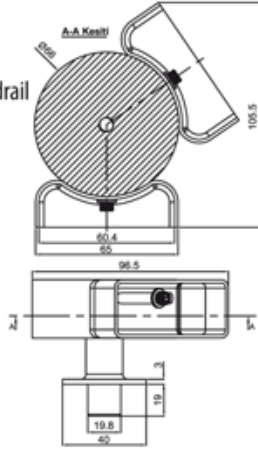

18-127-018
18-128-018

LM 421

Ø 50-60

Regular Bracket For 40 mm Square Post
Kare Dikme Üstten Mafsalı

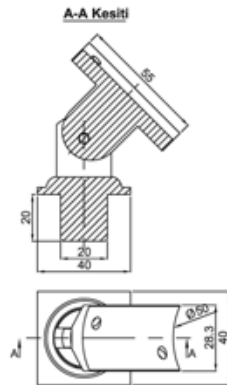

LM 421B

Square Corner Post Joint
Kare Dikme Dikdörtgen Küpeşte Mafsalı

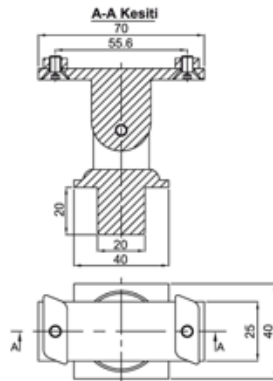

18-127-018
18-119-020
18-120-020

LM 422A

Rectangular L Joint
Dikdörtgen Küpeşte

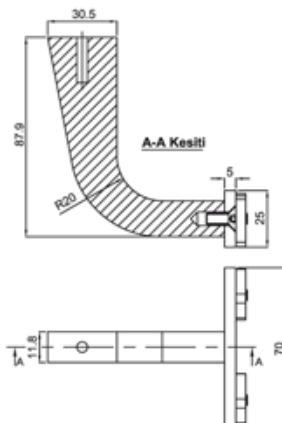

18-127-018
18-119-020
18-120-020

LM 425

Ø 50

Stable Bracket For 40 mm Square Post
Kare Dikme Sabit Mafsalı



18-128-018

LM 425A

Ø 50-60

Square Post Joint From Top
Kare Dikme Üstten Mafsalı

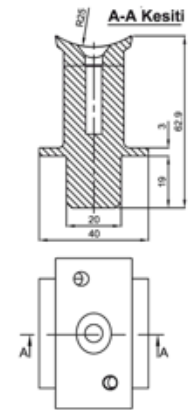

18-128-018

LM 426

Ø 50

Corner Bracket For 40 mm Square Post
Kare Dikme Köşe Mafsalı

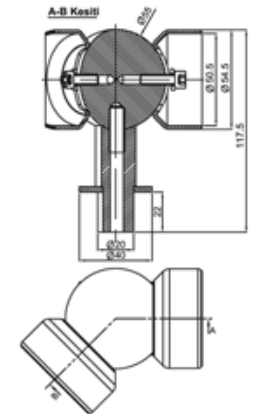

LM 427

40 mm Square Bracket For Rectangular Handrail
Kare Dikme Dikdörtgen Küpeşte Mafsalı

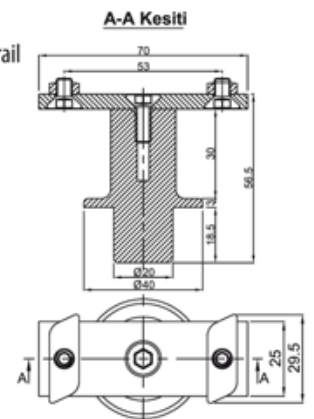

18-127-018
18-119-020
18-120-020

LM 527

50x25

Rectangular Handrail Bracket For Rectangular Post
Dikdörtgen Dikme Dikdörtgen Kúpeşte Mafsalı



18-127-018
18-119-020
18-120-020

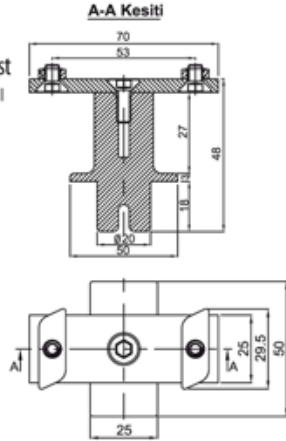

LB 801

80x30

Ring For Rectangular Handrail
Dikdörtgen Kúpeşte Bileziđi

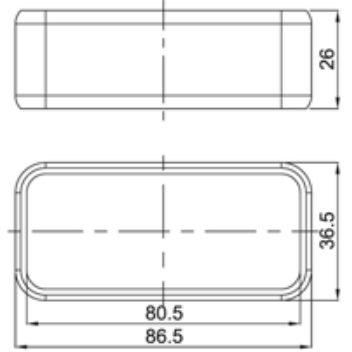

LB 141

14

Ring For 14x14 Square Profile
14x14 Kare Profil Bileziđi

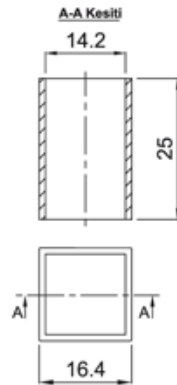
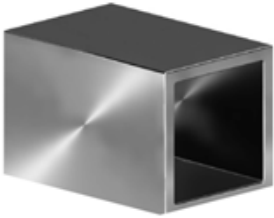

LT 141

14

Cap For 14x14 Square Profile
14x14 Kare Profil Tapası

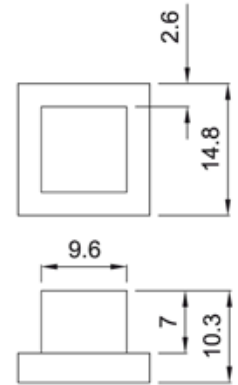

12-153-020R

LB 311

30x25

Ring For 30mm Rectangular Rail Profile
30mm Dikdörtgen Ray Profil Bileziđi

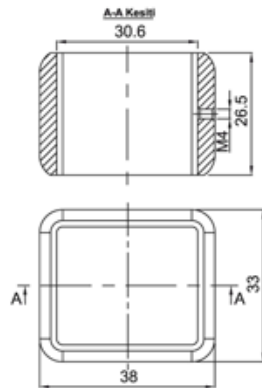

LT 311

Cap For 30mm Rectangular Rail Profile
30mm Dikdörtgen Ray Profili Tapası

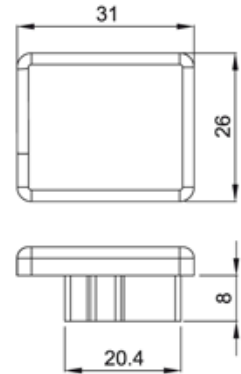
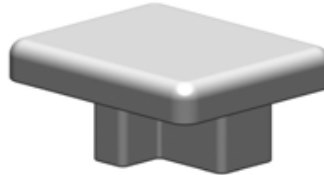

18-122-00

LB 611

60x25

Ring For Rectangular Handrail
Dikdörtgen Kúpeşte Bileziđi

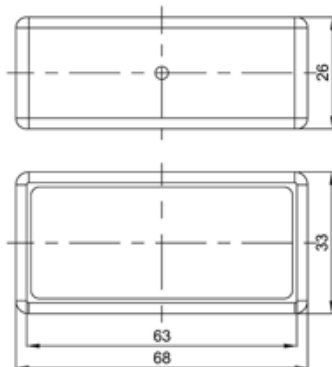

LT 421

Cap For 40mm Square Post
Kare Dikme Tapası

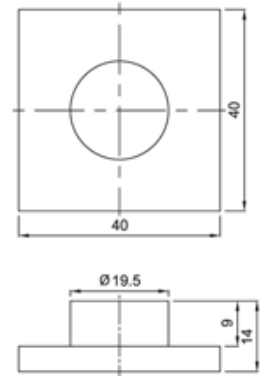
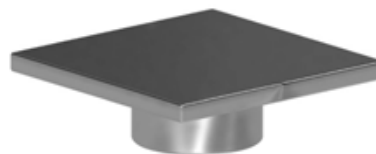

18-115-015
18-116-015

LT 611

60x25

Cap For Rectangular Hanrail Profile
Dikdörtgen Küpeşte Tapası

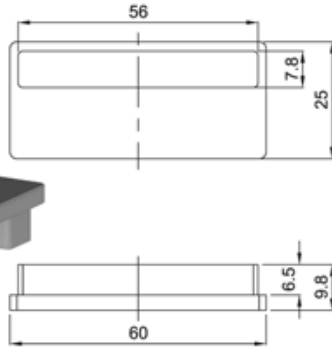
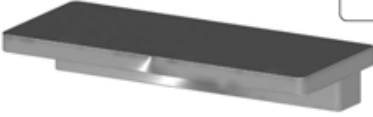

18-127-018
18-128-018

LT 751

75

Cap For Square Column
Kare Baba Tapası

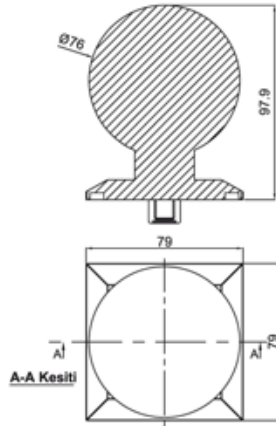
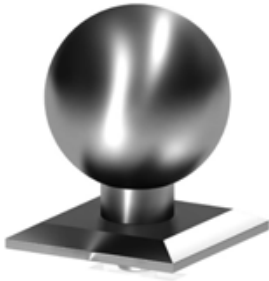

18-125-016

LT 801

80x30

Cap For Rectangular Handrail
Dikdörtgen Küpeşte Tapası

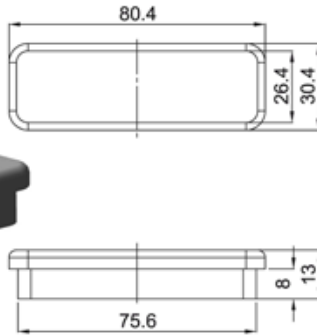
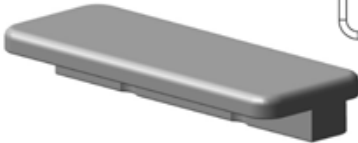

18-119-020
18-120-020

LT 306

18-306-00 Profile Side Cap
18-306-00 Profil Yan Tapası

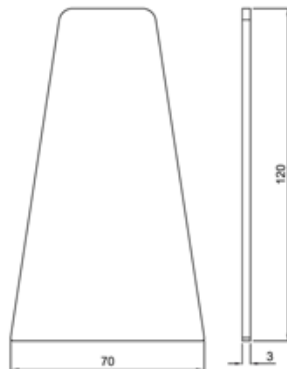
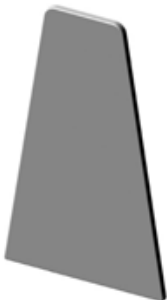

LC 521

Glass Holder For Rectangular Post
Dikdörtgen Dikme Cam Tutucusu

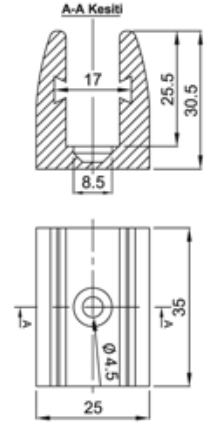
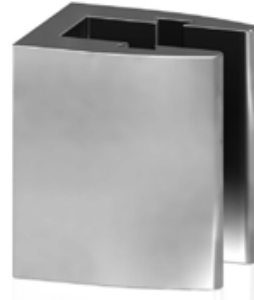

LC 421

Regular Glass Holder For 40mm Square Post
Kare Dikmeye Göre Cam Tutucusu

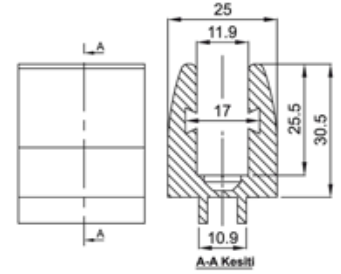

LY 103

12

Diagonal Center Holder
Kare Çapraz Motif Göbeği

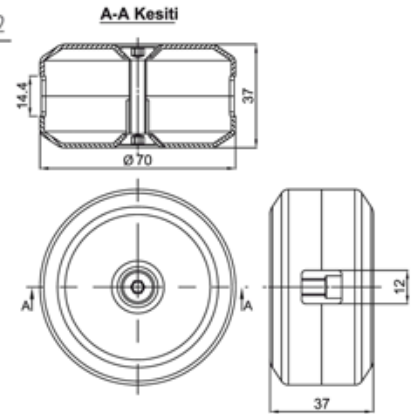

12-141-020R

LY 311

Adaptor For 30mm Rectangular Rail Profile (Right)
30mm Dikdörtgen Ray Profili Bağlantı Adaptörü (Sağ)

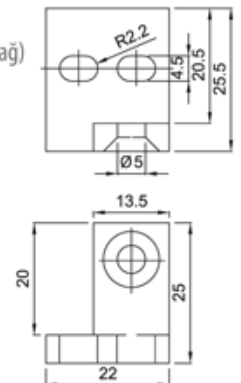

18-122-00

LY 311A

30mm Rectangle Rail Profile Joint Element (Left)
30mm Dikdörtgen Ray Profili Bağlantı Adaptörü (Sol)

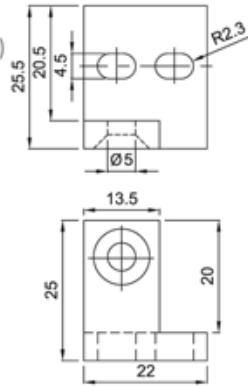
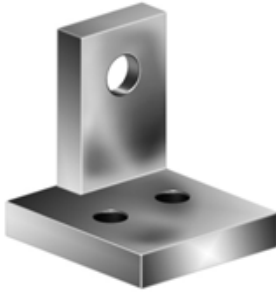

18-122-00

LY 402A

Square Adapter For Round Part Of
40mm Dikme Kare Adaptörü Boruya Göre

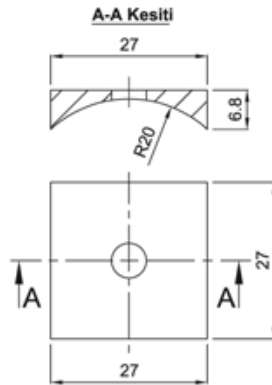
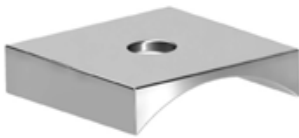

LY 428

40

Side Installation Bracket For Square Post
Kare Dikme Yan Bağlantı Pabucu

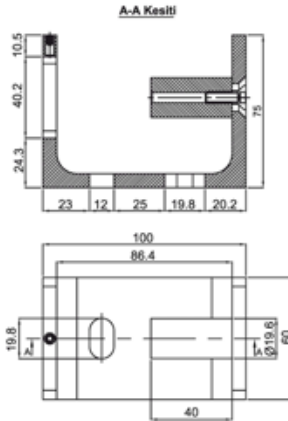

LY 428A

40

Side Installation Bracket For Square Post (Long)
Kare Dikme Yan Bağlantı Pabucu (Uzun)

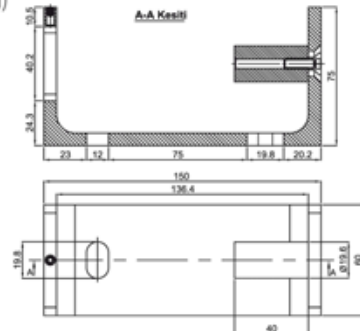

LY 521

50x25

Side Installation Bracket For Rectangular Post
Dikdörtgen Dikme Yan Bağlantı Pabucu

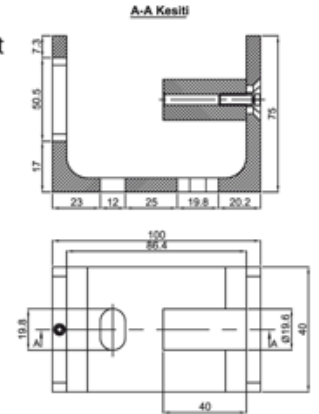

LY 521A

50x25

Side Installation Bracket For Rectangle Post (Long)
Dikdörtgen Dikme Yan Bağlantı Pabucu (Uzun)

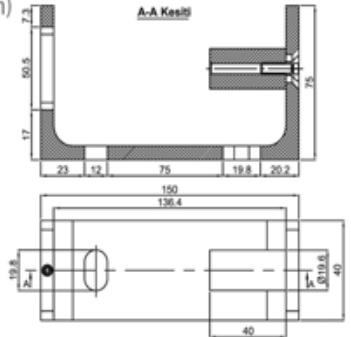

LY 611

60x25

Wall Adapter For Rectangular Handrail
Dikdörtgen Küşpeşte Bağlantı Adaptörü

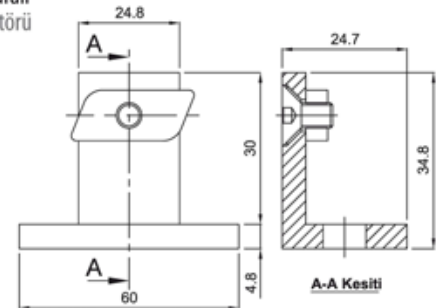

18-127-018
18-119-020

LS 141

14

90° Elbow For
Kare 90° Dönüş

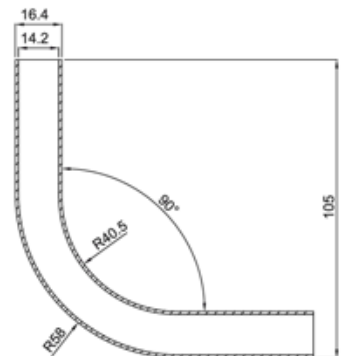

LS 142

14

45° Elbow For
Kare 45° Dönüş

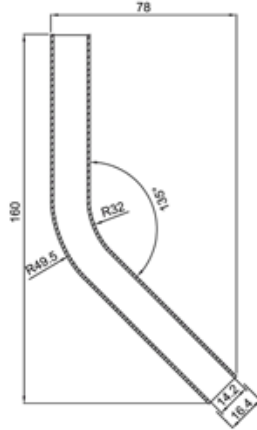

LS 142A

14

30° Elbow For
Kare 30° Dönüş

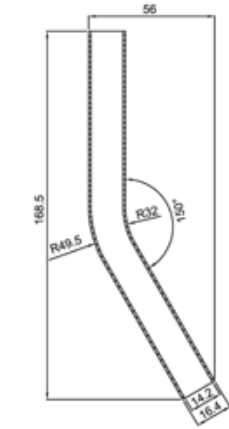

LS 143

14

Adjustable Elbow For
Küre Dönüş Küresi 0-90°

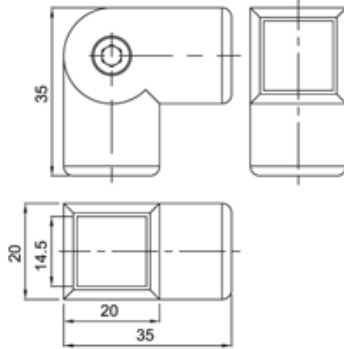
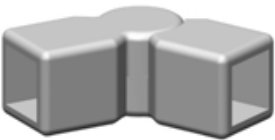

LS 311

30x25

30x25 Rectangle 90° Bend
30x25 Dikdörtgen 90° Dönüş

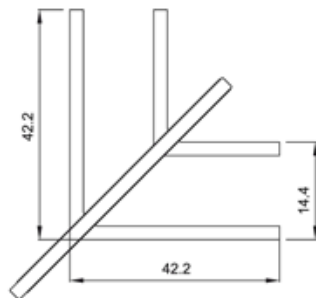
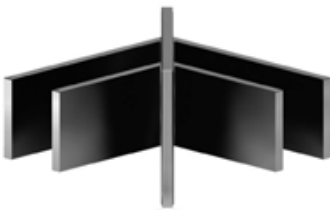

LS 314

30x25

30x25 Rectangle 90° Corner Joint
30x25 Dikdörtgen Dönüş Küresi

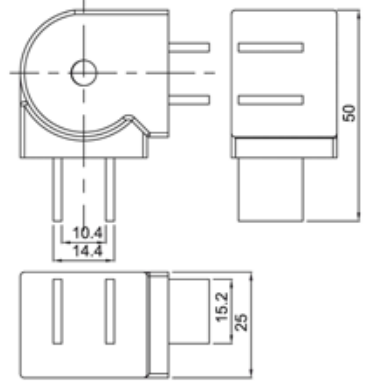
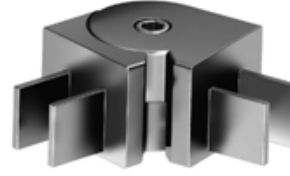

LS 506

0-90° Adjustable Elbow
Cam Kanallı Ayarlanabilir Dirsek 0-90°

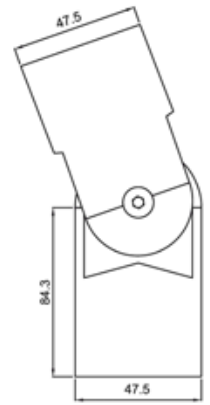

18-302-025

LS 611B

60x25

90° Corner Joint Plate
90° Köşe Birleşim Sacı

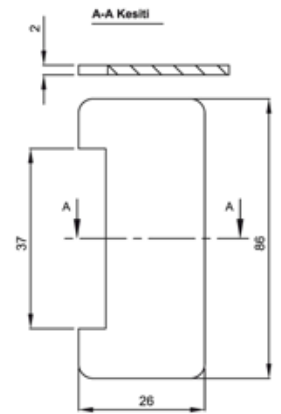

18-127-018

LS 612B

60x25

45° Corner Joint Plate
45° Köşe Birleşim Sacı

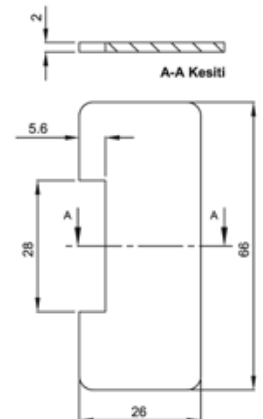
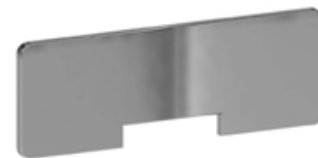

18-127-018

LS 614

60x25

Rectangle Rail Adjustable Corner 0-90°
Dikdörtgen Kúpeşte Ayarlı Dönüş Küresi 0-90°

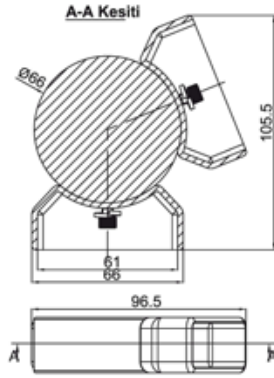

LS 614A

60x25

Rectangle Rail Adjustable Corner 0-45°
Dikdörtgen Kúpeşte Ayarlı Dönüş Küresi 0-45°

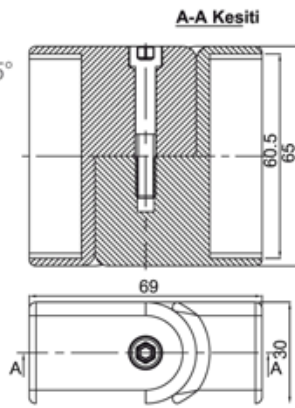

LS 614B

60x25

Rectangle Rail Adjustable Corner 0-45°+90°
Dikdörtgen Kúpeşte Ayarlı Dönüş Küresi 0-45°+90°

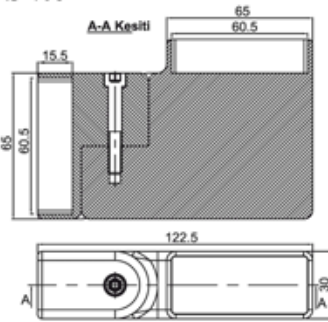
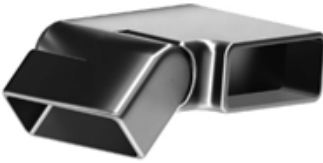

LS 801

90° Elbow For Rectangular Handrail
Dikdörtgen Kúpeşte 90° Dönüş

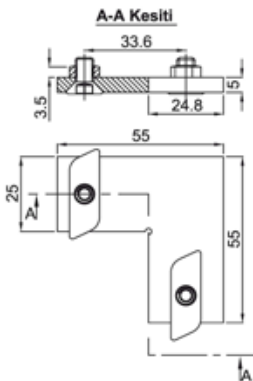

18-127-018
18-119-020
18-120-020

LS 801A

90° Elbow For Rectangular Handrail
Dikdörtgen Kúpeşte 90° Dönüş



18-127-018
18-119-020
18-120-020

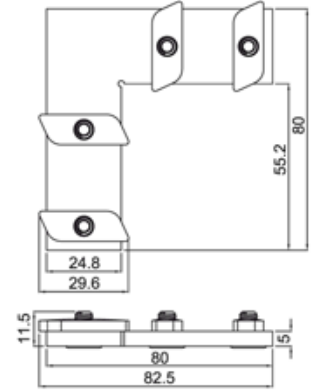

LS 801B

80x30

90° Corner Joint Plate
90° Köşe Birleşim Sacı



18-119-020

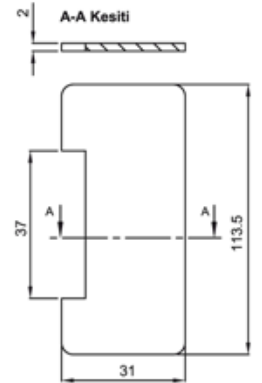

LS 801C

80x30

90° Corner Joint Plate
90° Köşe Birleşim Sacı

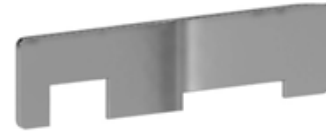

18-120-020

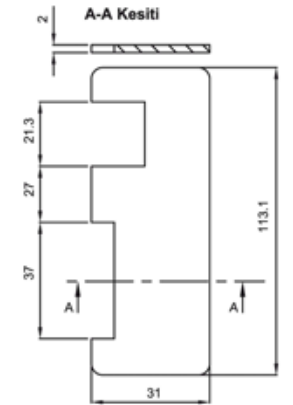

LS 801D

90° Corner Joint Plate
90° Köşe Birleşim Destek Sacı

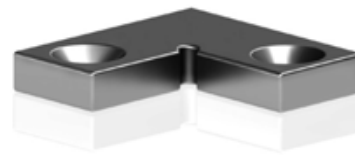

18-120-020

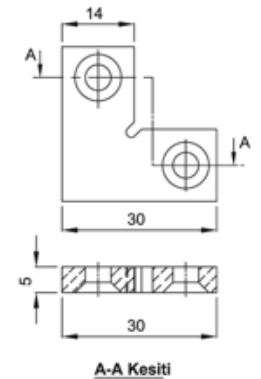

LS 802

45° Elbow For Rectangular Handrail
Dikdörtgen Küpeşte 45° Dönüş

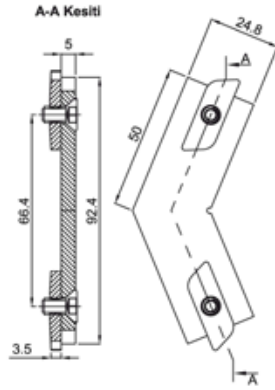

18-127-018
18-119-020
18-120-020

LS 802B

80x30

45° Corner Joint Plate
45° Köşe Birleşim Sacı

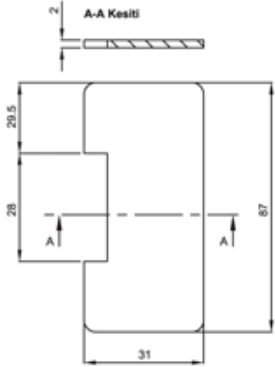
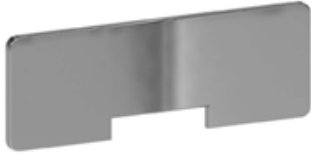

18-119-020

LS 802C

80x30

45° Corner Joint Plate
45° Köşe Birleşim Sacı

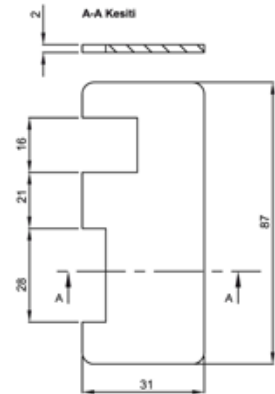
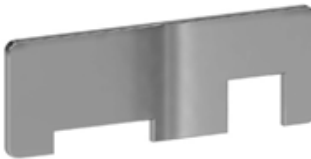

18-120-020

LS 804

80x30

Adjustable Elbow For Rectangular Handrail
Dikdörtgen Küpeşte Ayarlı Dönüş Küresi 45°

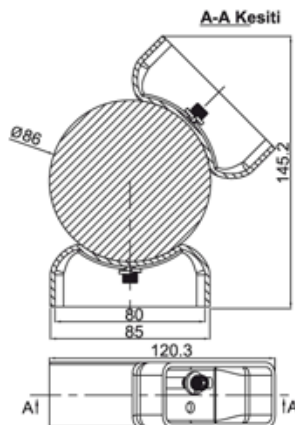
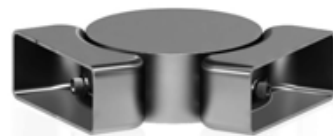

18-119-020
18-120-020

LA 611

Middle Joint
Ara Bağlantı

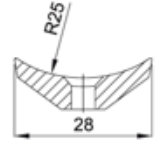
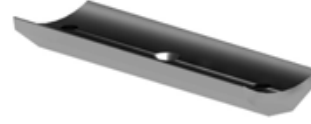

18-128-018

LA 751

75

Column Ground Adapter
Kare Baba Zemin Bağlantı Adaptör

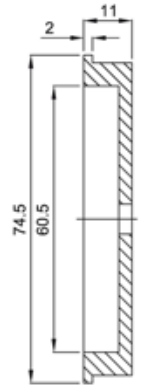

18-125-016

LA 801

Middle Joint
Ara Bağlantı

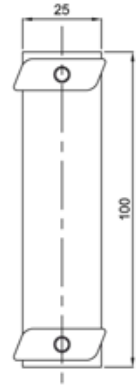

18-127-018
18-119-020
18-120-020

LV 301

Gasgets
Fıtil



18-120-020
18-122-00

applicationdetails

uygulamadetayları

application details / uygulamadetaiları

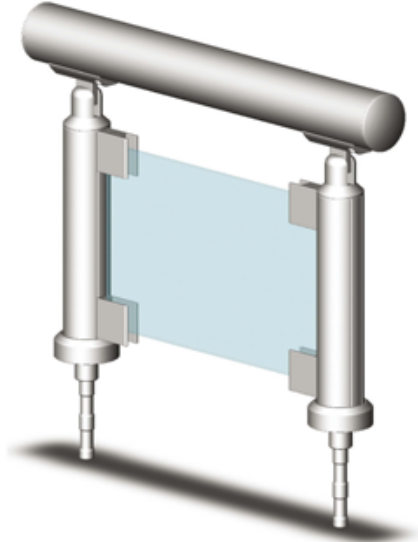
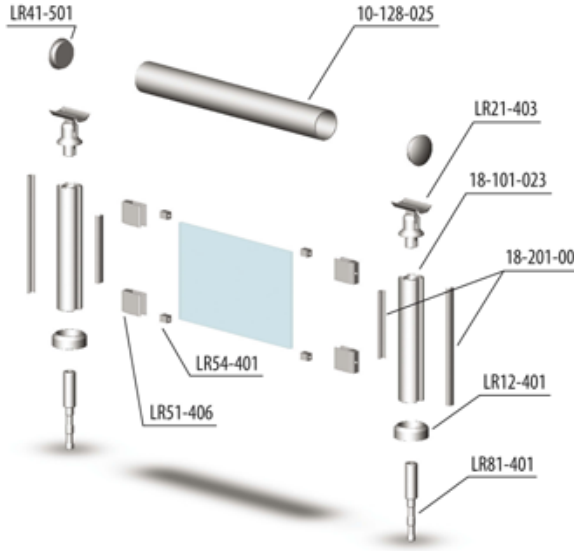

Code/Kod	Description/Açıklama
10-128-025	Ø 50 Tube Profile / 50'lik Boru Profili
18-101-023	Ø 40 Column Profile / 40'lik Dikme Profili
18-201-00	Column To Rail Profile (Ø 40) / 40'lik Dikme Çıta Profili
LR21-403	50 mm Crescent Conn. to 40 mm Strut (40x50) / 40'lik Dikmeye 50'lik Ay Bağlantı
LR12-401	40 mm Strut Flange / 40'lik Dikme Flanşı

Code/Kod	Description/Açıklama
LR41-501	50 mm Pipe Plug / 50'lik Boru Tapası
LR51-406	40 mm Strut Glass Holder / 40'lik Dikme Arası Cam Tutucu
LR54-401	Glass Stopper / Cam Takozu
LR81-401	40 mm Strut Anchor 14 cm / 40'lik Ankraj Demiri 14 cm

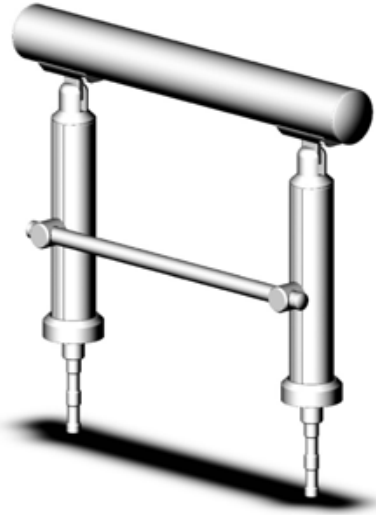
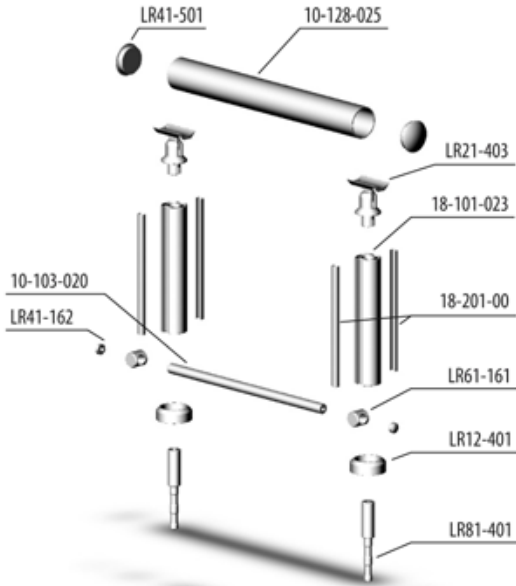

Code/Kod	Description/Açıklama
10-128-025	Ø50 Tube Profile / 50'lik Boru Profili
18-101-023	Ø40 Column Profile / 40'lik Dikme Profili
18-201-00	Column To Rail Profile (Ø40) / 40'lik Dikme Çıta Profili
10-103-020	Ø16 Tube Profile / 16'lik Boru Profili
LR21-403	50mm Crescent Conn. to 40 mm Strut (40x50) / 40'lik Dikmeye 50'lik Ay Bağlantı

Code/Kod	Description/Açıklama
LR12-401	40mm Strut Flange / 40'lik Dikme Flanşı
LR41-501	50mm Pipe Plug / 50'lik Boru Tapası
LR41-162	16mm Pipe Plug (16x2) / 16'lik Boru Tapası (16x2)
LR61-161	16mm Pipe Holder / 16'lik Tutamak Kurtağızlı
LR81-401	40mm Strut Anchor 14cm / 40'lik Ankraj Demiri 14 cm

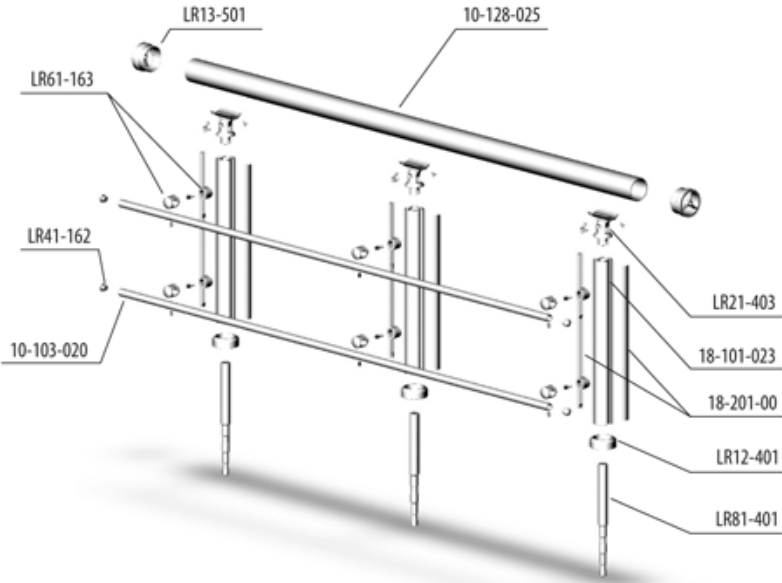

Code/Kod	Description/Açıklama
10-128-025	Ø 50 Tube Profile / 50'lik Boru Profili
18-101-023	Ø 40 Column Profile / 40'lik Dikme Profili
18-201-00	Column To Rail Profile (Ø 40) / 40'lik Dikme Çita Profili
10-103-020	Ø 16 Tube Profile / 16'lik Boru Profili
LR21-403	50 mm Crescent Conn. to 40mm Strut (40x50) / 40'lik Dikmeye 50'lik Ay Bağlantı

Code/Kod	Description/Açıklama
LR12-401	40 mm Strut Flange / 40'lik Dikme Flanşı
LR13-501	50 mm Pipe Flange / 50'lik Boru Flanşı
LR61-163	16 mm Double Holder / 16'lik Tutamak Çifti
LR41-162	16 mm Pipe Plug (16x2) / 16'lik Boru Tapası (16x2)
LR81-401	40 mm Strut Anchor 14 cm / 40'lik Ankraj Demiri 14cm

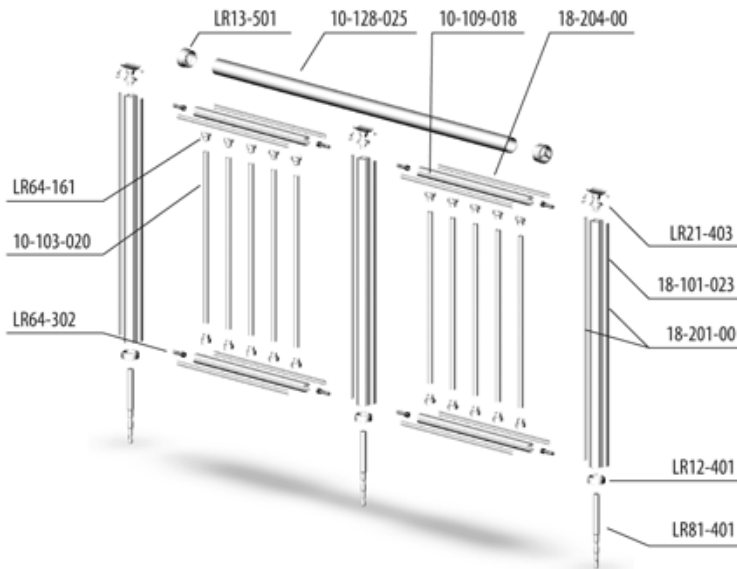

Code/Kod	Description/Açıklama
10-128-025	Ø 50 Tube Profile / 50'lik Boru Profili
18-109-018	Ø 30 Column Profile / 30'lik Dikme Profili
18-204-00	Column To Rail Profile (Ø 30) / 30'luk Dikme Çita Profili
18-101-023	Ø 40 Column Profile / 40'lik Dikme Profili
18-201-00	Column To Rail Profile (Ø 40) / 40'lik Dikme Çita Profili
10-103-020	Ø 16 Tube Profile / 16'lik Boru Profili

Code/Kod	Description/Açıklama
LR21-403	50 mm Crescent Conn. to 40 mm Strut (40x50) / 40'lik Dikmeye 50'lik Ay Bağlantı
LR12-401	40 mm Strut Flange / 40'lik Dikme Flanşı
LR13-501	50 mm Pipe Flange / 50'lik Boru Flanşı
LR64-161	16 mm Pipe Intercom. to 30 Pipe (16x30) / 16'lik Boruya Göre 30'luk Kurtağzı
LR64-302	30 mm Strut Interconn. to 40 mm Pipe (30x40) / 30'lik Dikmeye Göre 40'lik Kurtağzı
LR81-401	40 mm Strut Anchor 14cm / 40'lik Ankraj Demiri 14cm

application details / uygulamadetaayları

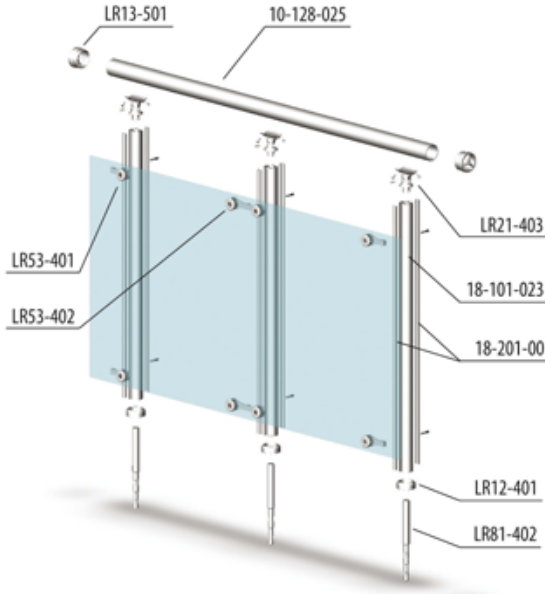

Code/Kod	Description/Açıklama
10-128-025	Ø 50 Tube Profile / 50'lik Boru Profili
18-101-023	Ø 40 Column Profile / 40'lık Dikme Profili
18-201-00	Column To Rail Profile (Ø 40) / 40'lık Dikme Çıta Profili
LR21-403	50 mm Crescent Conn. to 40 mm Strut (40x50) / 40'lık Dikmeye 50'lik Ay Bağlantı
LR12-401	40 mm Strut Flange / 40'lık Dikme Flaşı

Code/Kod	Description/Açıklama
LR13-501	50 mm Pipe Flange / 50'lik Boru Flaşı
LR53-401	40 mm Single Spider Glass Holder / 40'lık Tekli Spider Cam Tutamağı
LR53-402	40 mm Double Spider Glass Holder / 40'lık Çiftli Spider Cam Tutamağı
LR81-402	40 mm Strut Anchor 24 cm / 40'lık Ankraj Demiri 24 cm

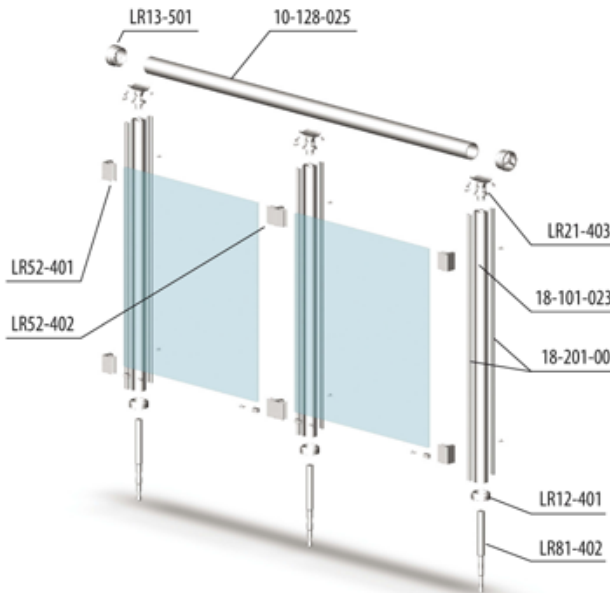

Code/Kod	Description/Açıklama
10-128-025	Ø 50 Tube Profile / 50'lik Boru Profili
18-101-023	Ø 40 Column Profile / 40'lık Dikme Profili
18-201-00	Column To Rail Profile (Ø 40) / 40'lık Dikme Çıta Profili
LR21-403	50 mm Crescent Conn. to 40 mm Strut (40x50) / 40'lık Dikmeye 50'lik Ay Bağlantı
LR12-401	40 mm Strut Flange / 40'lık Dikme Flaşı

Code/Kod	Description/Açıklama
LR13-501	50 mm Pipe Flange / 50'lik Boru Flaşı
LR52-401	40 mm Single Glass Holder / 40'lık Tekli Cam Tutamağı
LR52-402	40 mm Double Glass Holder / 40'lık Çiftli Cam Tutamağı
LR81-402	40 mm Strut Anchor 24 cm / 40'lık Ankraj Demiri 24 cm

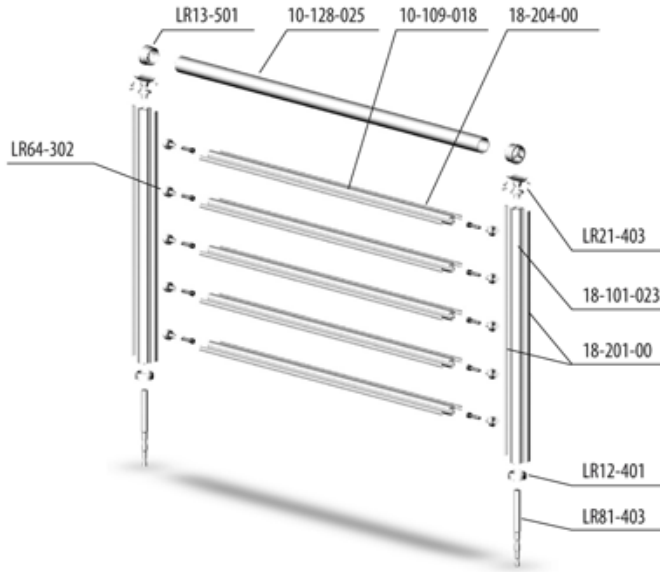

Code/Kod	Description/Açıklama
10-128-025	Ø50 Tube Profile / 50'lik Boru Profili
18-109-018	Ø30 Column Profile / 30'luk Dikme Profili
18-204-00	Column To Rail Profile (Ø30) / 30'luk Dikme Çıta Profili
18-101-023	Ø40 Column Profile / 40'luk Dikme Profili
18-201-00	Column To Rail Profile (Ø40) / 40'luk Dikme Çıta Profili

Code/Kod	Description/Açıklama
LR21-403	50mm Crescent Conn. to 40mm Strut (40x50) / 40'luk Dikmeye 50'lik Ay Bağlantı
LR12-401	40mm Strut Flange / 40'luk Dikme Flanşı
LR13-501	50mm Pipe Flange / 50'lik Boru Flanşı
LR64-302	30mm Strut Interconn. to 40mm Pipe (30x40) / 30'luk Dikmeye 40'lik Kurtağzı
LR81-403	40mm Strut Anchor 22cm / 40'luk Ankraj Demiri 22cm

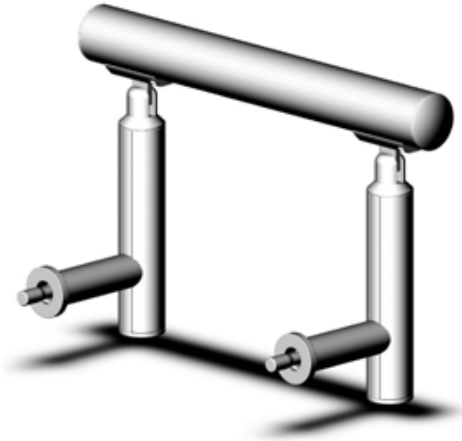
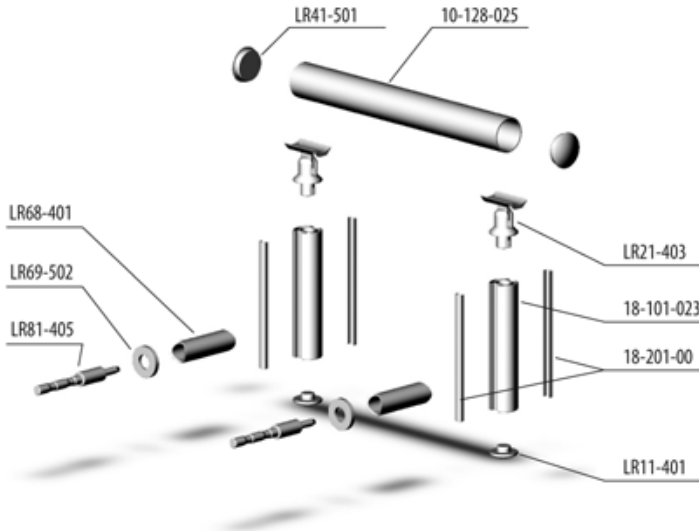

Code/Kod	Description/Açıklama
10-128-025	Ø50 Tube Profile / 50'lik Boru Profili
18-101-023	Ø40 Column Profile / 40'luk Dikme Profili
18-201-00	Column To Rail Profile (Ø40) / 40'luk Dikme Çıta Profili
LR21-403	50mm Crescent Conn. to 40mm Strut (40x50) / 40'luk Dikmeye 50'lik Ay Bağlantı
LR11-401	40mm External Screwed Flange / 40'luk Dıştan Vidalı Flanş

Code/Kod	Description/Açıklama
LR41-501	50mm Pipe Plug / 50'lik Boru Tapası
LR68-401	40mm Strut Wall Interconnection / 40'luk Dikmeye Duvar Ara Bağlantı
LR69-502	Wall Washer / Duvar Pulu
LR81-405	Anchor From Side / Yandan Ankraj Demiri

application details / uygulamadetaiları

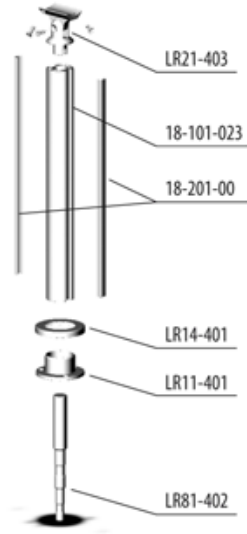

Code/Kod	Description/Açıklama
18-101-023	Ø40 Column Profile / 40'lık Dikme Profili
18-201-00	Column To Rail Profile (Ø40) / 40'lık Dikme Çıta Profili
LR21-403	50mm Cressent Conn. to 40mm Strut (40x50) / 40'lık Dikmeye 50'lik Ay Bağlantı

Code/Kod	Description/Açıklama
LR11-401	40mm External Screwed Flange / 40'lık Dıştan Vidalı Flanş
LR14-401	40mm External Screwed Flange Cop Interlaced / 40'lık Dıştan Vidalı Flanş Kapağı
LR81-402	40mm Strut Anchor 24cm / 40'lık Ankraj Demiri 24 cm

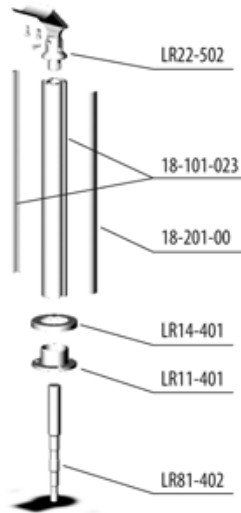

Code/Kod	Description/Açıklama
18-101-023	Ø40 Column Profile / 40'lık Dikme Profili
18-201-00	Column To Rail Profile (Ø40) / 40'lık Dikme Çıta Profili
LR22-502	50mm Angled 1 Conn. to 40mm Strut / 40'lık Dikmeye 50'lik Açılı Bağlantı

Code/Kod	Description/Açıklama
LR11-401	40mm External Screwed Flange / 40'lık Dıştan Vidalı Flanş
LR14-401	40mm External Screwed Flange Cop Interlaced / 40'lık Dıştan Vidalı Flanş Kapağı
LR81-402	40mm Strut Anchor 24cm / 40'lık Ankraj Demiri 24cm

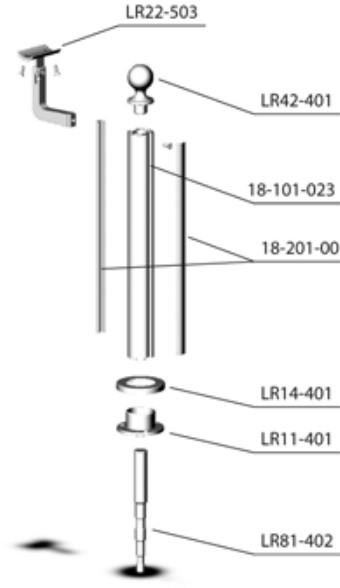

Code/Kod	Description/Açıklama
18-101-023	Ø40 Column Profile / 40'lık Dikme Profili
18-201-00	Column To Rail Profile (Ø40) / 40'lık Dikme Çita Profili
LR42-401	40mm Strut Decorative Plug / 40'lık Dikme Dekorlu Tapa
LR22-503	Sideway Screwd L Connection Set / Yandan Vidalı L Bağlantı Takımı

Code/Kod	Description/Açıklama
LR11-401	40mm External Screwd Flange / 40'lık Dıştan Vidalı Flanş
LR14-401	40mm External Screwd Flange Cop Interlaced / 40'lık Dıştan Vidalı Flanş Kapağı
LR81-402	40mm Strut Anchor 24 cm / 40'lık Ankraj Demiri 24cm

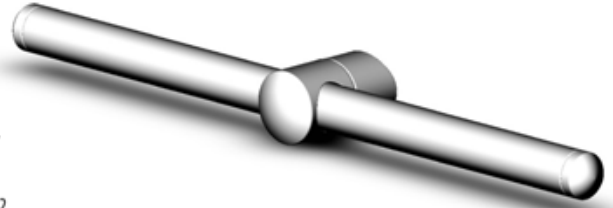
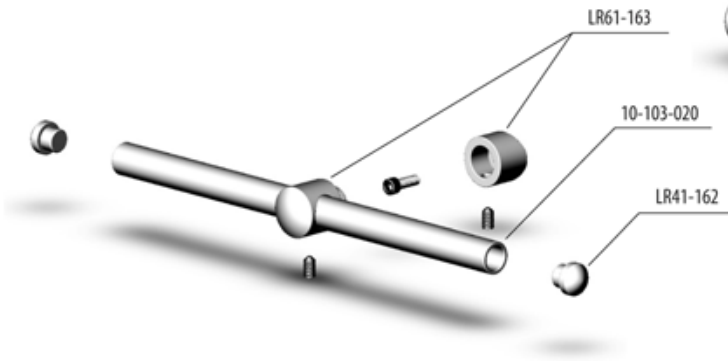

Code/Kod	Description/Açıklama
10-103-020	Ø16 Tube Profile / 16'lık Boru Profili
LR61-163	16mm Double Holder / 16'lık Tutamak Çiftli
LR41-162	16mm Pipe Plug (16x2) / 16'lık Boru Tapası 16x2

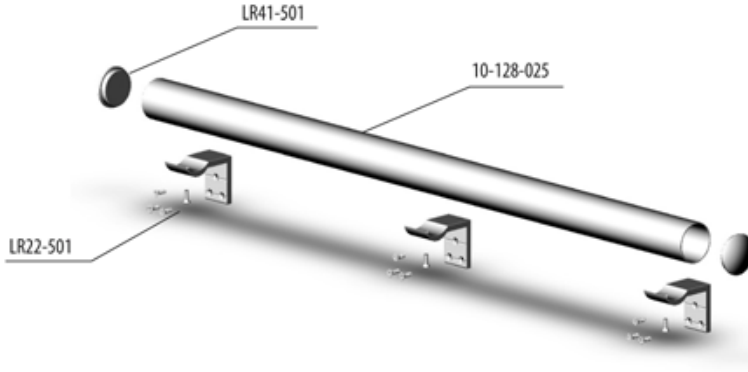

Code/Kod	Description/Açıklama
10-128-025	Ø50 Tube Profile / 50'lik Boru Profili
LR22-501	L-Connection / L Bağlantı
LR41-501	50mm Pipe Plug / 50'lik Boru Tapası

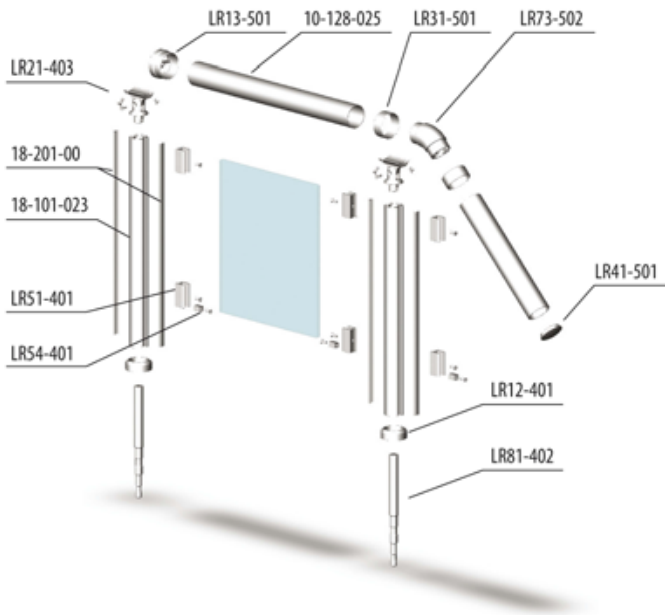

Code/Kod	Description/Açıklama
10-128-025	Ø50 Tube Profile / 50'lik Boru Profili
18-101-023	Ø40 Column Profile / 40'lik Dikme Profili
18-201-00	Column To Rail Profile (Ø40) / 40'lik Dikme Çıta Profili
LR21-403	50mm Crescent Conn. to 40mm Strut (40x50) / 40'lik Dikmeye 50'lik Ay Bağlantı
LR12-401	40mm Strut Flange / 40'lik Dikme Flanşı
LR13-501	50mm Pipe Flange / 50'lik Boru Flanşı

Code/Kod	Description/Açıklama
LR73-502	50mm 1/8 Bend / 50'lik 1/8 Simit Bağlı
LR31-501	50mm Ring / 50'lik Bilezik
LR41-501	50mm Pipe Plug / 50'lik Boru Tapası
LR51-401	40mm Pipe Glass Holder / 40'lik Boru Cam Tutamağı
LR54-401	Glass Stopper / Cam Takozu
LR81-402	40mm Strut Anchor 24 cm / 40'lik Ankraj Demiri 24 mm

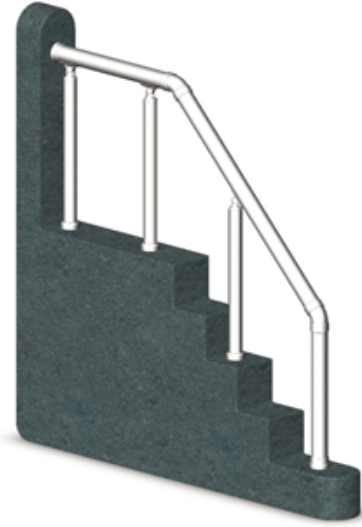
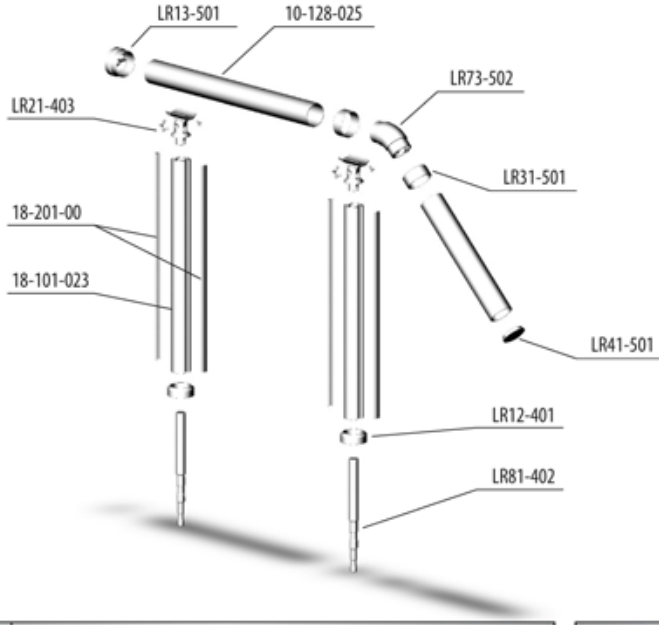

Code/Kod	Description/Açıklama
10-128-025	Ø50 Tube Profile / 50'lik Boru Profili
18-101-023	Ø40 Column Profile / 40'lik Dikme Profili
18-201-00	Column To Rail Profile (Ø40) / 40'lik Dikme Çıtası
LR21-403	50mm Crescent Conn. to 40mm Strut (40x50) / 40'lik Dikmeye 50'lik Ay Bağlantı
LR12-401	40mm Strut Flange / 40'lik Dikme Flaşı

Code/Kod	Description/Açıklama
LR13-501	50mm Pipe Flange / 50'lik Boru Flaşı
LR73-502	50mm 1/8 Bend / 50'lik 1/8 Simit Bağlı
LR31-501	50mm Ring / 50'lik Bilezik
LR41-501	50mm Pipe Plug / 50'lik Boru Tapası
LR81-402	40mm Strut Anchor 24cm / 40'lik Ankraj Demiri 24cm

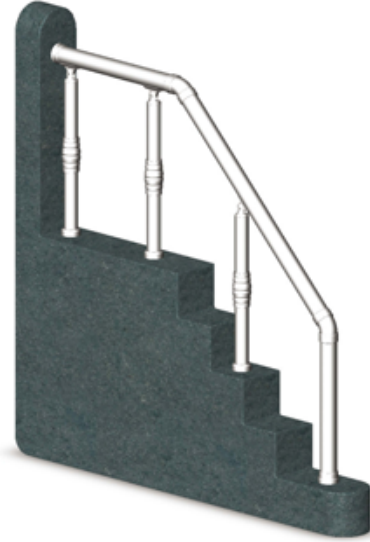
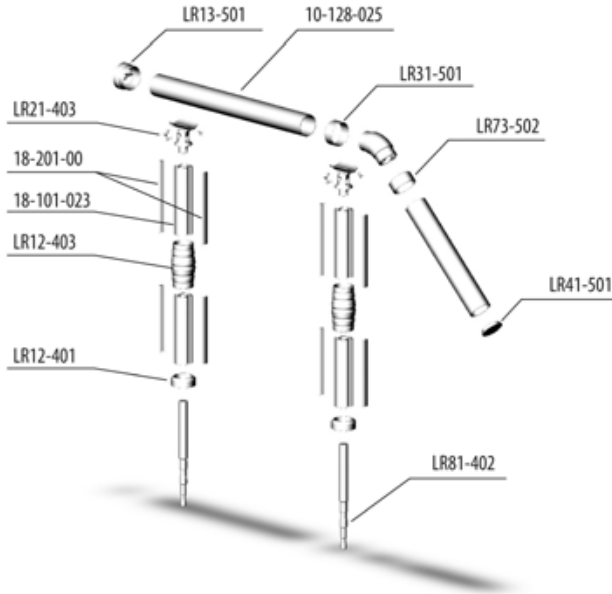

Code/Kod	Description/Açıklama
10-128-025	Ø50 Tube Profile / 50'lik Boru Profili
18-101-023	Ø40 Column Profile / 40'lik Dikme Profili
18-201-00	Column To Rail Profile (Ø40) / 40'lik Dikme Çıta Profili
LR21-403	50mm Crescent Conn. to 40mm Strut (40x50) / 40'lik Dikmeye 50'lik Ay Bağlantı
LR12-401	40mm Strut Flange / 40'lik Dikme Flaşı
LR13-501	50mm Pipe Flange / 50'lik Boru Flaşı

Code/Kod	Description/Açıklama
LR73-502	50mm 1/8 Bend / 50'lik 1/8 Simit Bağlı
LR31-501	50mm Ring / 50'lik Bilezik
LR12-403	40mm Decorated Strut Flange / 40'lik Dekorlu Dikme Flaşı
LR41-501	50mm Pipe Plug / 50'lik Boru Tapası
LR81-402	40mm Strut Anchor 24cm / 40'lik Ankraj Demiri 24cm

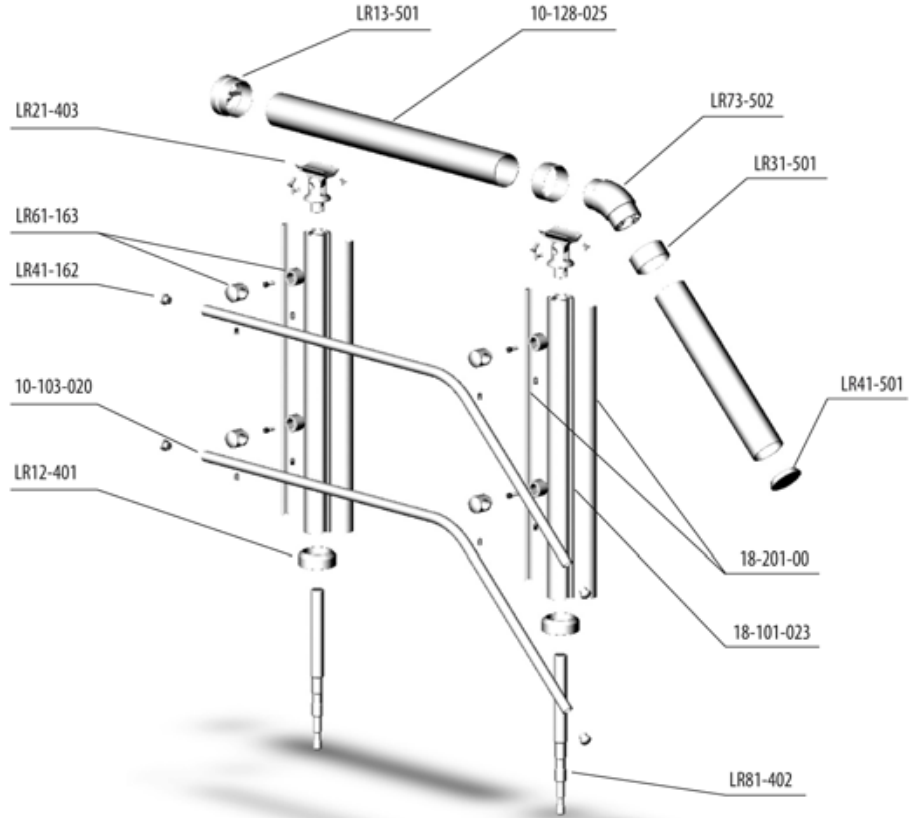
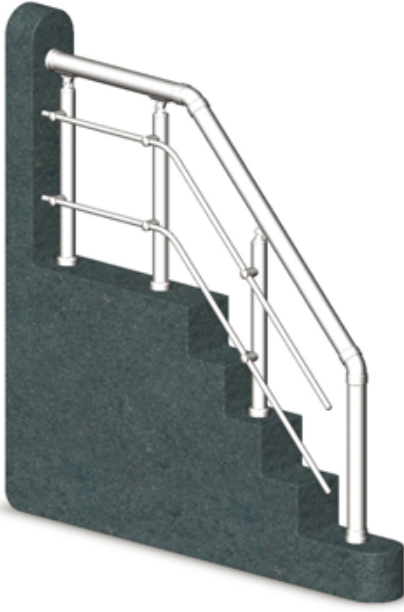

Code/Kod	Description/Açıklama
10-128-025	Ø50 Tube Profile / 50'lik Boru Profili
18-101-023	Ø40 Column Profile / 40'lık Dikme Profili
18-201-00	Column To Rail Profile (Ø40) / 40'lık Dikme Çıta Profili
10-103-020	16 Tube Profile / 16'lık Boru Profili
LR21-403	50mm Crescent Conn. to 40mm Strut (40x50) / 40'lık Dikmeye 50'lik Ay Bağlantı
LR12-401	40mm Strut Flange / 40'lık Dikme Flanşı
LR73-502	50mm 1/8 Bend / 50'lik 1/8 Simit Bağlı

Code/Kod	Description/Açıklama
LR31-501	50mm Ring / 50'lik Bilezik
LR13-501	50mm Pipe Flange / 50'lik Boru Flanşı
LR61-163	16mm Double Holder / 16'lık Tutamak Çiftli
LR41-162	16mm Pipe Plug (16x2) / 16'lık Boru Tapası (16x2)
LR41-501	16mm Pipe Plug / 50'lik Boru Tapası
LR81-402	40mm Strut Anchor 24cm / 40'lık Ankraj Demiri 24cm

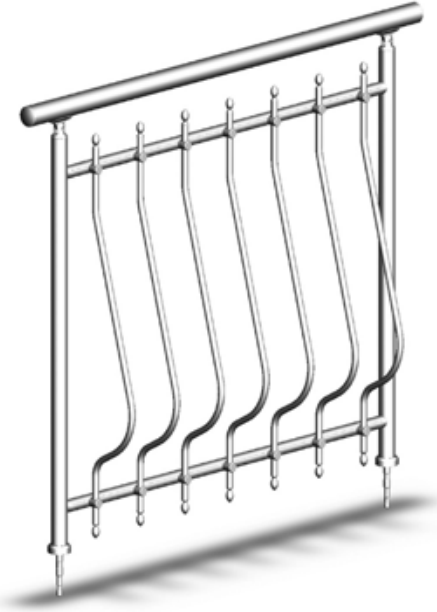
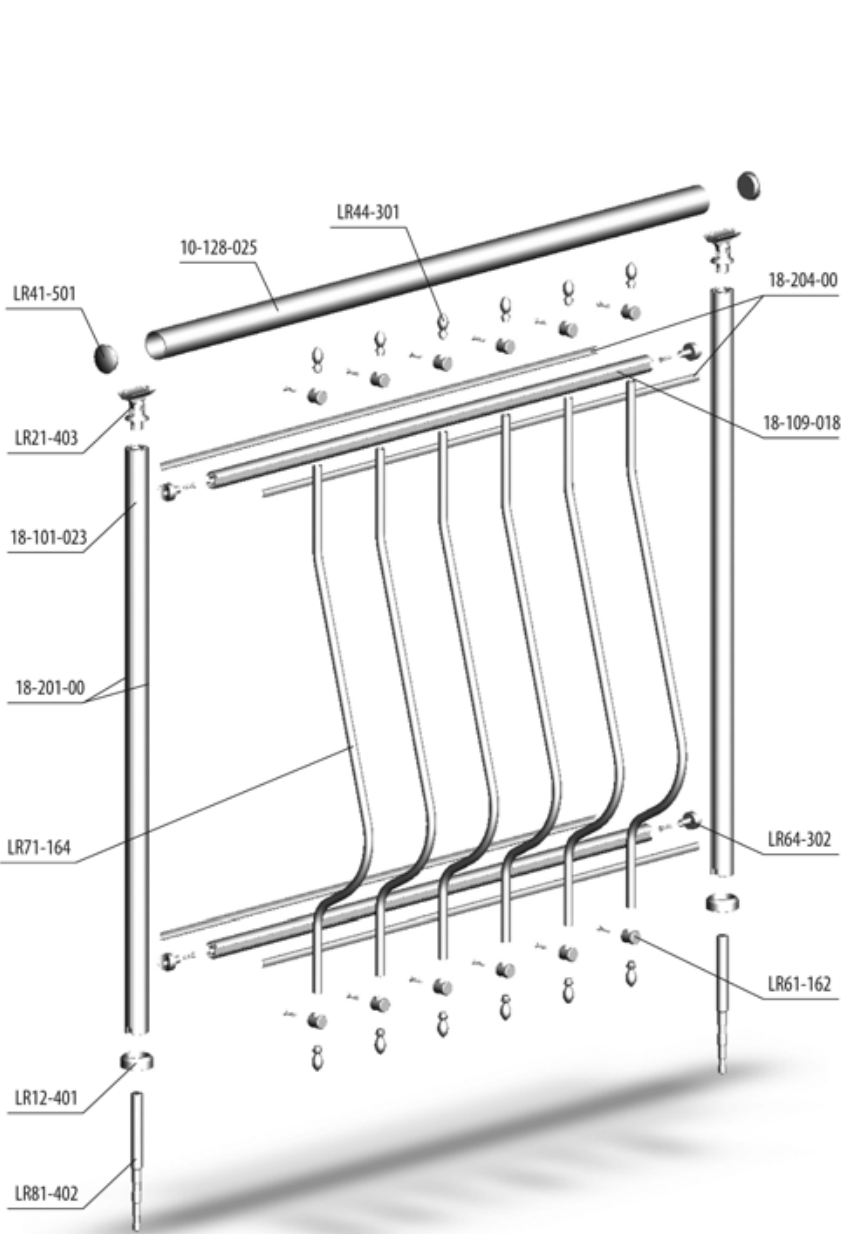

Code/Kod	Description/Açıklama
10-128-025	Ø50 Tube Profile / 50'lik Boru Profili
18-101-023	Ø40 Column Profile / 40'lik Dikme Profili
18-109-018	Ø30 Column Profile / 30'luk Dikme Profili
18-201-00	Column To Rail Profile (Ø40) / 40'lik Dikme Çıta Profili
18-204-00	Column To Rail Profile (Ø30) / 30'luk Dikme Çıta Profili
LR12-401	40mm Strut Flange / 40'lik Dikme Flaşı
LR21-403	50mm Crescent Conn. to 40mm Strut (40x50) / 40'lik Dikmeye 50'lik Ay Bağlantı

Code/Kod	Description/Açıklama
LR41-501	50mm Pipe Plug / 50'lik Boru Tapası
LR44-161	16mm Decorative Plug / 16'lik Boruya Dekorlu Tapa
LR61-162	16mm Pipe Holder / 16'lik Tutamak
LR64-302	30mm Strut Interconnection To 40mm Pipe / 30'luk Dikmeye Göre 40'lik Kurtağz
LR71-164	16mm Decorative Security Profile / 16'lik Dekorlu Emniyet Profili
LR81-402	40mm Strut Anchor 24cm / 40'lik Ankraj Demiri 24cm

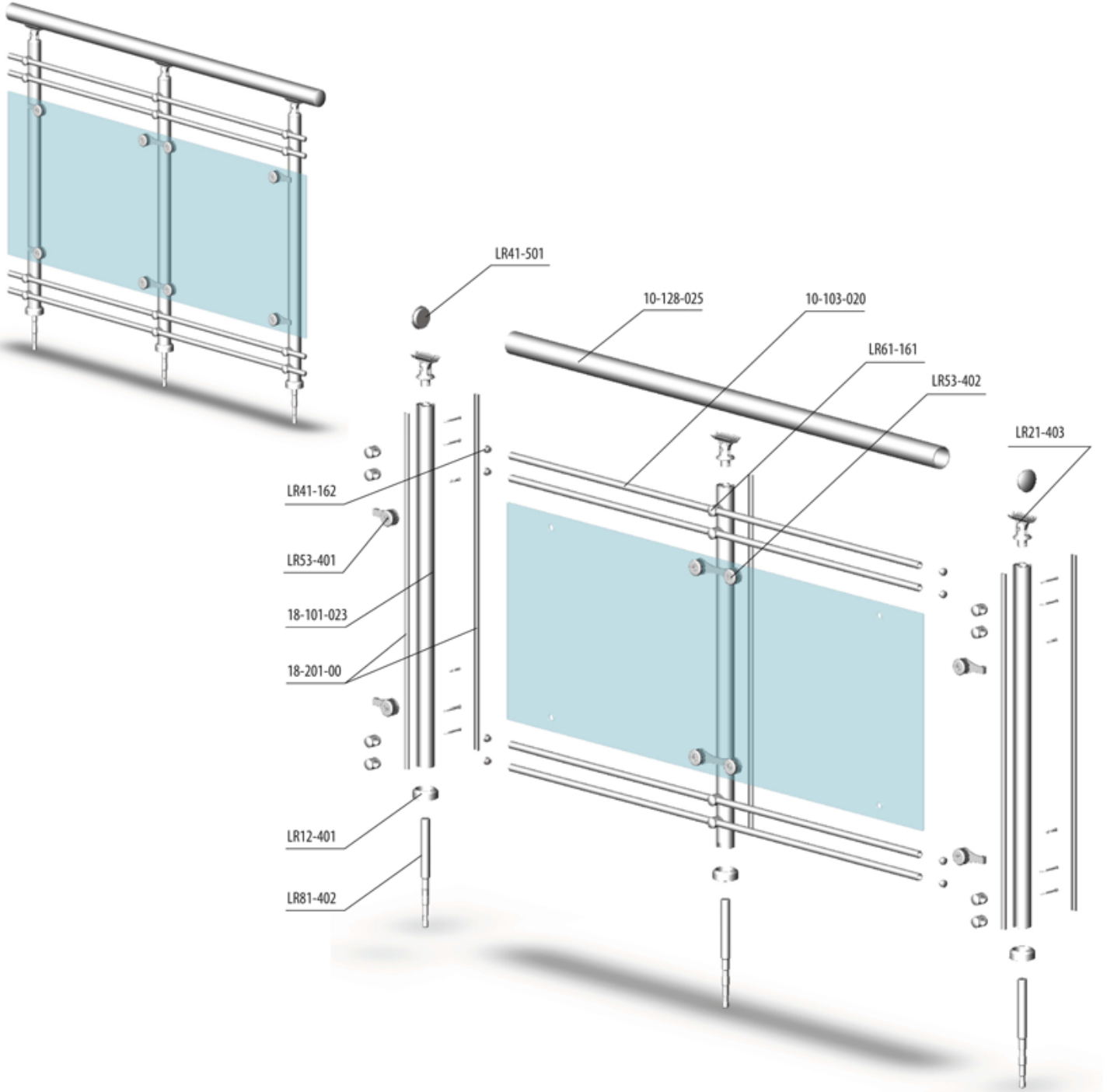

Code/Kod	Description/Açıklama
10-128-025	Ø50 Tube Profile / 50'lık Boru Profili
18-101-023	Ø40 Column Profile / 40'lık Dikme Profili
18-201-00	Column To Rail Profile (Ø40) / 40'lık Dikme Çita Profili
10-103-020	Ø16 Tube Profile / 16'lık Boru Profili
LR12-401	40mm Strut Flange / 40'lık Dikme Flanşı
LR21-403	50mm Crescent Conn. To 40mm Strut (40x50) / 40'lık Dikmeye 50'lık Ay Bağlantı

Code/Kod	Description/Açıklama
LR41-501	50mm Pipe Plug / 50'lık Boru Tapası
LR41-162	16mm Pipe Plug (16x2) / 16'lık Boru Tapası
LR61-161	16mm Pipe Holder / 16'lık Tutamak Kurtağızlı
LR53-401	40mm Single Spider Glass Holder / 40'lık Tekli Spider Cam Tutamağı
LR53-402	40mm Double Spider Glass Holder / 40'lık Çiftli Spider Cam Tutamağı
LR81-402	40mm Strut Anchor 24cm / 40'lık Ankraj Demiri 24cm

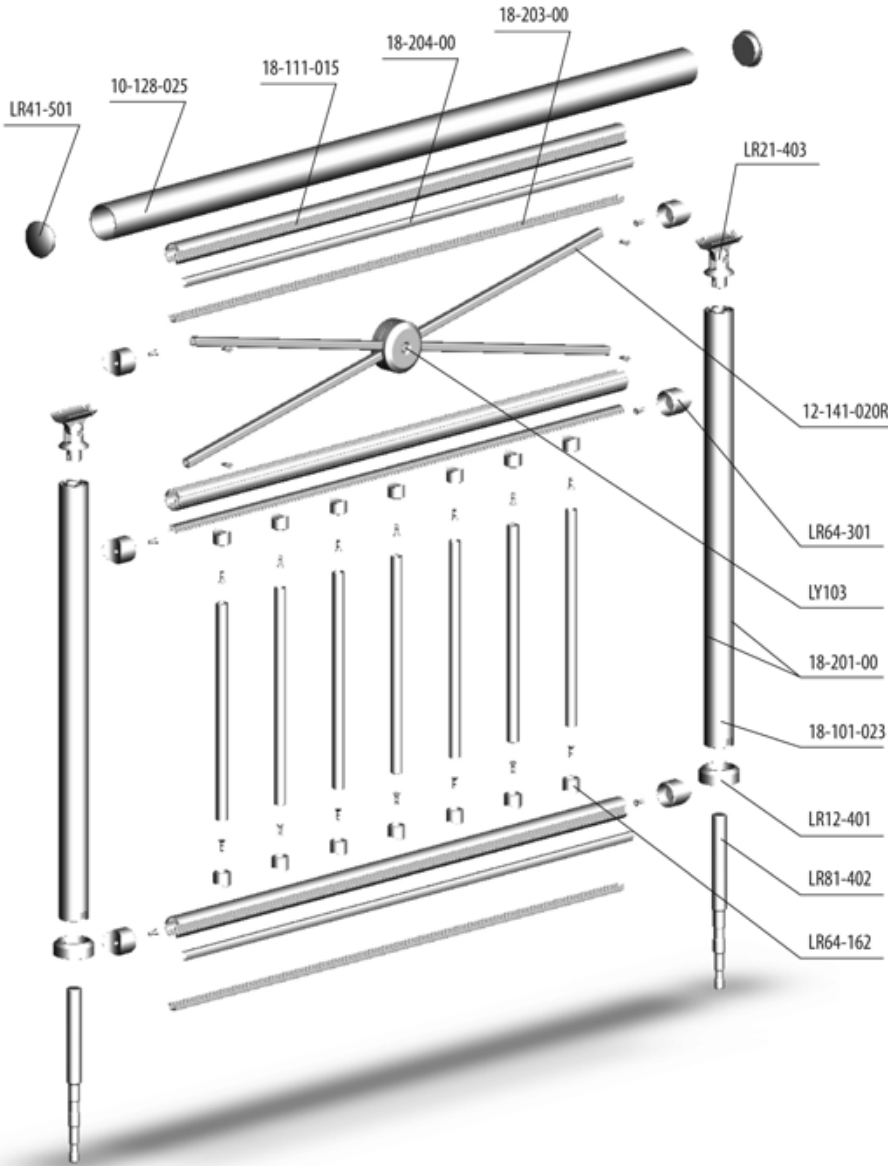

Code/Kod	Description/Açıklama
10-128-025	Ø50 Tube Profile / 50'lik Boru Profili
18-101-023	Ø40 Column Profile / 40'lik Dikme Profili
18-201-00	Column To Rail Profile (Ø40) / 40'lik Dikme Çita Profili
18-111-015	Ø30 Column Profile / 30'luk Dikme Profili
18-203-00	Column To Rail Profile(Ø30) / 30'luk Dikme Çita Profili
18-204-00	Column To Rail Profile(Ø30) / 30'luk Dikme Çita Profili
18-141-020R	12 Box Profile / 12'lik Kutu Profili

Code/Kod	Description/Açıklama
LR21-403	50mm Crescent Conn. To 40mm Strut (40x50) / 40'lik Dikmeye 50'lik Ay Bağlantı
LR41-501	50mm Pipe Plug / 50'lik Boru Tapası
LR64-301	30mm Pipe Interconn. To 40mm Pipe / 30'luk Boruya 40'lik Kurtağzı
LR12-401	40mm Strut Flange / 40'lik Dikme Flaşzı
LR64-162	30mm Interconn. For 16mm Pipe / 16'lik Boruya 30'lik Kurtağzı
LY103	12x12mm Profile Diagonal Center Holder / 12x12mm Kare Çapraz Motif Göbeđi
LR81-402	40mm Strut Anahtar 24cm / 40'lik Ankraj Demiri 24cm

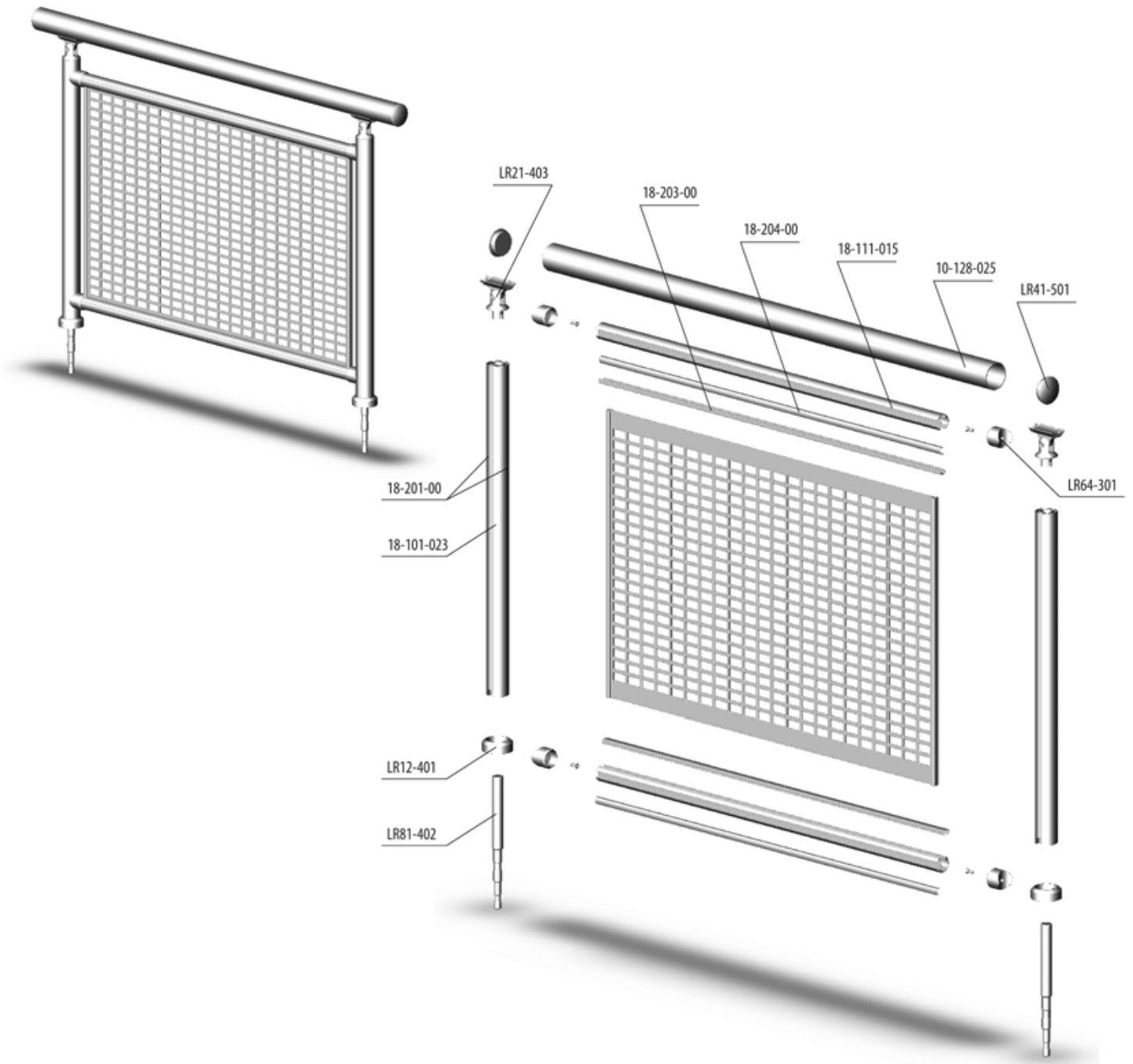

Code/Kod	Description/Açıklama
10-128-025	Ø50 Tube Profile / 50'lik Boru Profili
18-101-023	Ø40 Column Profile / 40'lık Dikme Profili
18-201-00	Column To Rail Profile (Ø40) / 40'lık Dikme Çıta Profili
18-111-015	Ø30 Column Profile / 30'luk Dikme Profili
18-203-00	Column To Rail Profile (Ø30) / 30'luk Dikme Çıta Profili
18-204-00	Column To Rail Profile (Ø30) / 30'luk Dikme Çıta Profili

Code/Kod	Description/Açıklama
LR21-403	50mm Crescent Conn. To 40mm Strut (40x50) / 40'lık Dikmeye 50'lik Ay Bağlantı
LR41-501	50mm Pipe Plug / 50'lik Boru Tapası
LR64-301	30mm Pipe Interconn. To 40mm Pipe / 30'luk Boruya 40'lık Kurtağzı
LR12-401	40mm Strut Flange / 40'lık Dikme Flanşı
LR81-402	40mm Strut Anchor 24cm / 40'lık Ankraj Demiri 24cm

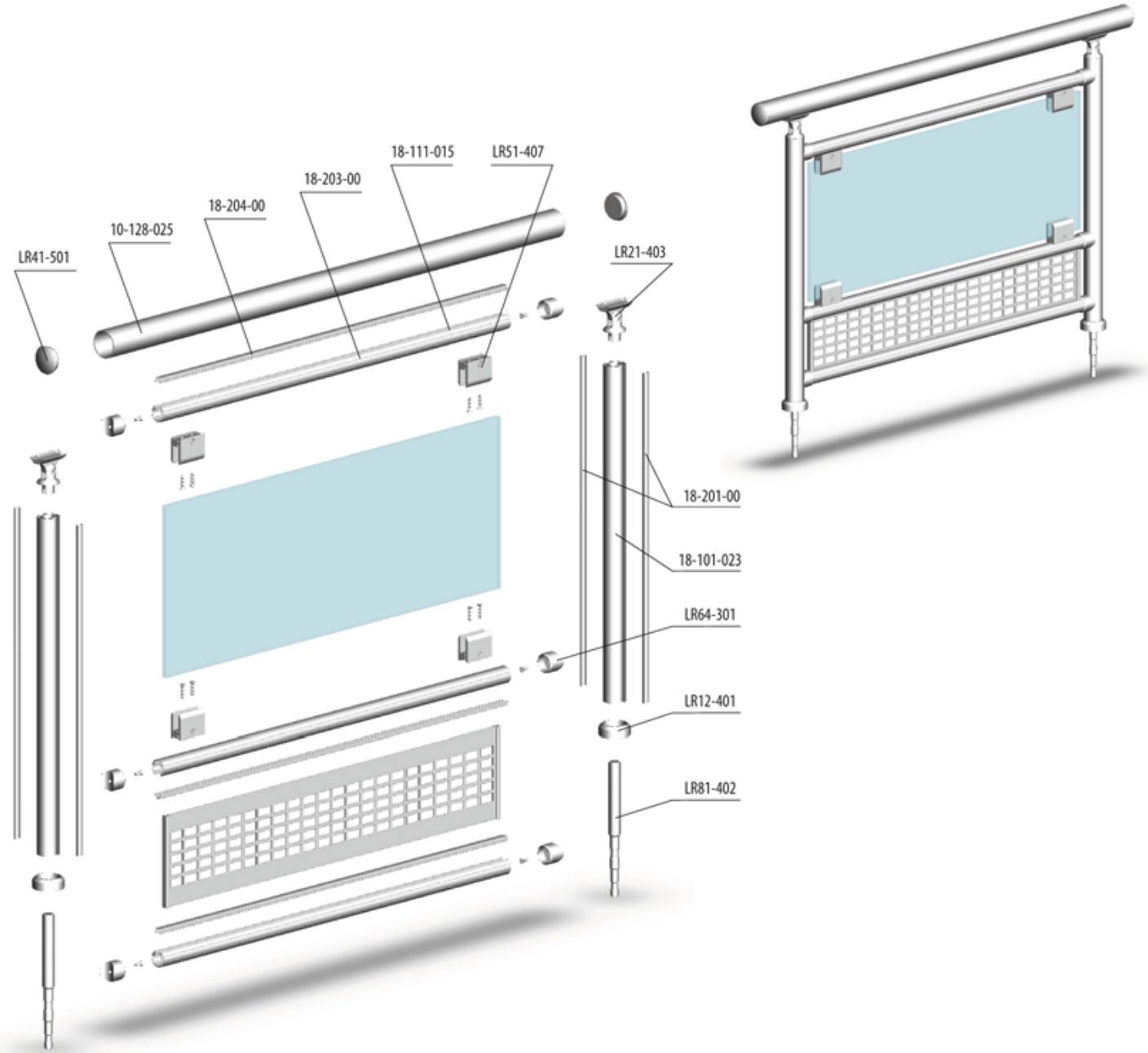

Code/Kod	Description/Açıklama
10-128-025	Ø50 Tube Profile / 50'lik Boru Profili
18-101-023	Ø40 Column Profile / 40'lik Dikme Profili
18-201-00	Column To Rail Profile (Ø40) / 40'lik Dikme Çıta Profili
18-111-015	Ø30 Column Profile / 30'luk Dikme Profili
18-203-00	Column To Rail Profile (Ø30) / 30'luk Dikme Çıta Profili
18-204-00	Column To Rail Profile (Ø30) / 30'luk Dikme Çıta Profili

Code/Kod	Description/Açıklama
LR21-403	50mm Crescent Conn. To 40mm Strut (40x50) / 40'lik Dikmeye 50'lik Ay Bağlantı
LR41-501	50mm Pipe Plug / 50'lik Boru Tapası
LR51-407	40mm Pipe Adjustable Glass Holder / 40'lik Boruya Ayarlı Cam Tutamağı
LR64-301	30mm Pipe Interconn. To 40mm Pipe (30x40) / 30'luk Boruya 40'lik Kurtağzı
LR12-401	40mm Strut Flange / 40'lik Dikme Flanşı
LR81-402	40mm Strut Anchor 24cm / 40'lik Ankraj Demiri 24cm

aplication details / uygulamadetaayları

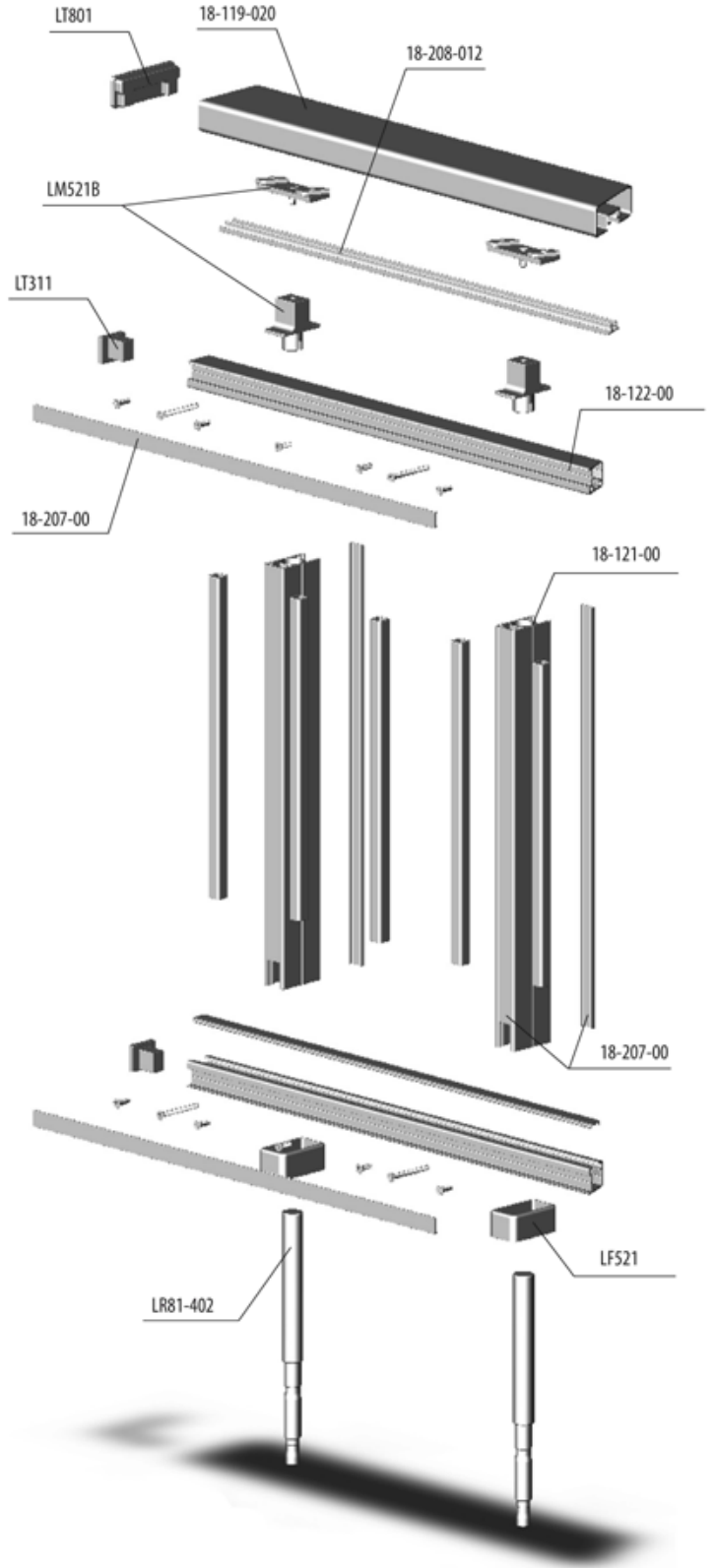
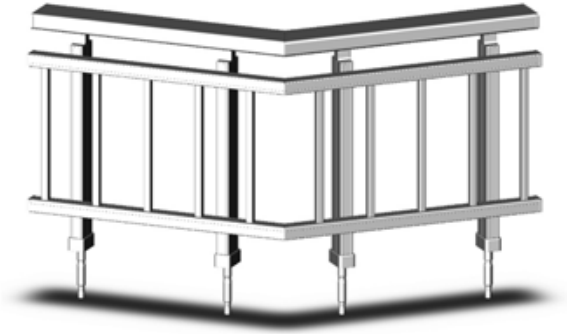

Code/Kod	Description/Açıklama
18-119-020	Handrail Profile / Küpeşte Profili
18-208-012	Cover Profile / Kapak Profili
18-122-00	Post Profile / Dikme Profili
18-121-00	Post Profile / Dikme Profili
18-207-00	Post Profiles / Dikme Çıta Profili

Code/Kod	Description/Açıklama
LM521B	Rectangular Post Rectangle Rail Joint / Dikdörtgen Dikme Dikdörtgen Küpeşte Mafsalı
LT801	Cap For 80x30mm Rectangular Handrail / 80x30mm Dikdörtgen Küpeşte Tapası
LT311	Cap For 30mm Rectangular Rail Profile / 30mm Dikdörtgen Ray Profil Tapası
LF521	Flange For Rectangular Post / Dikdörtgen Dikme Flanşı
LR81-402	40mm Strut Anchor 24cm / 40'lık Ankraj Demiri 24cm

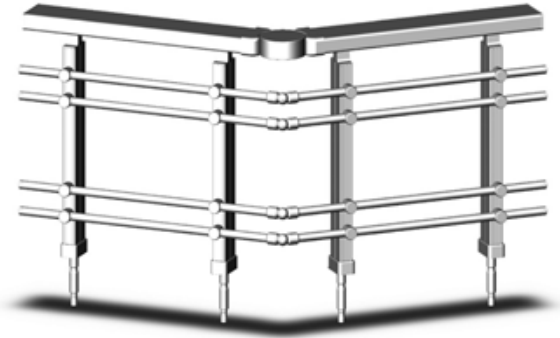
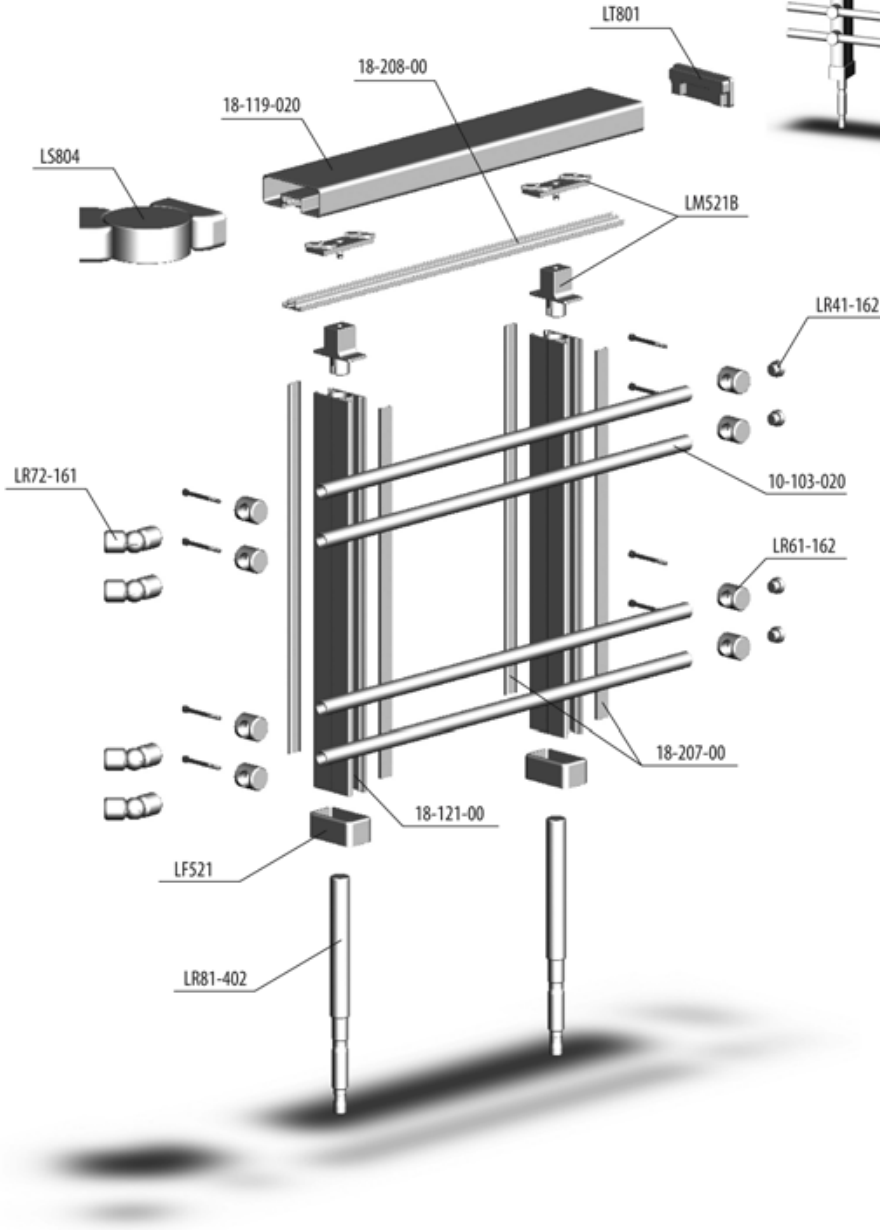

Code/Kod	Description/Açıklama
18-119-020	Handrail Profile / K�peşte Profili
18-208-00	Cover Profile / Kapak Profili
18-121-00	Post Profile / Dikme Profili
18-207-00	Cover Profile / Kapak Profili
10-103-020	Ø16 Tube Profile / 16'lık Boru Profili
LM521 B	Rectangular Post Rectangle Rail Joint / Dikdörtgen Dikme K�peşte Mafsalı

Code/Kod	Description/Açıklama
LT801	Cap For 80x30 Rectangular Handrail / 80x30 Dikdörtgen K�peşte Tapası
LR41-162	16mm Pipe Plug (16x2) / 16'lık Boru Tapası (16x2)
LR61-162	16mm Pipe Holder / 16'lık Tutamak
LR72-161	16mm Sphere Bend / 16'lık K�re Dirsek
LS804	Adjustable Elbow For 80x30mm Rect. Handrail / 80x30mm Dikd. K�peşte Ayarlı D�n�ş K�resi
LF521	Flange For Rectangular Post / Dikdörtgen Dikme Flanşı
LR81-402	40mm Strut Anchor 24cm / 40'lık Ankraj Demiri 24cm

aplication details / uygulamadetaıları

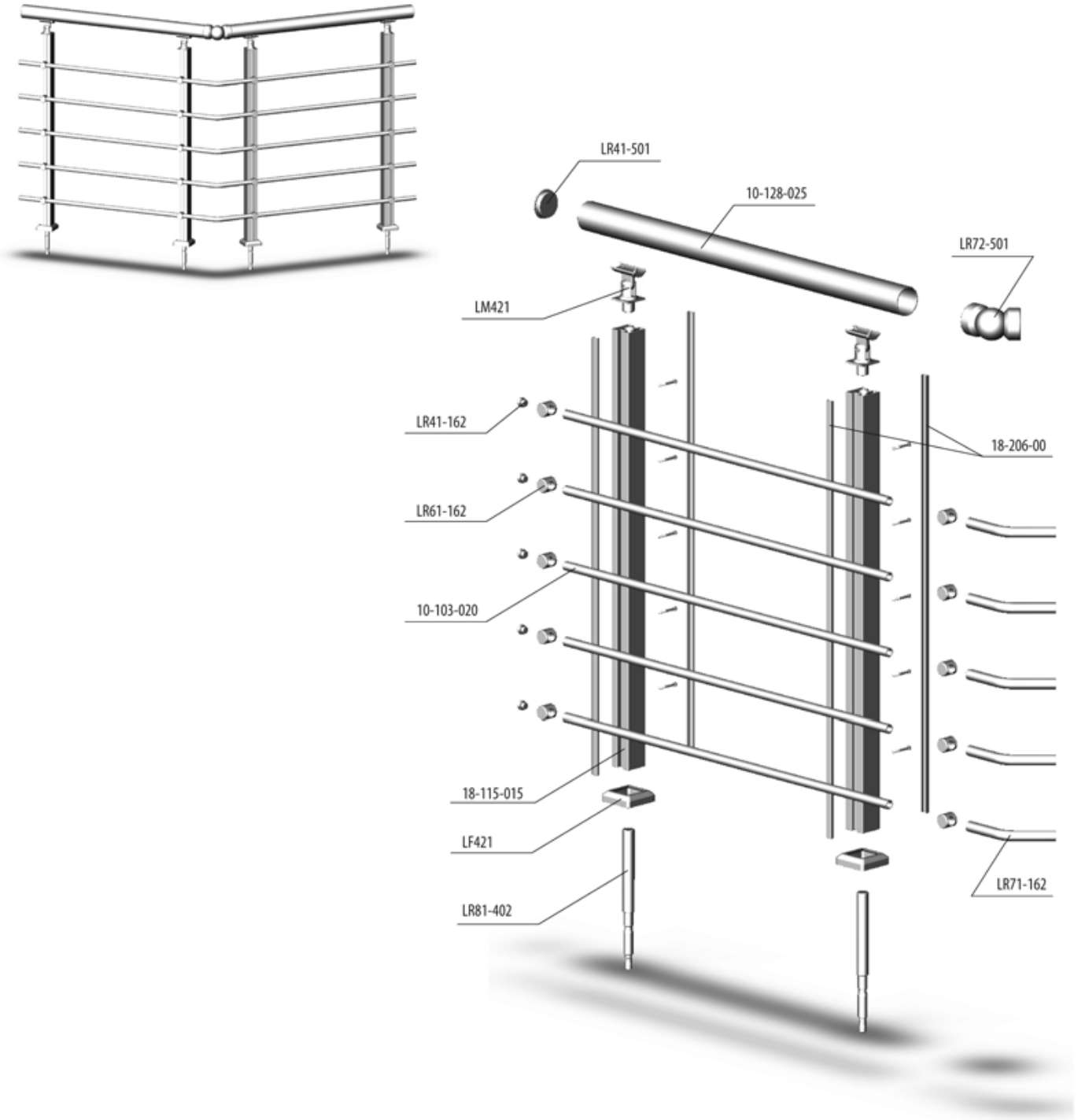

Code/Kod	Description/Açıklama
10-128-025	Ø50 Tube Profile / Ø50'lik Boru Profili
18-115-015	40 Column Profile / 40'lik Kare Dikme Profili
18-206-00	Column To Rail Profile / Dikme Çıta Profili
10-103-020	Ø16 Tube Profile / Ø16'lik Boru Profili
LM421	Regular Bracket For 40mm Square Post / Kare Dikme Üstten Mafsallı
LF421	Regular Flange For Square Post / Kare Dikme Flanşı

Code/Kod	Description/Açıklama
LR41-501	50mm Pipe Plug / 50'lik Boru Tapası
LR41-162	16mm Pipe Plug 16x2mm / 16'lik Boru Tapası 16x2mm
LR61-162	16mm Pipe Holder / 16'lik Tutamak
LR71-162	16mm Pipe 135° Tube Bend / 16'lik Dirsek 135°
LR72-501	50mm Sphere Bend / 50'lik Bilezikli Küre Dirsek
LR81-402	40mm Strut Anchor 24mm / 40'lik Ankraj Demiri 24cm

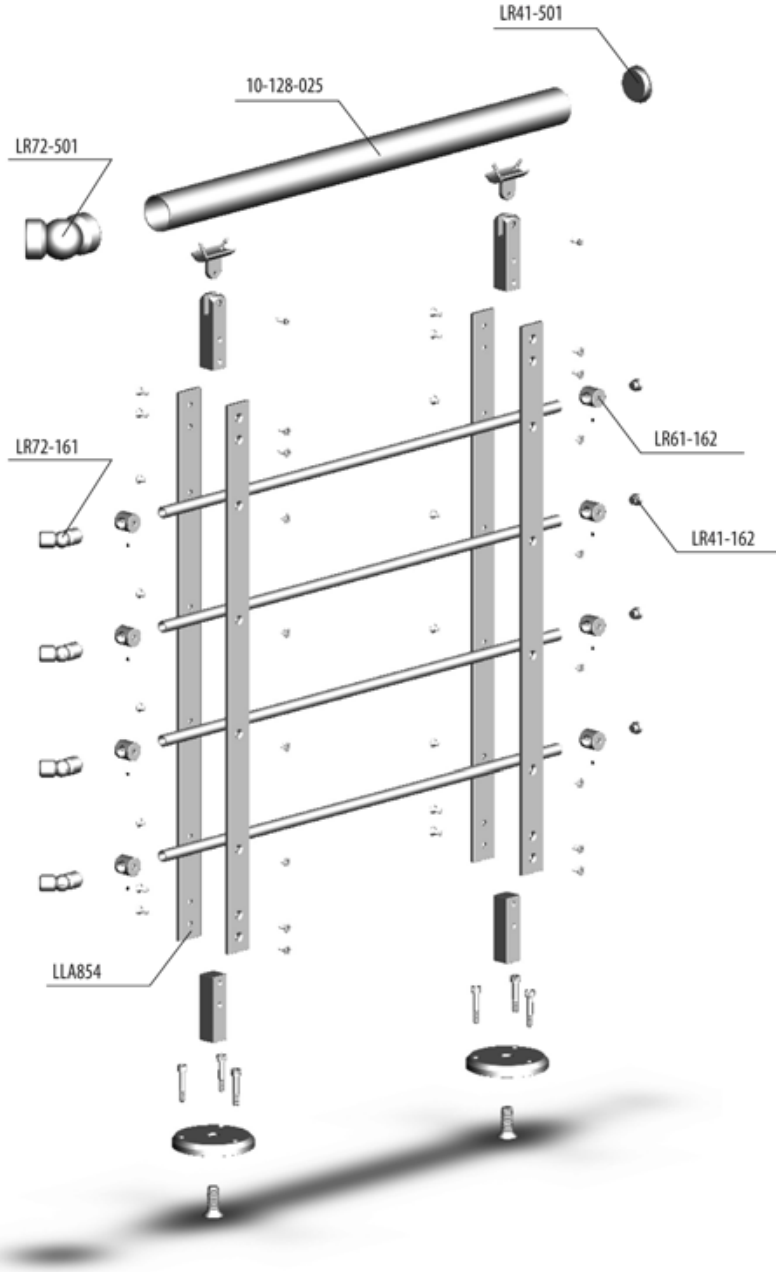

Code/Kod	Description/Açıklama
10-128-025	Ø50'lik Tube Profile / 50'lik Boru Profili
LLA 854	Flat Bar Posts / Lama Dikme
LR41-501	50mm Pipe Plug / 50'lik Boru Tapası

Code/Kod	Description/Açıklama
LR72-501	50mm Sphere Bend / 50'lik Bilezikli Küre Dirsek
LR72-161	16mm Sphere Bend / 16'lık Küre Dirsek
LR41-162	16mm Pipe Plug 16x2mm / 16'lık Boru Tapası 16x2mm
LR61-162	16mm Pipe Holder / 16'lık Tutamak

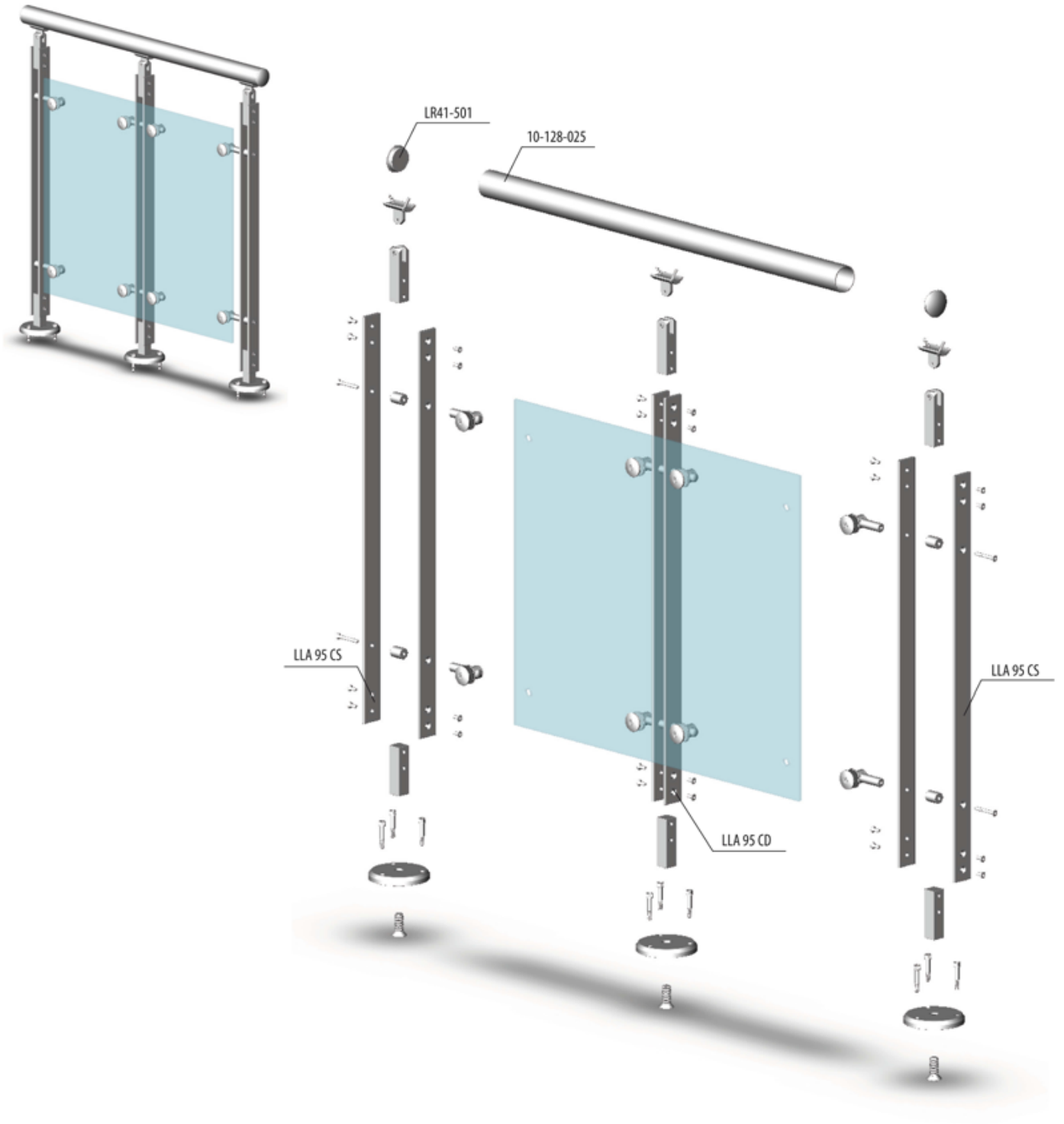

Code/Kod	Description/Açıklama
10-128-025	Ø50 Tube Profile / 50'lik Boru Profili
LLA 95 CS	Flat Bar Post / Lama Dikme

Code/Kod	Description/Açıklama
LLA 95 CD	Flat Bar Post / Lama Dikme
LR41-501	50mm Pipe Plug / 50'lik Boru Tapası

A series of horizontal dashed lines for writing notes.

A series of horizontal dashed lines for writing notes.

A series of horizontal dashed lines for writing notes.

A series of horizontal dashed lines for writing notes.

Produced by 

KURTOĞLU BAKIR KURŞUN SAN. A.Ş.

Hacıseremet Mevkii, Tem Çorlu Çıkışı Velimeşe 59880 Pk 323 Tekirdağ / TÜRKİYE

T: +90 282 684 70 00 F: +90 282 684 70 01

www.kurtogluas.com kurtoglu@kurtogluas.com

 **Lorenzoline**
aluminium profile system